

DOMESTIC HOT WATER UNIT

Air Source Heat Pump with external coil

Instruction Manual



CONTENT

1.Preface	1
2.Specification	3
1). Technical Data	3
2). Appearance and Features	4
3). Working principle	5
4). Heat pump sketch map	5
5). Dimensions	6
3. Controller Introduction	7
1).Functions of the controller	7
2).Operation	7
4.Installation Instruction	14
5.Trial Running	15
6.Maintenance	16
7.Appendix	16
1). Control board access	16
2). Wiring Diagram	17

1.PREFACE

Dear customers:

In order to use this machine safely, please read this user's manual carefully before using and installation, especially pay attention to each notice remark for usage and maintenance. Also keep it carefully for later use. Heat pump water heater is a professional machine, it may cause damage or hazard when wrong installed. Relevant installation and maintenance shall be done by technical people. Please contact our installation service for reference.



Important warning:

- 1).When using for the first time, check if all the wiring are correct before you connect the unit to power supply.
- 2).The specifications of fuse is: AC250V, 5A.
- 3).The appliance must be fitted with means for disconnection from the supply mains having a contact separation in all poles that provide full disconnection under overvoltage category III conditions, and these means must be incorporated in the fixed wiring in accordance with the wiring rules.
- 4). The running range of the heat pump:
the ambient temperature range $-7 \sim 43^{\circ}\text{C}$;
outlet water range: $12 \sim 60^{\circ}\text{C}$
the pressure of water $0.1\text{MPa} \sim 0.7\text{MPa}$.
- 5).If the power cord is damaged, please replace a new one offered from factory by professional technicians.
- 6).Power plug's rated current shall be in accordance with the model you buy.
- 7).The units must be ground wired. Never connect the ground line on neutral line or water pipe.
- 8).Product shall be singly assigned to a electrical leakage protection power .
- 9).Hot water above 50°C may be burned, we suggest that you mix cold water with hot water from water tank for use.
- 10).Any equipment must not be inserted inside the heat pump unit, in case any accident or abnormal operation.
- 11).For your safety, please DO NOT change or mend the heat pump water heater yourself.
- 12).Closed water heaters shall be marked with a statement that a pressure-relief device is to be fitted in the installation, unless it is in corporatthe appliance.
- 13).This appliance is not intended for use by persons (including children) with reduced physical, sensory or mental capabilities, or lack of experience and knowledge, unless they have been given supervision or instruction concerning use of the appliance by a person responsible for their safety.

1. PREFACE

Important warning:

- 14). The instructions shall contain the substance of the following: If the supply cord is damaged, it must be replaced by the manufacturer, its service agent or similarly qualified persons in order to avoid a hazard.
- 15). The water may drip from the discharge pipe of the pressure-relief device and that this pipe must be left open to the atmosphere; the pressure-relief device is to be operated regularly to remove lime deposits and to verify that it is not blocked;
- 16). Transport using a forklift
When transported by a fork lift, the unit must remain mounted on the pallet. The lifting rate should be kept to a minimum. Due to its top-heaviness, the unit must be secured against tipping over.
To prevent any damage, the unit must be placed on a level surface!
- 17). Manual transport
For the manual transport, the wooden pallet can be used for bottom part. Using ropes or carrying straps, a second or third handling configuration is possible. With this type of handling, care must be taken that the max. Permissible inclination angle of 60 degree is not exceeded.

Eposited and transportation

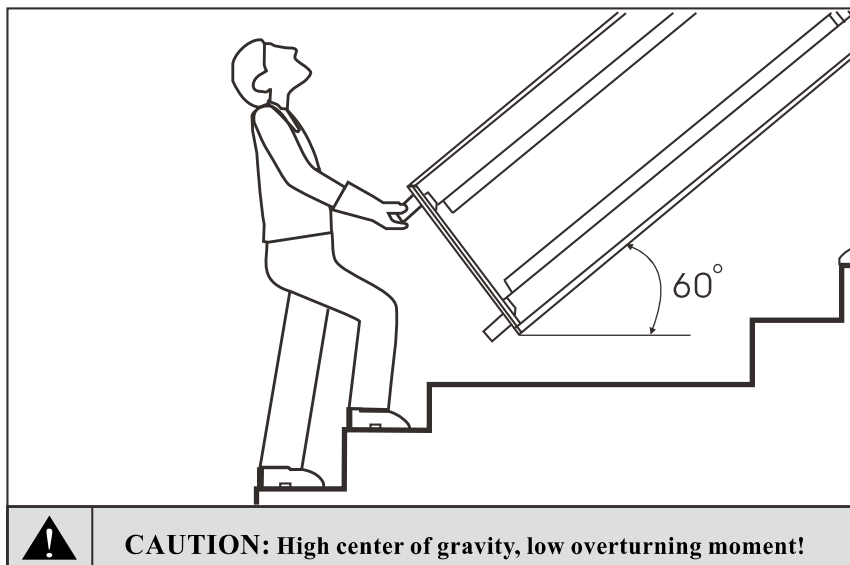

18)

Notes on environmental protection	
	<p>This product may be at the end of his life rather than the normal household waste will be sonderm at a collection point for the recycling of electrical and electronic equipment will be delivered. The symbol on the product, the instruction manual or packaging recalls.</p> <p>The materials are recycled, according to their identification. With the reuse of recycling or other forms of recovery of waste afford a important contribution to protect our environment.</p> <p>Please ask at the municipal disposal of the competent authority.</p>

2.SPECIFICATION

1).Technical Data

Model		ZR9W-200T	ZR9W-250T	ZR9W-300T	ZR9W-400T
Heating capacity	kw	3.0	3.0	3.0	3.0
Water tank volume	L	200	250	300	400
Power input	W	840	840	840	840
Running current	A	3.9	3.9	3.9	3.9
Power supply	V/Ph/Hz	220-230/1/50	220-230/1/50	220-230/1/50	220-230/1/50
Compressor number		1	1	1	1
Compressor type		Rotary	Rotary	Rotary	Rotary
Rated outlet water temperature	°C	55	55	55	55
Max outlet water temperature	°C	60	60	60	60
Air volume	m ³ /h	450	450	450	450
Air pressure	Pa	60	60	60	60
Duct diameter	mm	Φ150	Φ150	Φ150	Φ150
Noise	dB(A)	49	49	49	49
Water inlet size/outlet size	inch	G 3/4"	G 3/4"	G 3/4"	G 3/4"
Net dimensions	mm	Φ560×1720	Φ640×1610	Φ640×1820	Φ640×2223
Package dimensions	mm	625×625×1860	705×705×1750	705×705×1960	705×705×2350
Net weight	kg	83	86	97	107
Gross weight	kg	102	105	120	129

Notice:

- 1.The technology parameter is tested as below:20°C for dry temperature outdoor, 15°C for wet temperature outdoor; inlet water 15°C; outlet water 55°C.
- 2.Refer to the label on the unit if the data different from this table.

2.SPECIFICATION

2) Appearance and Features



* **High efficiency:** smart design make normal working efficiency more than 300%.

* **Easy installation and operation:** With LCD display, easy to handle and check all kind of temp and operation information.

* **Stainless steel tank:** ensure clean water to users.

- **Waste heat is useful heat**

The standard heat exchanger of the hot-water heat pump enables direct connection to a second heat generator, e.g. a solar heating system or a boiler.

- **Dehumidification in the recirculating air mode**

Dehumidified air in the laundry room supports laundry drying and prevents moisture-induced damage.

- **Cooling in the recirculating air mode**

The room air is extracted from the storage room or a wine cellar, subsequently cooled and dehumidified in the heat pump and finally re-introduced into the room. Recreation rooms, boiler rooms or utility rooms are ideal installation sites. The air-ducts leading through warm sections must be insulated to prevent the formation of condensation.

2.SPECIFICATION

3).Working principle

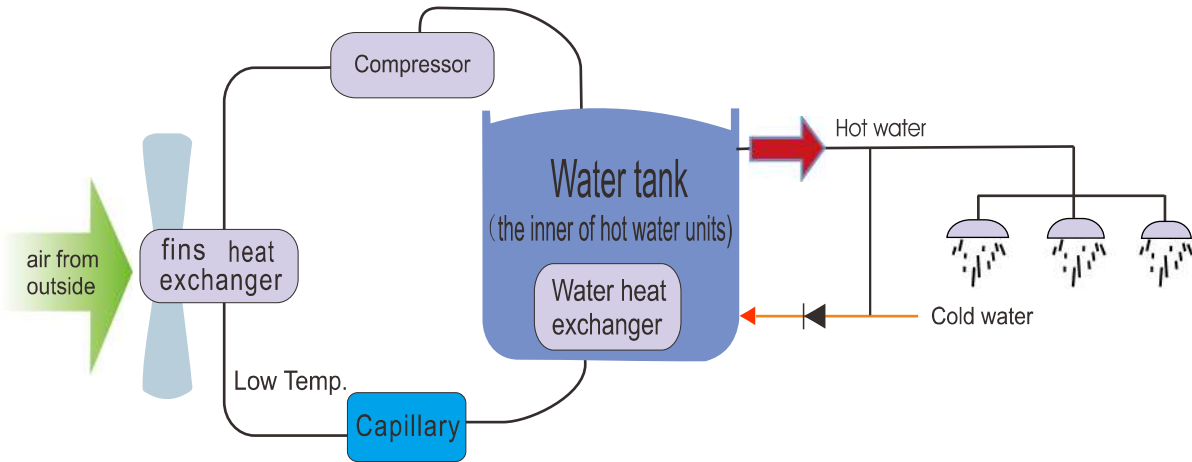

4).Heat pump sketch map

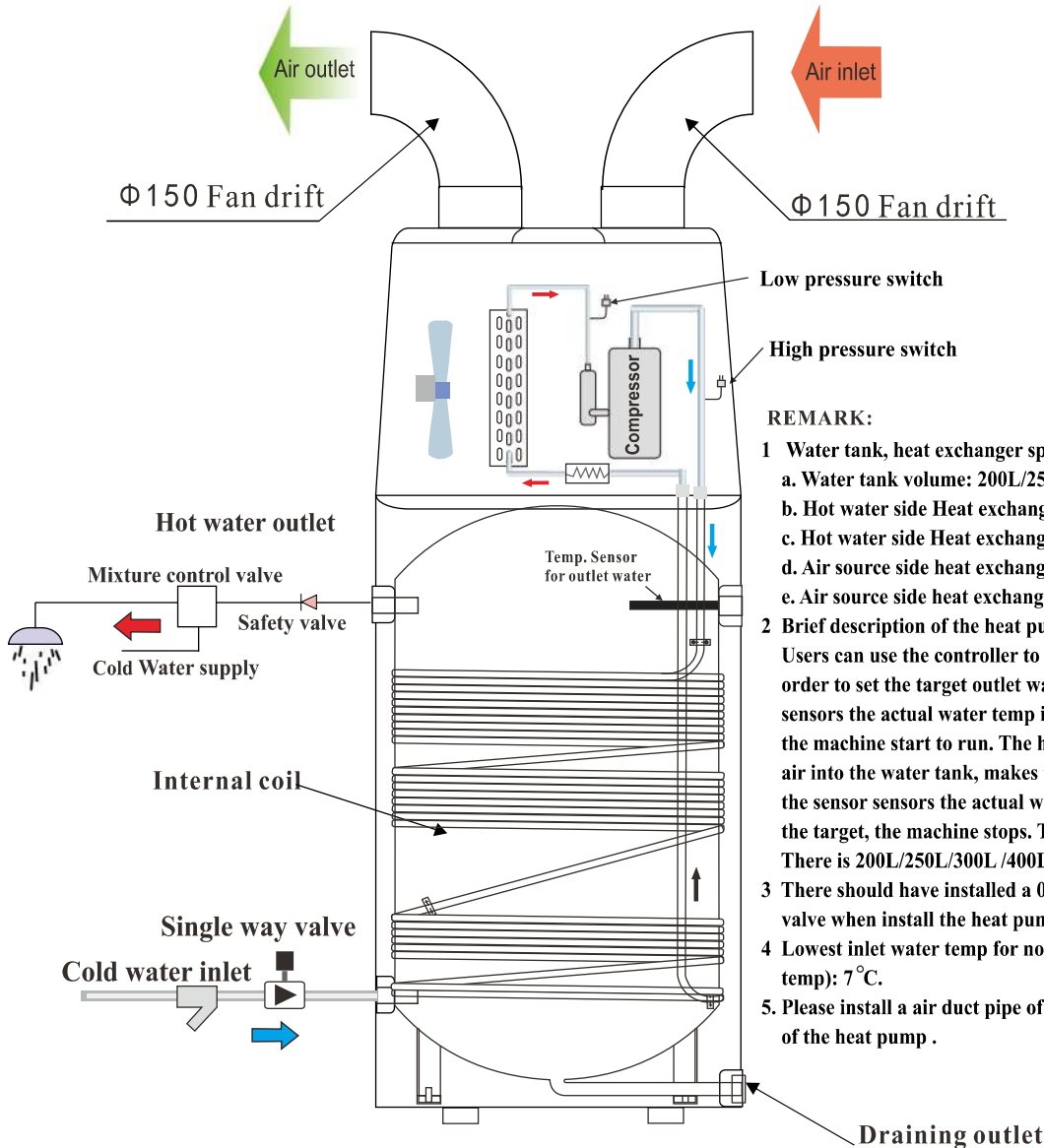

2.SPECIFICATION

5). Dimension (Measure: mm)

TYPE SIZE	ZR9W-200T	ZR9W-250T	ZR9W-300T	ZR9W-400T
A	1650	1535	1745	2145
B	1185	1070	1280	1683
C	1025	910	1120	1523
D	Φ 560	Φ 640	Φ 640	Φ 640
E	450	450	450	450
F	250	250	250	250
G	32.5	32.5	32.5	32.5
H	*450	*450	*450	*450
T	*925	*830	*1020	*1423
M	1025	910	1120	1523
N	1135	1020	1230	1633
V	925	830	1020	1423
P	40	40	40	40

Notice: The data with "*" mark only belong to unit has solar coil built in.

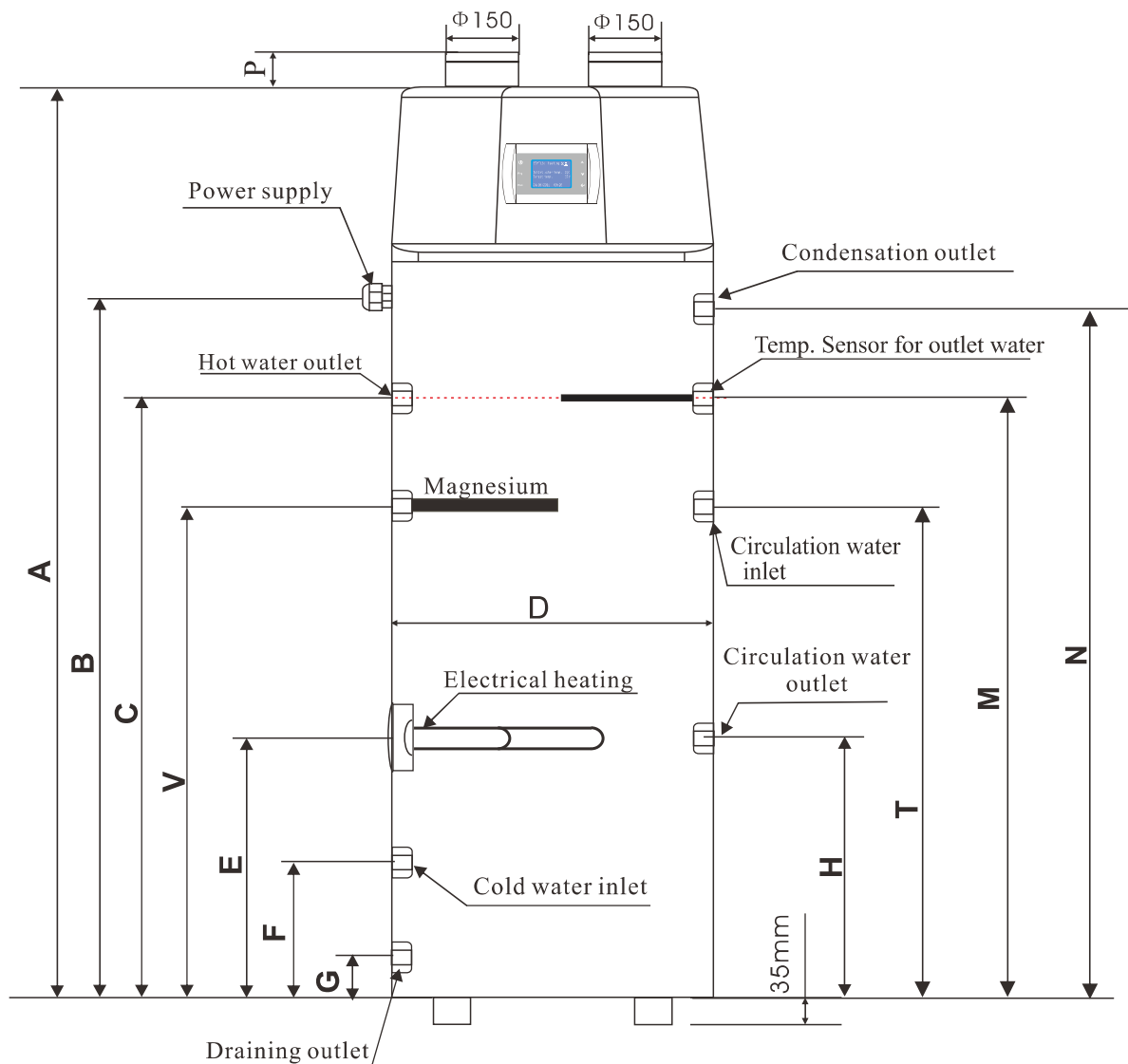

3.CONTROLLER INTRODUCTION

1).Function of controller

User Interface and Usage as the following:

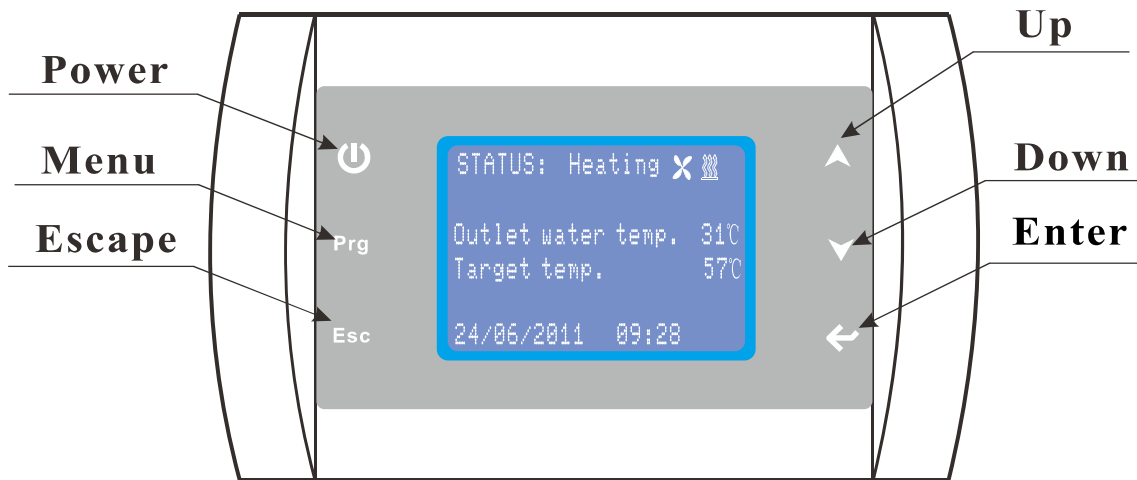

Stand by state

Operation Instruction:
All parameter settings can only be adjusted /setted under stand-by state.

STATUS: Standby X
Outlet water temp. 31C
Target temp. 55C
24/06/2011 09:28

Fig.1

Start-up state

STATUS: Heating X [heating icon]
Outlet water temp. 31C
Target temp. 55C
24/06/2011 09:28

Fig.2

2).Function Screen

Press "**Prg**" button from Main Screen to access Function Screen, see **Fig.3**.

Press " ▲ " or " ▼ " to choose setting of 4 functions, then press " ← " to enter setting of chosen function .

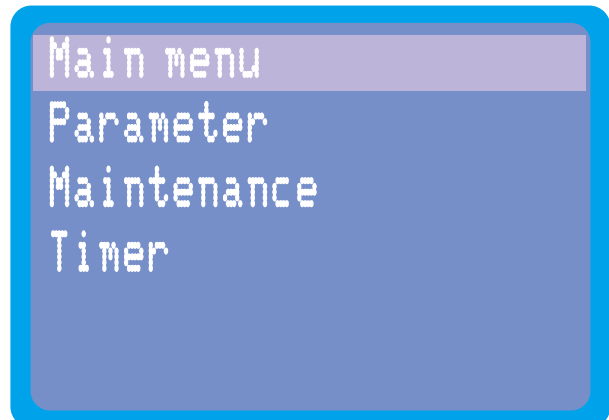

Fig.3

2.1)Main Menu

Press " ← " button to access the Main Menu, see **Fig.4**.

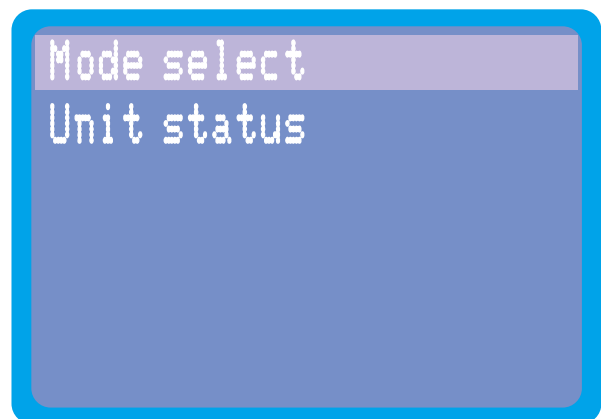

Fig.4

2.1.1)Mode Select

Press " ← " to enter FIG. 5 interface , for changing the setting of " Aux. Heating " and " Fan Mode" function . You may change status between ON and OFF by pressing " ← ", press " ESC " to confirm and return to main interface.

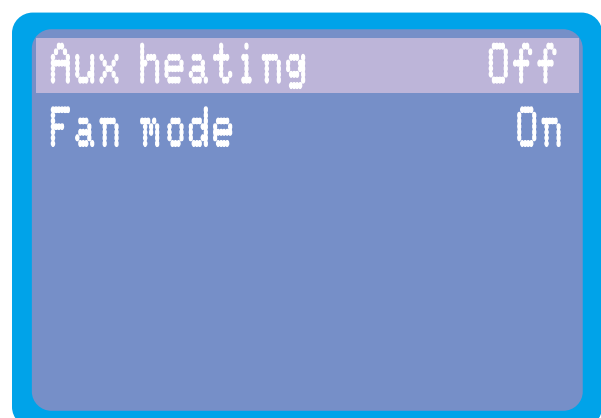

Fig.5

3.CONTROLLER INTRODUCTION

2.1.2)Unit Status

Press " ▲ " or " ▼ " to move the cursor to " Unit Status" , then press " ← " to confirm and enter to interface of FIG.6.

This interface display the current real /actual running status , parameter data are not adjustable .

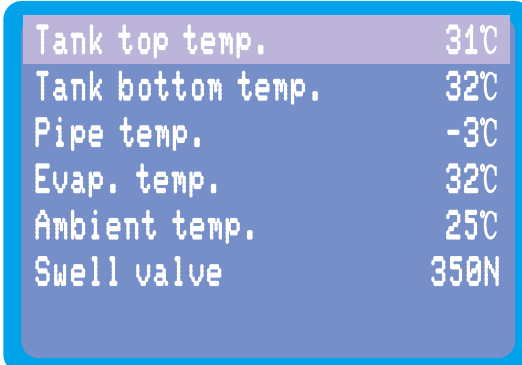

Tank top temp.	31°C
Tank bottom temp.	32°C
Pipe temp.	-3°C
Evap. temp.	32°C
Ambient temp.	25°C
Swell valve	350N

Fig.6

2.2)Parameter

Choose "Parameter "from Function Screen to access "Parameter "Screen, then press "ENTER" button to access the "Parameter "see Fig.7.

2.2.1)Operation

Press " ▲ " or " ▼ " to move the cursor to "Operation" then press " ← " to confirm and enter interface of FIG.8.

Press " ▼ " or " ▲ " to change the parameter value , then press "ESC" to confirm . Press " ESC" again to return to last interface .

"Out water temp"adjustable range:10-60°C

" Δ T1 (heating)"adjustable range:2-15°C



1.0 Operation
2.0 Aux heating
3.0 Defrost
4.0 Save
5.0 Disinfection
6.0 Swell valve

Fig.7

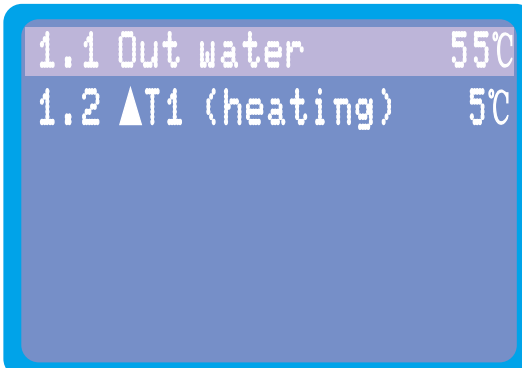

1.1 Out water	55°C
1.2 ΔT1 (heating)	5°C

Fig.8

2.2.2)Aux Heating

Press " ▲ " or " ▼ " to move the cursor to "Aux Heating" ,then press " ← " to confirm and enter interface of FIG.9.

Press " ▲ " or " ▼ " to choose parameter value , then press " ESC" to confirm changes , press "ESC" to return to last interface.

"Start temp."adjustable range:30~90°C

"Start delay"adjustable range:0~90min

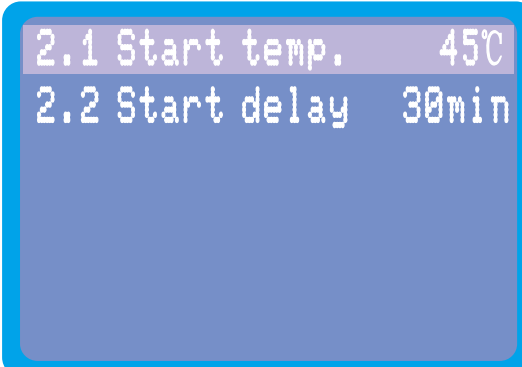

2.1 Start temp.	45°C
2.2 Start delay	30min

Fig.9

3.CONTROLLER INTRODUCTION

2.2.3) Defrost

Press " ▲ " or " ▼ " to move the cursor to "Defros", then press " ← " to confirm and enter interface of FIG.10. Press " ▲ " or " ▼ " to choose parameter value , then press " ESC " to confirm changes , press "ESC" to return to last interface.

"Def.cyc"adjustable range:30~90M(M for minutes)

"Def.in"adjustable range:-30~0℃

"Def.out"adjustable range:2~30℃

"Max time"adjustable range:1~12M

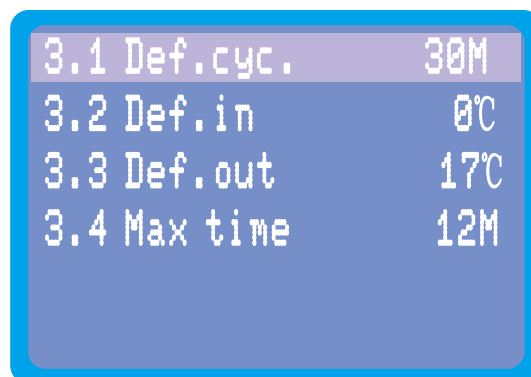

3.1 Def.cyc.	30M
3.2 Def.in	0℃
3.3 Def.out	17℃
3.4 Max time	12M

Fig.10

2.2.4) Save

Press " ▲ " or " ▼ " to move the cursor to "Save", then press " ← " to confirm and enter interface of FIG.11. Press " ▲ " or " ▼ " to choose parameter value , then press " ESC " to confirm changes , press "ESC" to return to last interface.

Adjustable value : "0" or "1"

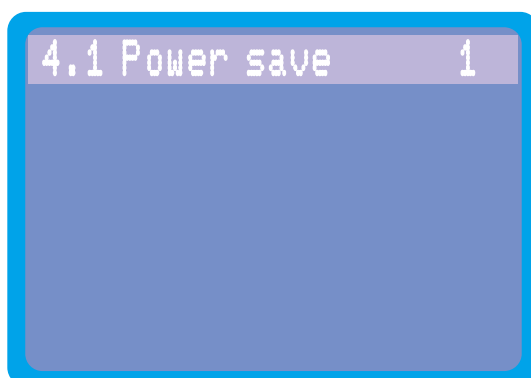

4.1 Power save	1
----------------	---

Fig.11

2.2.5) Disinfection

Press " ▲ " or " ▼ " to move the cursor to "Disinfection", then press " ← " to confirm and enter interface of FIG.12. Press " ▲ " or " ▼ " to choose parameter value , then press " ESC " to confirm changes , press "ESC" to return to last interface.

"Target temp."Adjustable value :30~70℃

"Maintain time"Adjustable value :0~90M

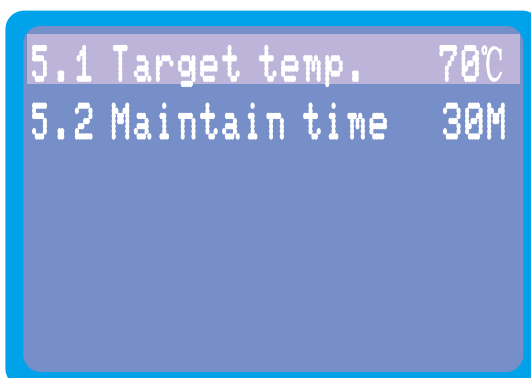

5.1 Target temp.	70℃
5.2 Maintain time	30M

Fig.12

2.2.6) Swell valve

Press " ▲ " or " ▼ " to move the cursor to "Swell valve", then press " ← " to confirm and enter interface of FIG.13. Press " ▲ " or " ▼ " to choose parameter value , then press " ESC " to confirm changes , press "ESC" to return to last interface.

" Mode" have " Auto" and "Manual " 2 options to choose.

"Over Heat"Adjustable value :-20~20℃

"Adjust step"Adjustable value :100~500N



6.1 Mode	Auto
6.2 Over heat	5℃
6.3 Adjust step	350N

Fig.13

3.CONTROLLER INTRODUCTION

2.3)Maintenance

Display the failure history record

failure error code

failure occur date and time

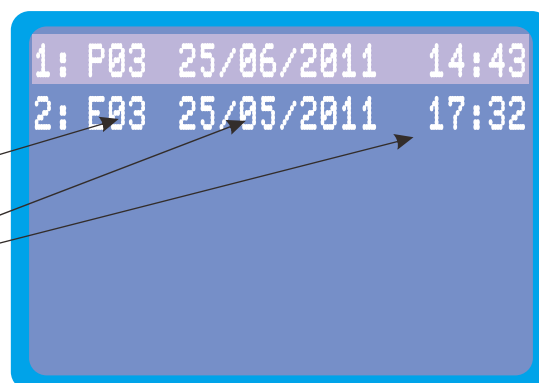

Fig.14

2.4)Timer

Choose "TIMER " from FUNCTION SCRREN to access "TIMER" screen, then press "ENTER"button to access the "TIMER"

2.4.1) "Date" and " Clock" setting .

Press " ▲ " or " ▼ " to move the cursor to "Date" or " Clock" ,then press " ← " to confirm and enter interface of FIG.15.

Press " ▲ " or " ▼ " to choose parameter value , then press " ESC" to confirm changes , press "ESC" to return to last interface.



Fig.15

2.4.2)TIMER ON/OFF SETTING

You may set both "Timer 1" and" Timer 2" 2 period time at the same time .

2.4.2.1) TIMER 1 ON/OFF SETTING

Move the cursor to "Timer 1 on " , press " ← " once , " × " flashes . Then press " ▲ " or " ▼ " , " ✓ " flashes , pressor " ← " once , timer on function start to take affect . At the moment, you may press " ▲ " or " ▼ " to set the time of Timer On, then press " ← " or " ESC" to confirm .

Move the cursor to"Timer 1 off " , press " ← " once , " × " flashes . Then press " ▲ " or " ▼ " , " ✓ " flashes , press " ← " once , timer off function start to take affect . At the moment, you may press " ▲ " or " ▼ " to set the time of Timer Off, then press " ← " or " ESC" to confirm .

2.4.2.2) TIMER 2 ON/OFF SETTING

The setting operation is same as "TIMER 1 ON/OFF"

3.CONTROLLER INTRODUCTION

2.5) Malfunction Display

During standby or running state , if malfunction happens to the system, the system will stop to show the malfunction code as the following:

To show the malfunction code (refer to malfunction code table)



Fig.16

Ordinary malfunctions and Solutions:

Failure	Controller on the water tank	Indicator light	Cause	Solutions
Stand by		Off		
Unit running		On		
Lower tank water temp. sensor failure	P01	1 on 1 off	The temp. sensor is open or short circuit	Check and replace the temp. sensor for the upper tank water
Upper tank water temp. sensor failure	P02	2 on 1 off	The temp. sensor is open or short circuit	Check and replace the temp. sensor for the lower tank water
Inlet evaporator. temp. sensor failure	P03	3 on 1 off	The temp. sensor is open or short circuit	Check and replace the temp. sensor for the evaporator inlet
Outlet evaporator temp. sensor failure	P04	4 on 1 off	The temp. sensor is open or short circuit	Check and replace the temp. sensor for the evaporator outlet
Ambient temp. sensor failure	P05	5 on 1 off	The temp. sensor is open or short circuit	Check and replace the temp. sensor for the Ambient
High pressure protect	E01	6 on 1 off	1,too much refrigerant in the unit 2,bad heat exchanger on the air	1. discharge the redundant gas 2. clean the air side heat exchanger
Low pressure protect	E02	7 on 1 off	1,the refrigerant is not enough 2,block on the filter or capillary 3,water flow is not enough 4,expansion sensor is broken	1.check if there is any leak and refill the gas 2.replace the filter or capillary 3.clean the water side exchanger or discharge the air in the water loop 4.use new expansion valve
AUX-heating thermal protect	E03	8 on 1 off	The electronic heating temp. protect	Check the water supply or tank whether have enough water
Communication failure	E08	On	Communication failure between wire controller and main board;	Check the wire connection between the wire controller and the main board
Defrosting	Defrosting indicate	flash		

3.CONTROLLER INTRODUCTION

Factory default setting on controller :
all parameters can only be adjusted under stand-by status.

Fig.	Description and content:	Setting range /option	Default value	Remark	
1	Stand-by status: Outlet water temperature:	/	/	Actual tested value,not adjustable	
	Stand-by status: Target/setting water tempertaure	10~60° C	55° C	Adjustable	
2	Running status: Outlet water temperature	/	/	Actual tested value,not adjustable	
	Running status: Target/setting water temperature	/	/	Actual tested value,not adjustable	
3	available functions:Main	as select option	/	/	
4	main menu: Mode select/Unit status	as select option	/	/	
5	Mode select :	as select option	/	/	
	Aux heating	on/off	off	Adjustable	
	Fan mode	on/off	off	Adjustable	
6	Unit status	Tank top temperature.	/	Actual tested value,not adjustable	
		Tank bottom temperature	/	Actual tested value,not adjustable	
		Pipe temperature	/	Actual tested value,not adjustable	
		Evaporator temperature	/	Actual tested value,not adjustable	
		Ambient temperature	/	Actual tested value,not adjustable	
		Swell valve	/	Actual tested value,not adjustable	
7	Parameter	1.0 Operation			
		1.1 Out water	10~60° C	55° C	Adjustable
		1.2 ▲T1(heating)	2~15° C	5° C	Adjustable
		2.0 Aux heating			
		2.1 Start temperature	30~90° C	55° C	Adjustable
		2.2 Start delay	0~90 *5min	40 *5min	Adjustable
		3.0 Defrost			
		3.1 Defrost cycle	30~90 minute	45minute	Adjustable
		3.2 Defrost in temperature	-30~ 0° C	-.7° C	Adjustable
		3.3 Defrost out temperature	2~30° C	13° C	Adjustable
		3.4 Max time	1~12 Minute	8 Minute	Adjustable
		4.0 Save			
		4.1 Power save	0(NO)/1(YES)	1(YES)	Adjustable
		5.0 Disinfection			
		5.1 Target temperature	30~70° C	65° C	Adjustable
		5.2 Maintain time	0~90Minute	30Minute	Adjustable
		6.0 Swell valve			
		6.1 Mode	Auto/Manual	Auto	Adjustable
		6.2 Over heat	-20~20° C	5° C	Adjustable
		6.3 Adjust step	100~500 N	350 N	Adjustable
8	Maintenance	see "Ordinary malfunctions and Solutions"		Actual running record, not adjustable	
9	Timer	Date	/	Adjustable	
		Clock	/	Adjustable	
		Timer 1 on	√ (YES)/ ×(NO)	×(NO)	Adjustable
		Timer 1 off	√ (YES)/ ×(NO)	×(NO)	Adjustable
		Timer 2 on	√ (YES)/ ×(NO)	×(NO)	Adjustable
		Timer 2 off	√ (YES)/ ×(NO)	×(NO)	Adjustable
10	Alarm (P01~E08)see"Ordinary malfunction and Solutions" table	/	/	Actual running record, not adjustable	

4.INSTALLATION INSTRUCTION

Please pay attention to following information before installation

- 1). Applied working temp of heat pump -7 ~ 43℃
- 2). Check whether the power supply and wire meet the standard of the unit.
- 3). Do not alter the power wiring or socket. Do not change the GND connection of the system.
- 4). Do not insert hands or object into the vent of heat pump, it may cause dangerous or damaged.
- 5). Ensure that water tank is full filled with water before turn the heat pump on.
- 6). The Maximum temp of outlet water can up to 60 ℃, strongly recommend to mix up some water when using water.
- 7). Heat pump should be checked and maintained once a time every year by a qualified technical people. And all power should be disconnected when servicing.
- 8). The magnesium stick should be replaced 1 or 1.5 year according to the water quality.
- 9). Please provide serial No. on the nameplate, when asking for after- sale service.

Installation Instruction

- 1). The air inlet and outlet should be free from obstacles and strong wind.
- 2). The bearing surface should be flat, able to bear weight of the unit and suitable for installing the unit vertically without increasing noise or vibration.
- 3). No flammable gas is leaked nearby.
- 4). It is convenient for piping and wiring.
- 5). This heat pump unit can be installed at Garden, Garage , Balcony or other place, but make sure there is enough space for proper installation and maintenance. Find Reference installation pic in below.

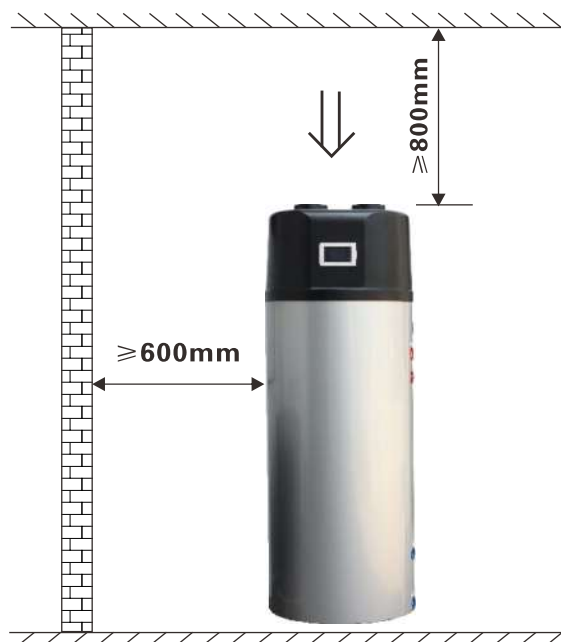

4.INSTALLATION INSTRUCTION

6). The air inlet and outlet are at the top side, main unit should not place at an open air.

Avoid the rain to enter the vents.

The air inlet and outlet can connect the $\phi 150$ air duct for air ventilation, see below pic.

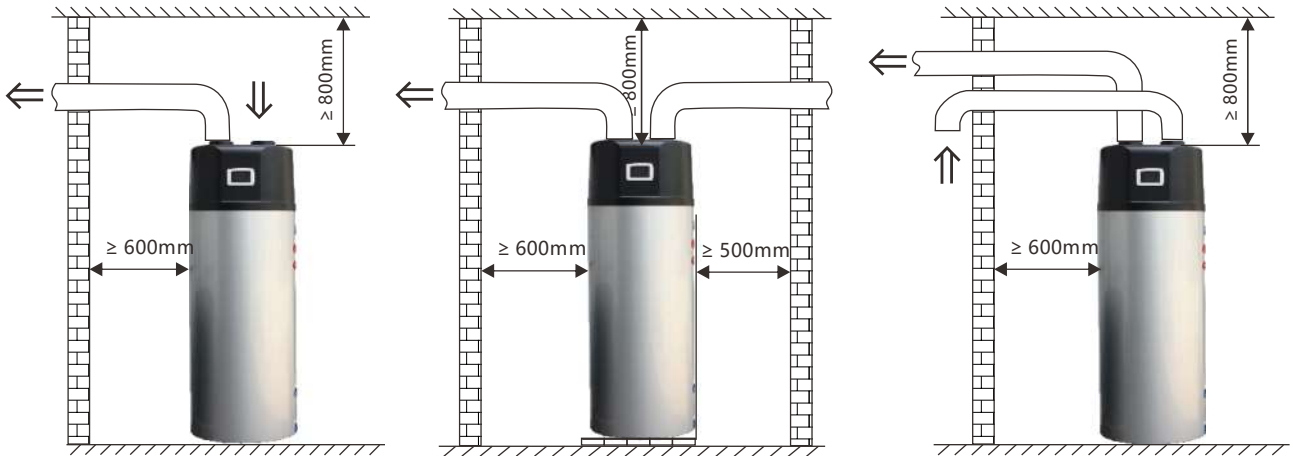

5.TRIAL RUNNING

Trial Running

- 1). Check if the heat pump is placed in a well ventilated and installed in a dry place.
- 2). Check if the water tank is full of water, and open the water outlet tap till water flows out.
- 3). Make sure the water pressure is normal (0.1Mpa ~0.7 Mpa).
- 4). Check the power supply is normal or not, (voltage range 220v +/-10 %)
- 5). Check if all the equipped parts are well secured and well connected.
- 6). A suitable circuit breaker must be connected.
- 7). Check whether the condensation and drain pipe are connected well.
- 8). After power is switched on, check if the LCD controller displays normally.

6.MAINTENANCE

Maintenance

Heat pump water heater is a high automatic equipment, please perform regular inspection termly. If the unit can be long-term and efficiently maintenance, the operating reliability and service life will have an unexpected increase.

- 1).The extra water filters should be cleaned regularly to ensure clean water quality of the system, and to avoid damage caused by dirty water filter blocking.
- 2).Frequently check the power supply and electrical wiring system is solid or not, whether electrical components are abnormally working, if yes, should timely maintenance and change for a new one.
- 3).Perform regular checks of the water supply system, check whether the tank safety valve, liquid level controller and exhaust devices work properly, so as to avoid air into the system , and reduce the water cycle volume, thus affect the heating function and operation reliability.
- 4).Check whether pumps and water valves are normal working or not, whether water tubing and water pipes connector are leakage or not.
- 5).The unit and around should remain clean , well-ventilated. To maintain a good effect of heat exchange, DON'T put things around the unit.
- 6).If the unit stops for a longer time, should drain all the water in the pipeline, cut off power supply, and sets the protective equipment. When re-run the unit, complete inspection is a must before reboot.
- 7).Water tanks need to remove the Water scale after some time (normally two months, according to the water quality of local place). It can clean the scale by the drain hole.

7. APPENDIX

Appendix

1). Controlling board access

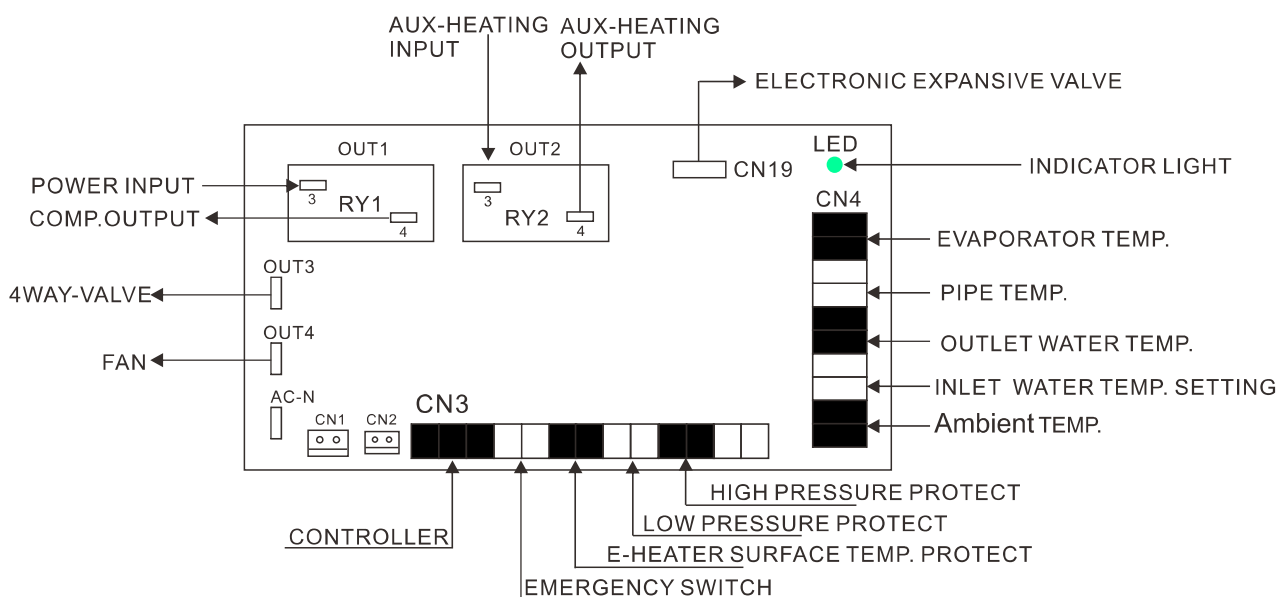

7.APPENDIX

2). Wiring diagram

