

EVI 80 °C HEAT PUMP WATER HEATER

Installation & Instruction Manual

MODEL:

SWBH-15.0H-B/P-S

CONTENTS

I .To our customers-----1

II .Product Introducing-----2

III .Work principle-----3

IV .Performance Data-----4

V .Dimension-----5

VI .Operation introductions-----6

VII .Wire Circuit Diagram-----11

VIII .Installation instructions-----12

IX .Maintenance-----16

Dear Sir:

In order to use this machine safely, please read this INSTRUCTION MANUAL carefully before using and installation. Heat pump water heater is a professional machine, it may cause damage or hazard when wrong installed, it should be installed by a competent person in accordance with the relevant standards for the country of use.

WARNING:***ELECTRICAL POWER MUST BE SWITCHED OFF
BEFORE STARTING ANY WORK ON JUNCTION BOXES***

- 1. Before installing the heat pump, please ensure that the electrical supply corresponds to the specification indicated on the unit's rating label before proceeding with the connection in accordance with the wiring diagram supplied. Please check carefully on the rating label and the wiring diagrams that pasted on each heat pump unit.**
- 2. The unit must be EARTHED to avoid any risks caused by insulation defects. It is forbidden to start any work on the electrical components without switching off the electrical supply to the unit. Electric leakage switch protection device MUST be installed.**
- 3. It is forbidden to start any work on the electrical components if water or high humidity is present on the installation site.**
- 4. When the unit is being connected, ensure that no impurities are introduced into the pipe work and the water circuits.**
- 5. All maintenance or repairmen of the heat pump must be performed by competent technicians.**
- 6. It could be hurtful when generated hot water reaches 52 °C, please mix with cold water before using.**
- 7. To prevent any damage to the fan or any accidents, it is forbidden to put your fingers or any other objects into the air outlet. Kids or children should be kept away from the heat pump.**
- 8. This appliance is not intended for use by persons (including children) with reduced physical, sensory or mental capabilities, or lack of experience and knowledge, unless they have been given supervision or instruction concerning use of the appliance by a person responsible for their safety.**
- 9. Children should be supervised to ensure that they do not play with the appliance.**

Product Introducing

⊙ **Safe and Reliable**

Unlike traditional electric water heater, heat pump water heater do not directly generate heat by electricity, it use less electricity to move heat from one place to another, electric circuit is separated from water circuit, which is also not easy for electric shock, inflammable, explosion and poisoning! Safer and more reliable!

⊙ **Highly efficient & Energy saving**

Heat pump water heater absorb plenty of heat from free ambient air, and can supply same hot water volume as electric heater. Electricity consumption is only 1/4 compared to electric heater, very energy saving!

⊙ **Environmental Friendly**

Heat pump not only use less electricity to get heat from ambient air, but are also able to combine using with solar equipment, will not cause pollution and no poison gas exhausting.

⊙ **All Round The Year Hot Water**

Heat pump water heaters are not affected by seasonal climate, provide hot water all year round even in cloudy or rainy days!

⊙ **Durable and long-lasting time**

Heat pump spare parts such as compressor and 4-way-valve are made by famous brand manufacturer, and casing panel is corrosion resistance, very durable and long-lasting time.

⊙ **Convenient Installation**

Installation site for heat pump can be the roof, the garage, the kitchen, the storing room, the basement and so on, very convenient on installation.

⊙ **Wide Application**

Heat pump water heaters are applicable for family, factory, school, hotel, hospital, and laundry, etc. Wide application for different using request.

Work principle

The low temperature and low pressure refrigerant gas come from the evaporate to the compressor, After the compressor compress it , the refrigerant gas became high temperature and high pressure. Then the gas come into the water condensation into liquid, emit a lot of condensation heat,condensing heat absorbed by water, making the water temperature increased, and then the liquid refrigerant come through the expansion valve, with a fan , the evaporate heat in the air, after all evaporation , the low pressure compressor refrigerant gas inhalation in the compressor, after working through the compressor, a high temperature and high pressure of the refrigerant gas from the compressor to exhaust emissions, such reciprocating cycle.

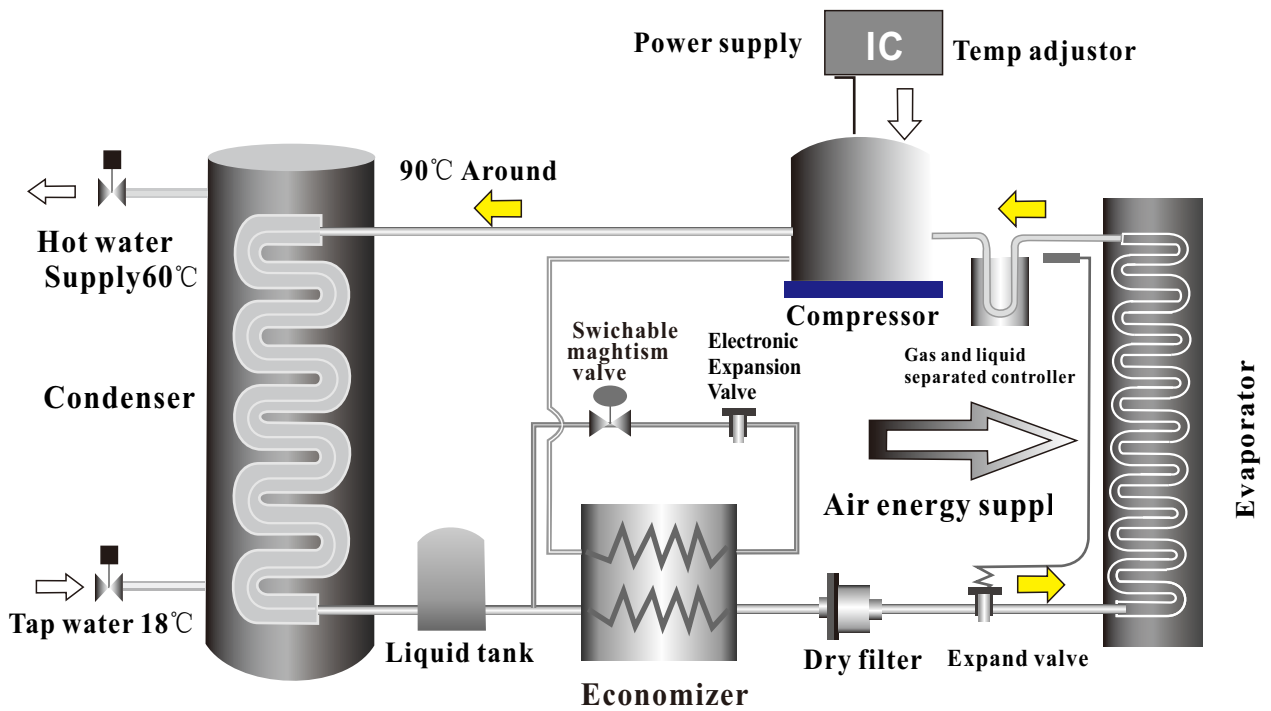

Performance Data

Model	SWBH-15.0H-B/P-S	
Rated heating capacity(w)	15000W	
Power supply(V/Ph/Hz)	380V/3PH/50Hz	
Input power(kw)	4.0KW	
Running current(A)	5.5Ax3	
Circulating unit hot water generated(L/h)	heat up water: 40℃ → 80℃	370L/h
	heat up water: 60℃ → 80℃	640L/h
Thermostat factory setting(°C)	60℃	
Thermostat maximum setting(°C)	85℃	
Water connections(inch)	1	
Compressor quantity	1	
Fan motor quantity	2	
Fan motor input(w)	360	
Fan speed(rpm)	1380	
Noise(dB(A))	63	
Net dimension(mm)	1300*500*1370	
Net weight(kg)	160	

Measuring conditions:

Heating: dry bulb 20℃, wet bulb 15℃, water inlet 40℃, water outlet 45℃ .

The dimension for low ambient air source heat pump water heater
SWBH-15.0H-B/P-S

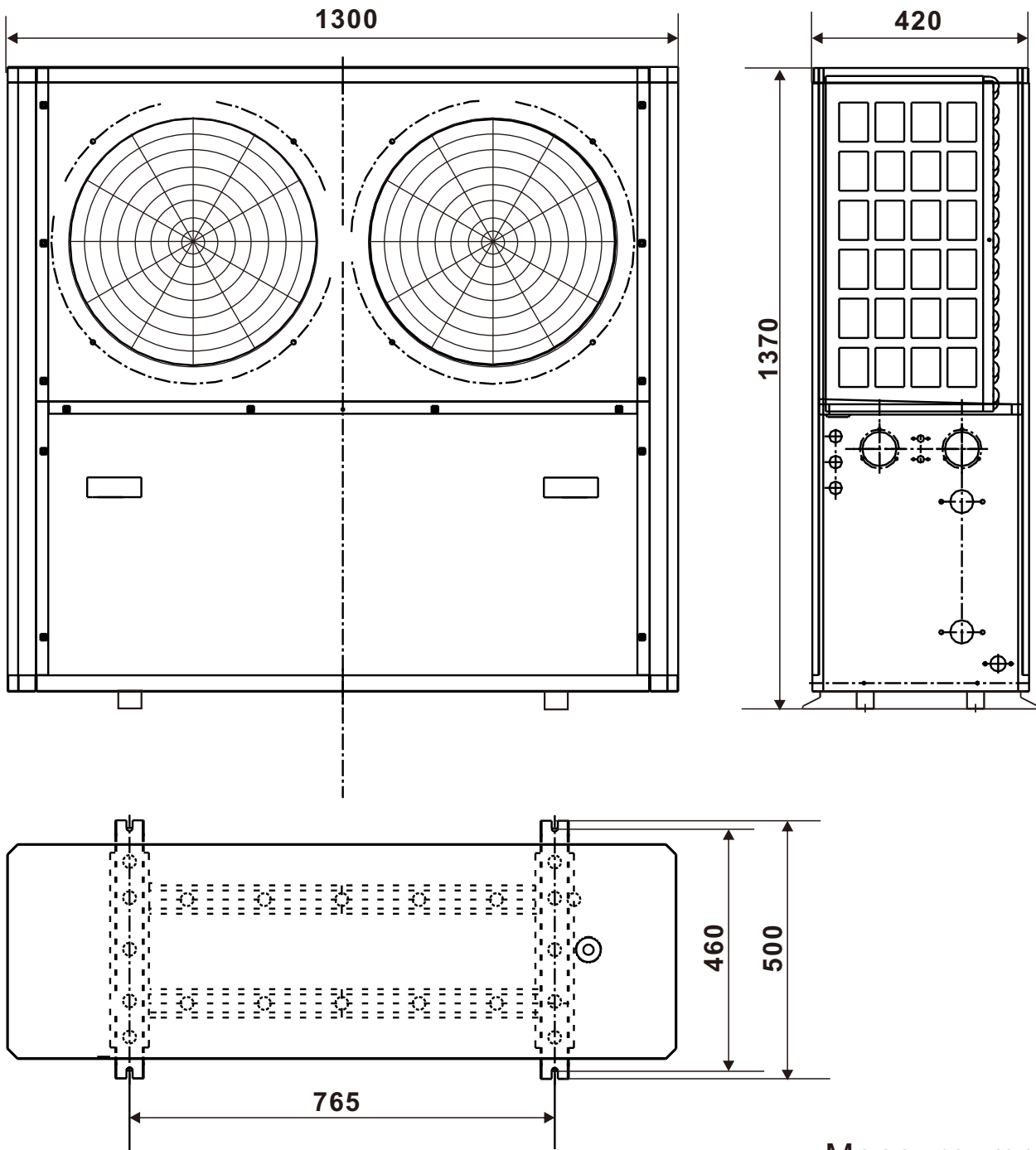

Measure: mm

Operation introductions

1. Initialization

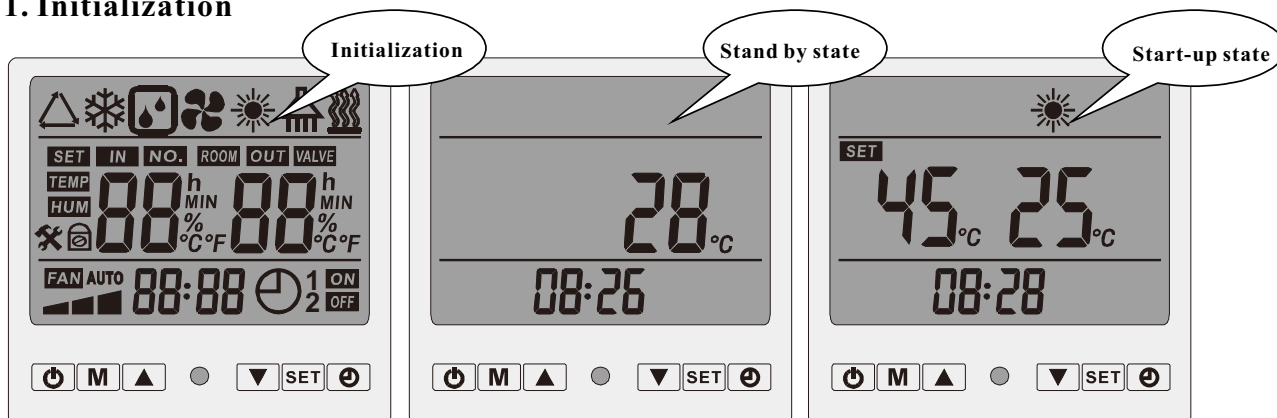

- ◎ On Start-up state, actual water in temperature displays on the right side, setting temperature displays on the **left** side. Stand-by state only shows the actual testing temperature on the right side.
- ◎ On start-up state, the heating symbol always displays, stand-by state do not display any heating symbol, but heating symbol long flashing when heat pump is defrosting.
- ◎ The background lightens up when pressing any key; disappear if no operation for 10 seconds.

2. Definition of LCD Controller Buttons.

2.1 " "for ON /OFF and Return

- 2.1.1 On main interface, Press “ ” to turn on or turn off the heat pump.
- 2.1.2 After entering parameter or clock setting, press “ ” once to return to main interface.

2.2 " "for Status Inquiry

- 2.2.1 Press once to check each actual temperature value or the open steps for 2 expansion valve.
- 2.2.2 Long press for 5 seconds to enter parameter setting.

2.3 " " & " "for Up and Down

- 2.3.1 Under start-up state, press and to directly adjust/set water IN temperature ,setting range (20°C-80°C)
- 2.3.2 Press and or to check or change the parameters or check each temperature value or open step for electric expansion valve.

2.4 " "for Clock and Auxiliary Heater setting

- 2.4.1 Press once to enter Clock setting, meanwhile press or to change the time.
- 2.4.2 Long press for 5 seconds to switch on or off the auxiliary heater function . When auxiliary heater symbol is displayed, system allows to start the Auxiliary heater function.

Operation introductions

2.5 " "for Timer

2.5.1 Totally you may set 2 sets of different Timer On and Timer Off.

2.5.2 Press " " and "▲" or "▼" to set the 1st set of timer on and timer off.

2.5.3 Long press " " and "▲" or "▼" to set the 2nd set of timer on and timer off.

2.5.4 Long press " " for five seconds and press "SET" to cancel the timer.

3. Wire Controller Operation

3.1 Press " " once to turn on or turn off the heat pump.

3.2 Long press "▲" AND "▼" (at the same time) for 3 seconds to lock or unlock the keyboard.

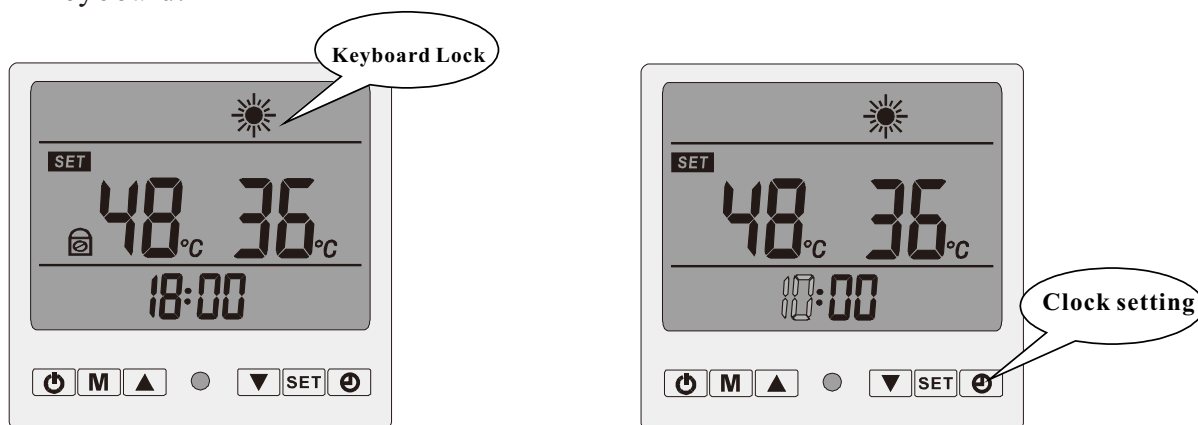

3.3 Clock Setting

3.3.1 On main interface, press "SET" once, to enter clock setting interface,

3.3.2 press "▲" or "▼" to change the clock setting.

Press "SET" once to enter interface of clock setting, when the hour time for clock setting shows and flashes. , press "▲" or "▼" to set the hour .

After setting hour time, press "SET" once, then only minute time shows and flashes, then you can press "▲" and "▼" to set the minute time for the clock.

After setting the minute time, press "SET" once to confirm and save all the setting to current live clock time, meanwhile to exit the setting interface and return the main interface.

Operation introductions

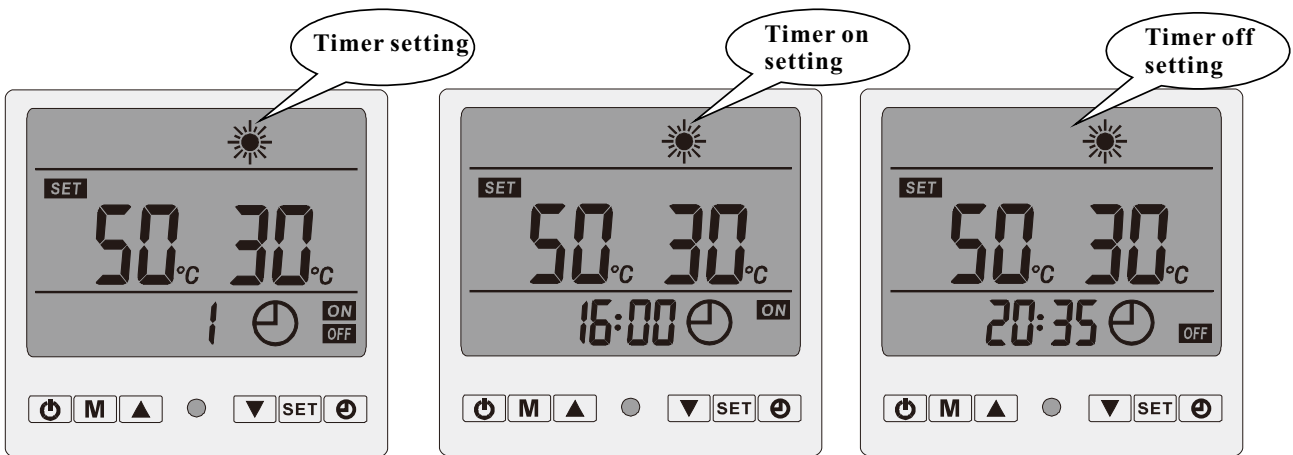

3.4 Timer On & Timer Off Setting

3.4.1 Press once to enter 1st set timer interface, when 1、ON、hour flashes, press or to set hour, press once again and 1、ON、minute flashes, press or to set minute, then press again to confirm the setting.

3.4.2 Long press for 5 seconds to enter interface of 2nd set timer, then 2、ON, hour flashes, press or to set hour. Then press once again, 2、OFF, minute flashes, press or to set the minute. Press or to set one to confirm setting.

3.5 Press both and at the same time for 5 seconds to enter force defrost, heating symbol long flashes.

On enquiry state, stop operation within for 10 seconds to return to main interface, press directly also to return to main interface.

3.6 On any interface, press and or may check each temperature value and expansion valve open steps.

SN	Definition
0	Water in temperature
1	Water out temperature
2	Economizer in temperature
3	Economizer out temperature
4	Outdoor ambient temperature
5	Suction air temperature
6	Outdoor coil temperature
7	Exhaust air temperature
8	1 # expansion valve open step
9	2 # expansion valve open step

Operation introductions

3.7 System Parameter & Status Inquiry

Long press **[M]** for 5 seconds and check each parameter value by pressing **[▲]** or **[▼]**

SN	Explanation	Setting range	Default	Remark
0	water in	20 - 80℃	55℃	
1	heating return differential	1 - 12℃	5℃	
2	Electric heater start delaying time	15 - 90 MIN	30 MIN	
3	Electric heater return differential	1℃ - 20℃	5℃	
4	defrost enter temperature	-30 - 0℃	-7℃	
5	defrost exit temperature	1 - 30℃	15℃	
6	defrost interval	30-90 MIN	45 MIN	
7	maximum defrost time	1-12 MIN	8 MIN	
8	1 # electric expansion valve	0/1	0	0: auto 1: manual
9	1 # electric expansion valve initial value	10-48	35	actual pulse =set*10
10	1 # electric expansion valve target overheat	-F - F	5	
11	2 # electric expansion valve	0/1	0	0: auto 1: manual
12	2 # Electric expansion valve initial value	10-48	35	actual pulse =set*10
13	2 # electric expansion valve target overheat	-F - F	5	
14	exhaust air temperature protect temperature	100-125℃	115℃	
15	memory	0/1	1	0: yes 1: no
16	Maximum Water Inlet temp	60 - 80℃	65℃	
17	Minimum Water Inlet temp	20 - 40℃	35℃	

3.8 Failure code and parameter tables

Code	Description	Code	Description
E01	Water flow failure	E10	Economizer in sensor failure
E02	High pressure failure	E11	Economizer out sensor failure
E03	Low pressure failure	E12	Ambient sensor failure
E04	Exhaust air too high protect	E13	Suction air sensor temperature
E05	Phase failure	E14	Exhaust air sensor failure
E06	Electric heater temperature to high	E15	Outdoor coil sensor failure
E07	Communication failure	P01	1 st class anti-free protect
E08	Water in sensor failure	P02	2nd class anti-free protect
E09	Water out sensor failure		

Operation introductions**3.9 Setting about S1 & S2 switch**

S1 Switch---Second Set Point

S2 Switch----Long distance demand

3.9.1 Second Set Point available when S1 switch has well connected.

At the same time, water temp set point setting decided by ambient temp, Parameter 16 and Parameter 17. (Both 16 & 17 Parameter would be adjusted)

Parameter 16 (maximum setting range 65~80 ° C)

Parameter 17 (minimum setting range 40~55 ° C)

A. When ambient temp < 5° C, set point temp refer to the data of Parameter 16

B. When ambient temp > 15° C, set point temp refer to the data of Parameter 17

C. When 5° C ≤ ambient temp ≤ 15° C, Set point temp = Data of Parameter 16 - (Data of parameter 16 - data of parameter of 17)/(15-5)*(Ambient temp - 5)

For example, when ambient temp is 18 deg c, Parameter 16 data is 60 deg c, Parameter 17 data is 20 deg c. Then set point temp = 60 - (60 - 20)/(15 - 5) * (18 - 5)

3.9.2 When S1 disconnected, set point temp control by LCD controller. (Refer to the setting of Parameter 40 (default setting 50 deg c).**3.9.3 Heat pump will turn on when S2 switch has well connected. However, S2 well connected, and suddenly press the off button on the LCD controller. Heat pump will stop for 3 minutes. After 3 minutes heat pump continue to turn on if S2 Still has been connected.****3.9.4 The timer function is out of validity when S2 switch is connected.****3.9.5 Heat pump turns off when S2 switch is disconnected. Meanwhile, need to use LCD controller to switch on/off the heat pump.**

Wire Circuit Diagram

Applicable model: SWBH-15.0H-B/P-S

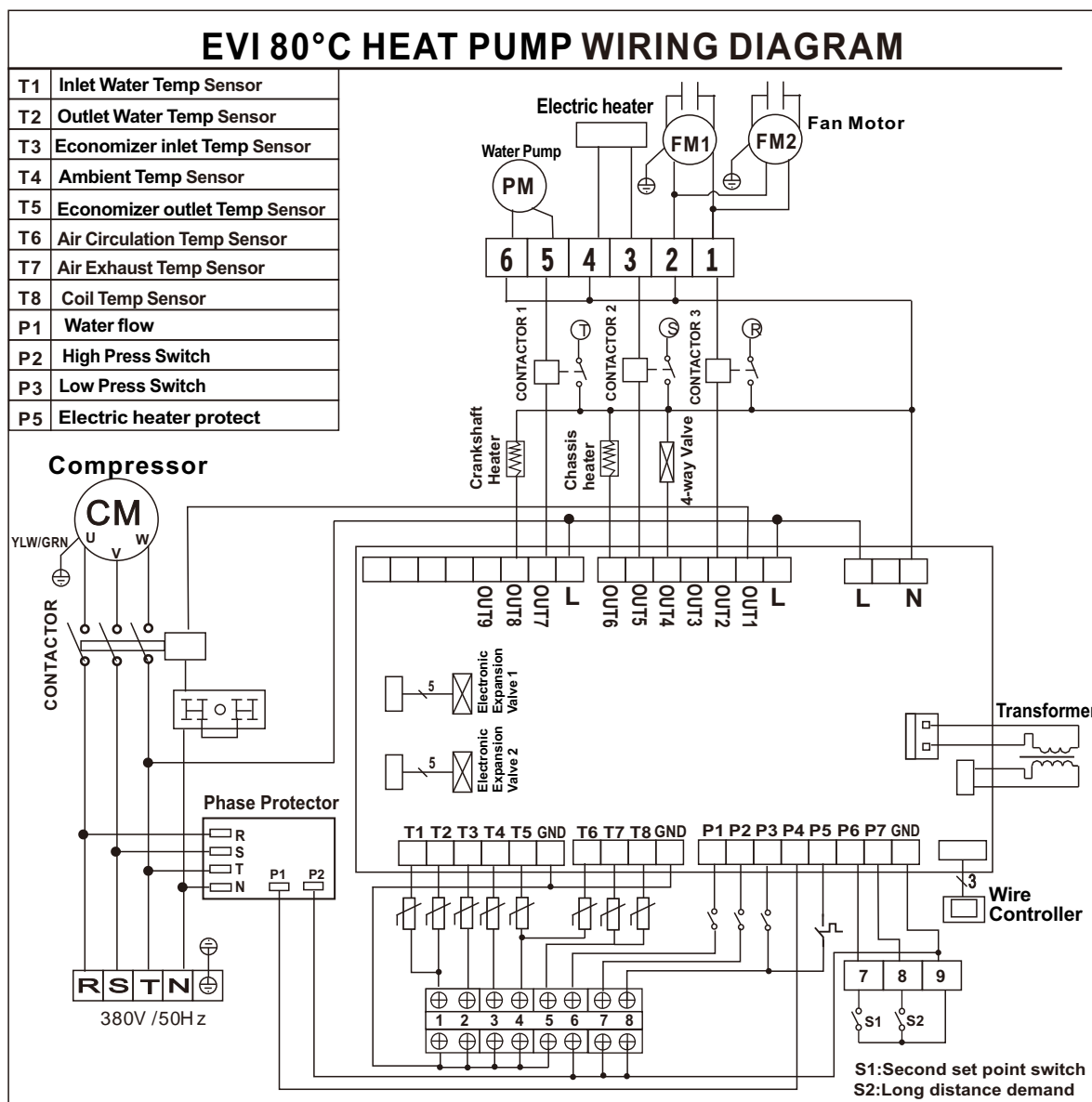

Note: crank heaters marked in diagram are optional parts according to customer request!

Installation instructions

1. Unit installation

1). Installation location

Host unit

- ☐ Should be installed in a larger & well-ventilated place.
- ☐ Installation location should ensure unhindered access outlet (inlet & outlet shown as below).
- ☐ Install gutter or set up positions near the outfall, to facilitate the drainage.
- ☐ The installation base or bracket should be steady, to ensure the smooth operation of running units.
- ☐ Make sure the unit is vertical after installation, and no incline.
- ☐ Make sure not to install the host unit in the any conditioner of pollution, corrosive gases, sun and fallen leaves, etc.
- ☐ Installation location must not next to place of incendive , easy-explosion and fire .
- ☐ Installation must pay attention to the distance between the barriers shown in below picture (pay attention to arrow direction).

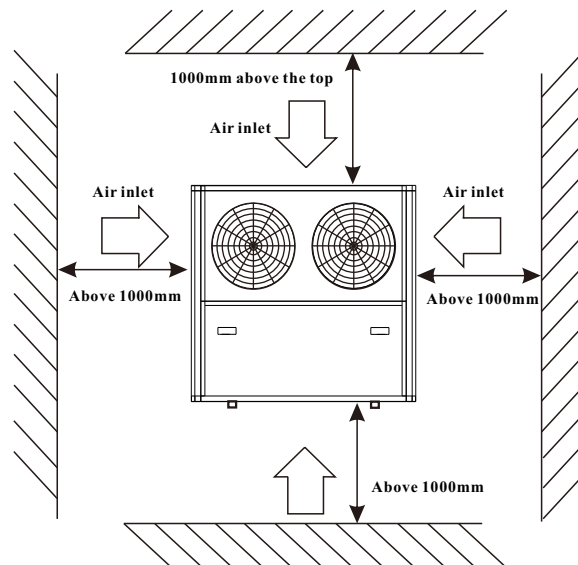

Water tank

- ☐ Water tanks should be placed where ambient temperature is above 0°C .
- ☐ Can be installed outdoors or the top of the building (based on the size of water tanks and the load-bearing capacity of the building and so on).
- ☐ Do not install water tanks in the pollution, corrosive gases place.

2). Unit installation

- ☐ Units base can be installed as cement concrete structures, steel brackets can also be used, add the shockproof rubber pads , make the base surface flat.
- ☐ Units can be designed based on the working performance.
(See Table of technical performance parameters)
- ☐ Unit should have drain or drainage inlets.
- ☐ Normally required to install in the place where setted cement concrete base.

Installation instructions

2. Pipeline connecting

Installation notes:

- ☐ Water drain pipes, overflow pipes should be installed next to the drainage inlets to facilitate drainage, vent valve should be installed on vent pipes.
- ☐ Repair valve should be installed in front of the electromagnetic valve on the pipeline system, which is convenient for future repair.
- ☐ User water pressure should less than 0.6 Mpa.
- ☐ All pipelines should choose metal pipe (such as stainless steel, with Lining Plastic and lining stainless steel and thin-walled copper pipe or, etc.). The use of plastic pipe (such as the PP-R, ABS, etc.) should consider the pipeline expansion between the host unit and water tanks.
- ☐ Water supply and pause valves may need to keep warm in the winter (according to the local winter temperature) to avoid the broken of water supply and pause valve.

Water system installation

- ☐ All the pipeline tubing should be matched as shown on the manual, and in accordance with national corresponding construction standards.
- ☐ Installation of water pipes should be straight and flat, pipeline collocation should be rational, ensure to minimize bending; reduce the resistance loss of the water system.
- ☐ Pipeline and connecting parts are not allowed a leakage phenomenon.
- ☐ After the installation of circulating pipe between tap water pipes, host unit and water tanks, should carry out water leakage testing, and eject the sewage to ensure the system's cleanness.
- ☐ If no water leakage, keep the hot water pipe warm.

3. Project example:

Application of heat pump water heater engineering systems have different forms. Here are two kinds of stand-alone group water heating system, only for your reference.

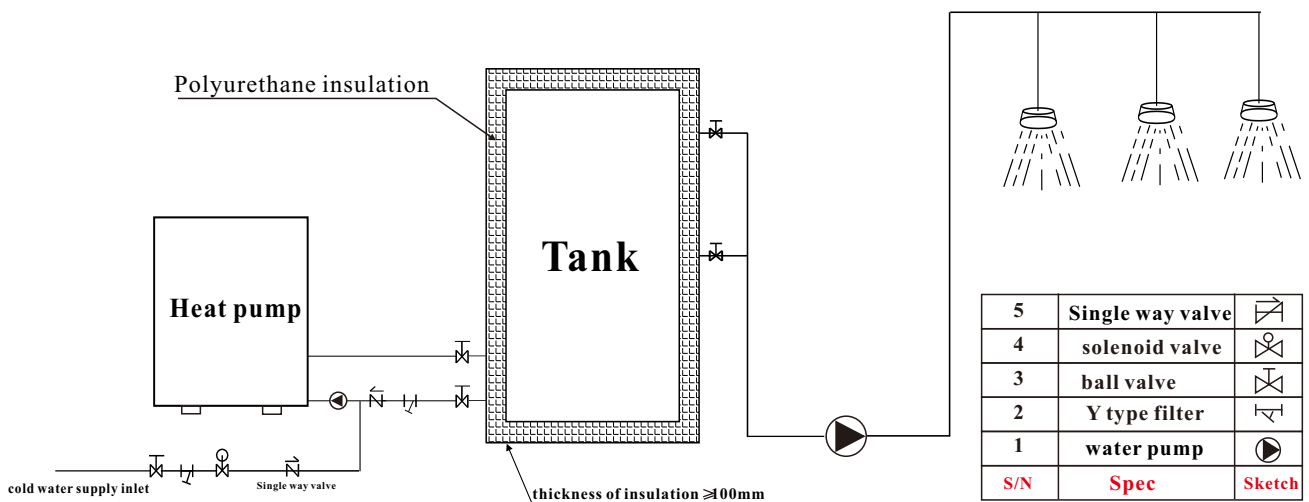

WARNING!

Due to the high temp heat pump could offer much hotter water (70-80 deg c) than the usual heat pump (60 deg c).

The water piping and insulation of water heat exchanger should be 1 or 2 times more thicker and more stronger. Better to be more than 50mm.

Highly suggest to use waterproof insulation piping when the unit install outdoor.

All water piping, valve, water flow switch , circulation pump use in high temp heat pump must be Allow to work between 0 to 100 deg c. Due to the high temp heat pump could offer max 70- 80 deg c hot water.

The tank connect to high temp heat pump should be difference from the one use in usual heat pump (60 deg c hot water outlet).

A air valve or a pressure relief valve should be add in the tank. And insulation of water tank must be thicker than 100mm.

Running Test and operation

1. Preparatory work before the running test.

a) Inspection of heat pump water heater units:

- Check if the unit appearance and the pipeline system were damaged during transport.
- Check if there is air exist in the water pipes, if yes, should empty all the air inside by the manual exhaust valve and the exhaust valve on the water pumps.
- Check if the fan rotor interference the fan fixing board and fan protection net.

b) Check the electricity distribution System

- Check if the power supply same as shown on manual and rating label.
- Check if all the power supply and control wiring are all well connected, check if the wiring is connected as wiring diagram and reliability of earth wiring.

c) Check Pipeline system

- Check the pipeline system, make sure the water supply pipes, water return pipes, pressure gauges, thermometers, valves, water flow switch are safe and correct.
- Check if having opened all the valves that should be opened, and having closed all valves that should be closed.
- Check if all necessary attemperators are good.

Running Test and operation

2. Running test

This running test must be performed by professional staff!

- ☐ Overall test can be run if the entire system inspection is conformed to regulations.
- ☐ Connected to power, start the heat pump, host unit delays three minutes then auto-start. For three-phase power supply unit, first check whether the fans and pumps' rotary direction correct or not, if not, immediately shut down the power and adjust phase sequence. Measure the compressor operation current, and if any abnormal noise. Check whether the unit conform to the requirements, run for a period of time (general 3 days), after that, the unit can be used normally.

3. Normal operation

- ☐ Heating process: start - up - water pumps runs - water flow switch inspection --- Fan operation compressor operation (when the low water level cut off, water supply induction valve opens)
- ☐ Operation Control:

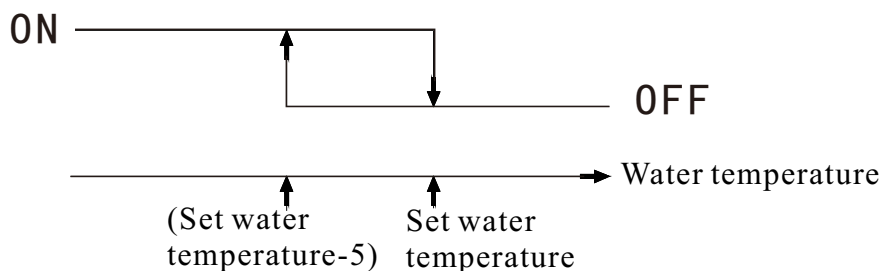

- ☐ Water level control: When the low level switch disconnect, open the water supply induction valve to supply enough water, meanwhile stop the water supply pump. Open the water supply pump when high level switch closed, After high-level switch closed for two minutes, open water supply induction valve (at least 2 minutes).
- ☐ When water pump is on and the high level switch cut off, if water temperature $<$ (set Temperature - 5 degrees), shut down water supply for tanks, If water tank temperature $>$ (temperature - 2 degrees) then open the water supply induction valve, after high-level switch closed for two minutes stop the water supply induction valve. When water pumps stopped, whatever conditions, should supply enough water. (Water supply switch on at 2 minutes).
- ☐ For the first power-on boot, the circulating water pump, compressor, fan motor runs after low level switch closed.
- ☐ During the unit operation, circulating pump open. When the unit stopped, the circulating pump will be delayed 30 seconds then stop functioning.
- ☐ When water pumps open, meanwhile open water return induction valve, 10 minutes later, test the return water temperature, when the return water temperature $>$ (water temperature - 5 degrees), the return water induction valve stops. If the return water temperature $<$ (tank water temperature - 10 degrees), open the water return valve so that the water supply pump constantly store the hot water. When water supply pump closed, shut down the water return valve at the same time.
- ☐ For normal start-up, the 4-way valve cut off, only when defrosting, the unit will work in normal.

Maintenance

Heat pump water heater is a high automatic equipment, please perform regular inspection termly. If the unit can be long-term and efficiently maintenance, the operating reliability and service life will have an unexpected increase.

- 1.The extra water filters should be cleaned regularly to ensure clean water quality of the system, and to avoid damage caused by dirty water filter blocking.
- 2.Users should pay attention for usage and maintenance to below : all units' protection devices are set up before leaving factory, do not make any adjustment by yourself.
- 3.Frequently check the power supply and electrical wiring system is solid or not, whether electrical components are abnormally working, if yes, should timely maintenance and change for a new one.
- 4.Perform regular checks of the water supply system, check whether the tank safety valve, liquid level controller and exhaust devices work properly, so as to avoid air into the system, and reduce the water cycle volume, thus affect the heating function and operation reliability.
- 5.Check whether pumps and water valves are normal working or not, whether water tubing and water pipes connector are leakage or not.
- 6.The unit and around should remain clean, well-ventilated. Regularly clean (1-2 month)the side air heat exchanger to maintain a good effect of heat exchange.
- 7.Frequently check whether each part of the unit work normal or not, check whether there is oil on the pipeline joints and charging valve to ensure that no refrigerant leakage.
- 8.Do not piling up debris around the unit, so as not to block from air inlet and outlet, the unit around should be kept clean the dry, well-ventilated.
- 9.If the unit stops for a longer time, should drain all the water in the pipeline, cut off power supply, and sets the protective equipment.When re-run the unit, complete inspection is a must before reboot.
- 10.When unit failure, and the user can not resolve the problem, please call our Company in local maintenance department, in order to promptly send people for maintenance.
- 11.Host condenser cleaning.We propose to use 50°C-60°C, and 15% hot phosphoric acid for condenser cleaning, launch the circulating pump of the host unit for three hours' cleaning, finally rinse with water three times. (Propose to back up a 3-way connector when installing the pipeline, block one joint),in order to clear the connection pipe. Do not use corrosive cleaning fluid for condenser cleaning.
- 12.Water tanks need to remove theWater scale after some time (normally two months, according to the water quality of local place).

EVI 80°C Heat Pump-Water Heater
