

AIR SOURCE HEAT PUMP WATER HEATER

Installation & Instruction Manual

Model:

SWBC-40.0H-A-S

SWBC-45.0H-A-S

SWBC-90.0H-A-S

CONTENTS

I .To our customers(before installation)-----1

II .Product Introducing-----2

III .Work principle-----3

IV .Performance Data-----4

V .Dimension-----4

VI .Operation introductions-----7

VII .Appendix-----11

VIII.Wire Circuit Diagram-----11

IX .Installation instructions-----13

X .IMaintenance-----17

Dear Sir:

In order to use this machine safely, please read this INSTRUCTION MANUAL carefully before using and installation. Heat pump water heater is a professional machine, it may cause damage or hazard when wrong installed, it should be installed by a competent person in accordance with the relevant standards for the country of use.

WARNING:

***ELECTRICAL POWER MUST BE SWITCHED OFF
BEFORE STARTING ANY WORK ON JUNCTION BOXES***

- 1. Before installing the heat pump, please ensure that the electrical supply corresponds to the specification indicated on the unit's rating label before proceeding with the connection in accordance with the wiring diagram supplied. Please check carefully on the rating label and the wiring diagrams that are pasted on each heat pump unit.**
- 2. The unit must be EARTHED to avoid any risks caused by insulation defects. It is forbidden to start any work on the electrical components without switching off the electrical supply to the unit. Electric leakage switch protection device MUST be installed.**
- 3. It is forbidden to start any work on the electrical components if water or high humidity is present on the installation site.**
- 4. When the unit is being connected, ensure that no impurities are introduced into the pipe work and the water circuits.**
- 5. All maintenance or repairmen of the heat pump must be performed by competent technicians.**
- 6. It could be hurtful when generated hot water reaches 52 °C, please mix with cold water before using.**
- 7. To prevent any damage to the fan or any accidents, it is forbidden to put your fingers or any other objects into the air outlet. Kids or children should be kept away from the heat pump.**
- 8. This appliance is not intended for use by persons (including children) with reduced physical, sensory or mental capabilities, or lack of experience and knowledge, unless they have been given supervision or instruction concerning use of the appliance by a person responsible for their safety.**
- 9. Children should be supervised to ensure that they do not play with the appliance.**

Product Introducing

⊙ **Safe and Reliable**

Unlike traditional electric water heater, heat pump water heater do not directly generate heat by electricity, it use less electricity to move heat from one place to another, electric circuit is separated from water circuit, which is also not easy for electric shock, inflammable, explosion and poisoning! Safer and more reliable!

⊙ **Highly efficient & Energy saving**

Heat pump water heater absorb plenty of heat from free ambient air, and can supply same hot water volume as electric heater. Electricity consumption is only 1/4 compared to electric heater, very energy saving!

⊙ **Environmental Friendly**

Heat pump not only use less electricity to get heat from ambient air, but are also able to combine using with solar equipment, will not cause pollution and no poison gas exhausting.

⊙ **All Round The Year Hot Water**

Heat pump water heaters are not affected by seasonal climate, provide hot water all year round even in cloudy or rainy days!

⊙ **Durable and long-lasting time**

Heat pump spare parts such as compressor and 4-way-valve are made by famous brand manufacturer, and casing panel is corrosion resistance, very durable and long-lasting time.

⊙ **Convenient Installation**

Installation site for heat pump can be the roof, the garage, the kitchen, the storing room, the basement and so on, very convenient on installation.

⊙ **Wide Application**

Heat pump water heaters are applicable for family, factory, school, hotel, hospital, and laundry, etc. Wide application for different using request.

Work principle

The low temperature and low pressure refrigerant gas come from the evaporator to the compressor, After the compressor compress it, the refrigerant gas became high temperature and high pressure. Then the gas come into the water condensation into liquid, emit a lot of condensation heat, condensing heat absorbed by water, making the water temperature increased, and then the liquid refrigerant come through the expansion valve, with a fan, the evaporator heat in the air, after all evaporation, the low pressure compressor refrigerant gas inhalation in the compressor, after working through the compressor, a high temperature and high pressure of the refrigerant gas from the compressor to exhaust emissions, such reciprocating cycle.

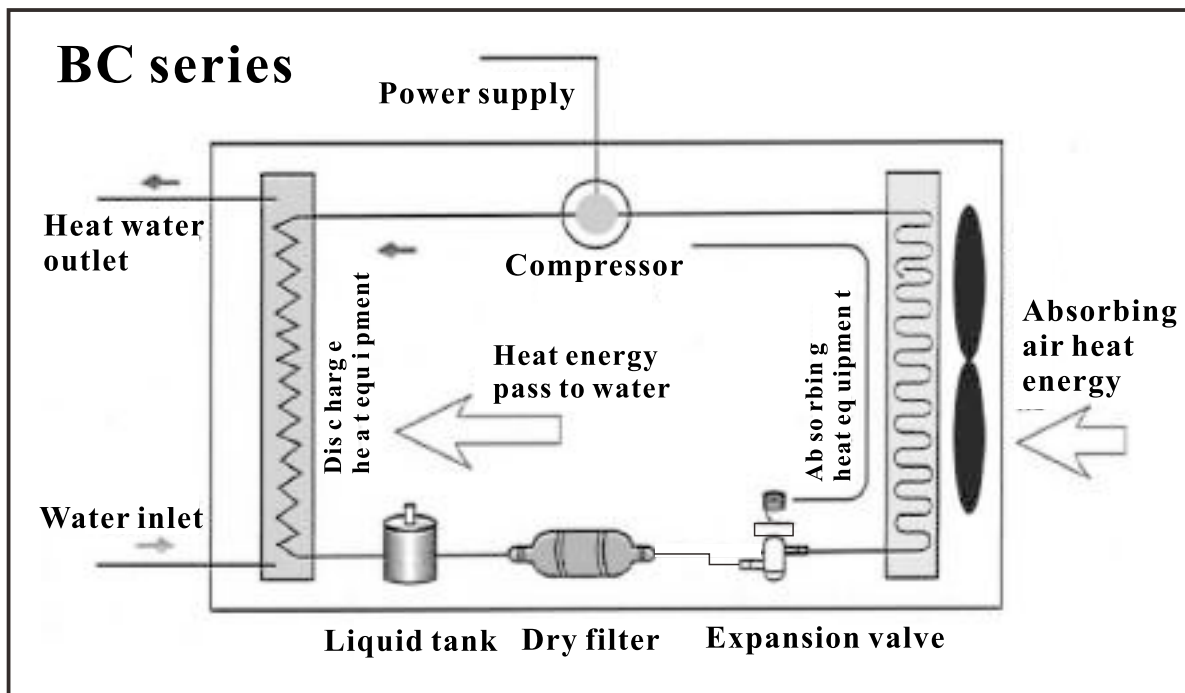

Performance Data

Air source heat pump water heater topwind series

Model	SWBC-40.0H-A-S	SWBC-45.0H-A-S	SWBC-90.0H-A-S
Rated heating capacity(w)	40000	45000	90000
Power supply(V/Ph/Hz)	380V/3PH/50HZ		
Input power(kw)	9.8	11.5	23
Running current(A)	16.0x3	18x3	36x3
Circulating unit hot water generated(L/h)	1700	1930	3840
Thermostat factory setting(°C)	55		
Thermostat maximum setting(°C)	60		
Water connections(inch)	1.5	1.5	2.0
Compressor quantity	2	2	4
Fan motor quantity	2	2	3
Fan motor input(w)	150x2	150x2	250x2
Fan speed(RPM)	890	890	890
Noise(dB(A))	62	63	65
Net dimension(mm)	1450*710*1060	1450*710*1060	2000*1100*1963
Net weight(kg)	230	248	750

Measuring conditions: dry bulb 24°C, wet bulb 19°C, water inlet 40°C, water outlet 60°C.

V. Dimension

1. The dimension for High efficiency tube in shell heat exchanger

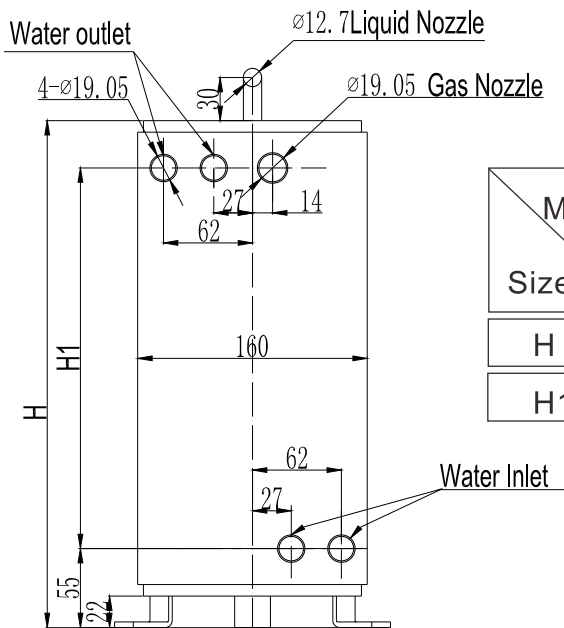

Measure: mm

Model	SWBC-40.0H-A-S	SWBC-45.0H-A-S
Size	SWBC-90.0H-A-S	
H	350	393
H1	265	308

2.The dimension for air source heat pump water heater

SWBC-40.0H-A-S,SWBC-45.0H-A-S

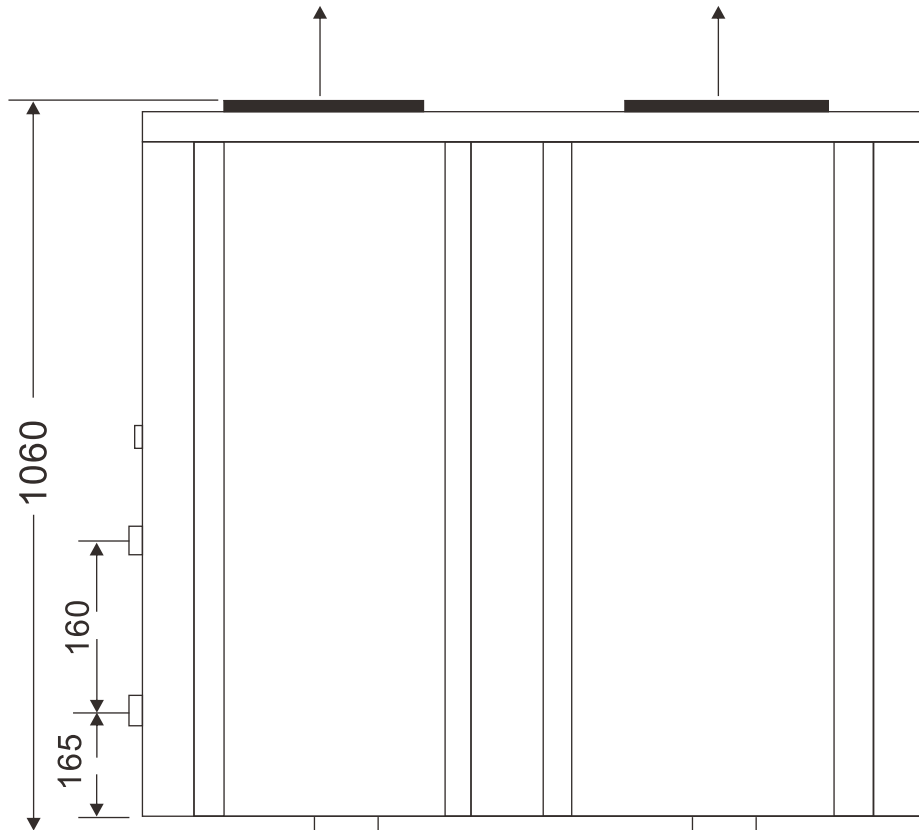
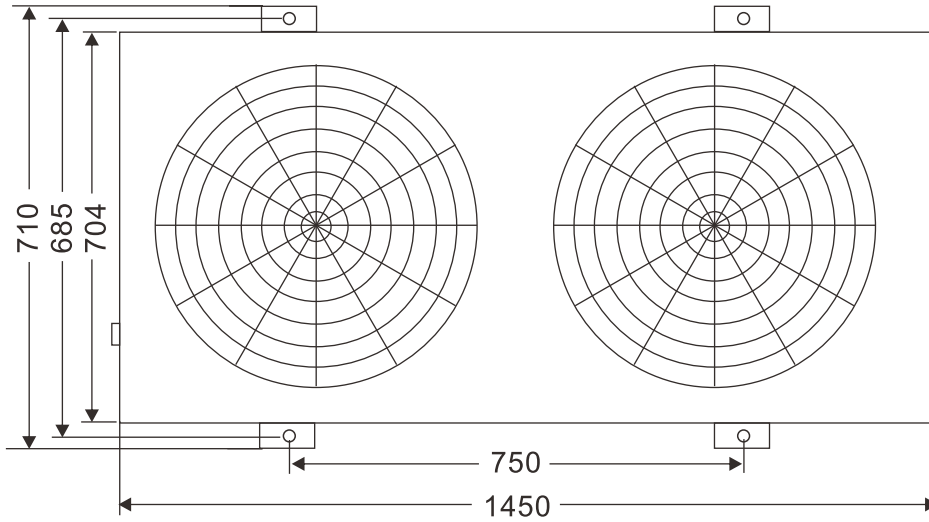

2) Casing size

Applicable model: SWBC-90.0H-A-S

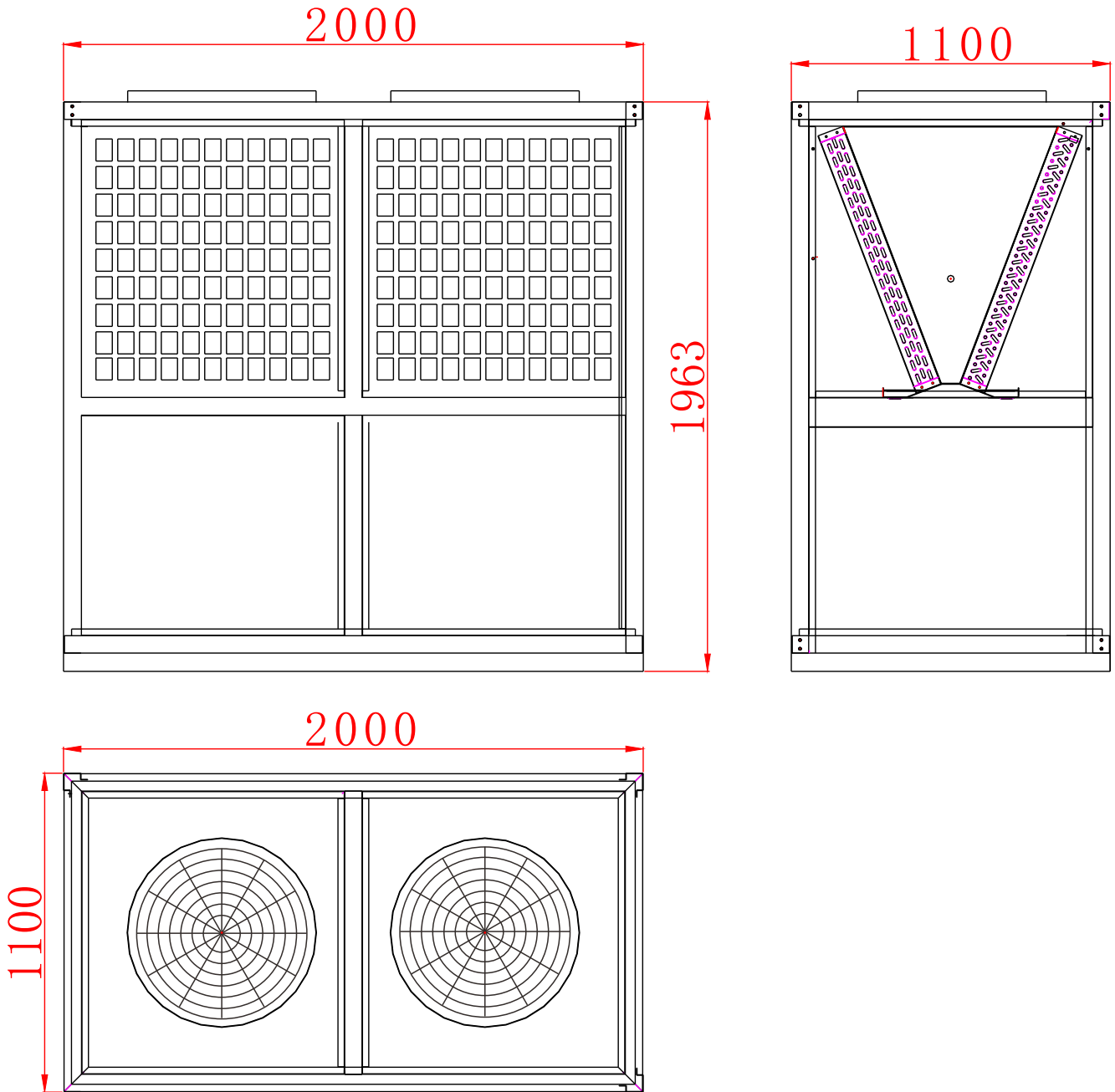

1) Controller introduction

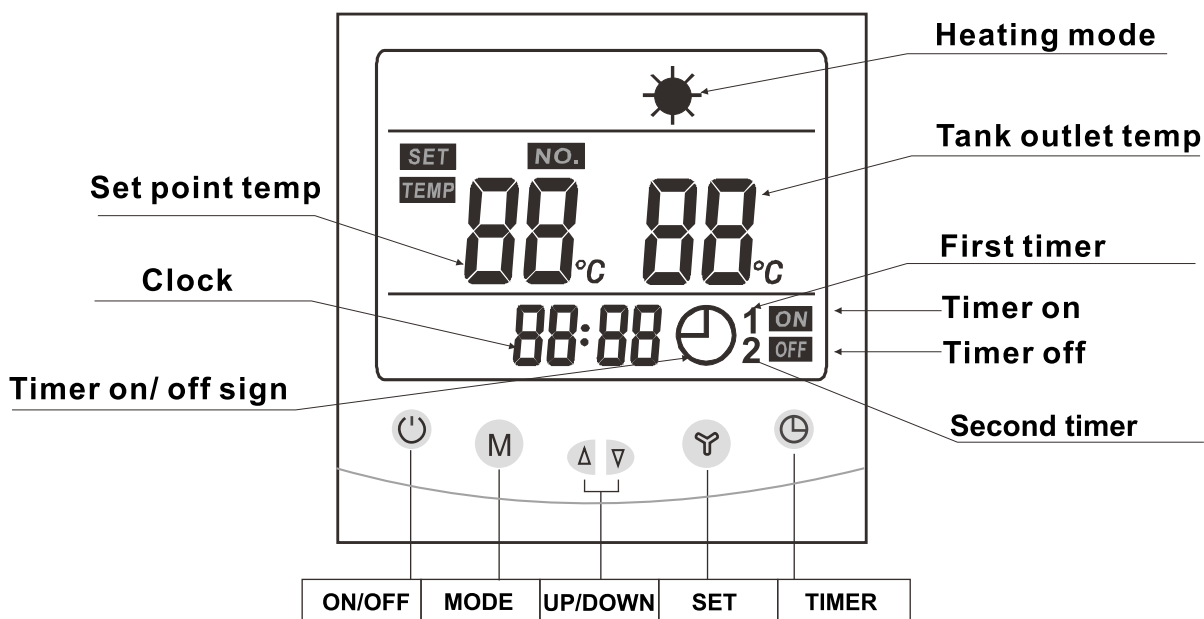

2) Wire Controller Operation

- Press button to turn on or turn off the unit.
- Press button to choose heating mode.
Long press this button for 3 seconds to enter parameter setting status inquiry.







S/N	Content	Range
0	System B coil temp sensor	0°C ~ 85°C
1	Ambient temp sensor	-30°C ~ 85°C
2	System A coil temp sensor	-30°C ~ 85°C
3	System A exhaust temp sensor	50°C ~ 120°C
4	Gas suction temp sensor	-30°C ~ 85°C
5	Electrical expansion valve running status	Actual tested value
6	Water outlet temp sensor	0°C ~ 85°C
7	System B exhaust temp sensor	50°C ~ 120°C
8	Working mode	1 heating only 0 cooling & heating

● Press  or  to directly adjust the temperature.

Press  button and  button at the same time, can turn on/off electrical heating.

Press  button and  buttons for 3 seconds, force defrosting function is on.

● Press  button once, to enter clock setting.





Under stand by/start-up state, press  button, when the place which shows hour is flashing, press  or  to adjust the hour; press  button again, when the place which shows minute is flashing, press  or  to adjust the minute, then press  button again, confirm the time setting.











When long press this button for 10 seconds, can check and adjust the parameters along with up or down buttons.















Parameters reference table

S/N	Parameters	Range	Default
	Heating set point temp	20°C -60 °C	50 °C
	Cooling set point temp	8 °C -25 °C	12 °C
0	Temp difference setting	2 °C -15 °C	5 °C
1	Water outlet temp adjustable	0°C- 10 °C	0 °C
2	Defrosting period	20min-90min	45min
3	Temp to enter defrosting	-30°C - 0 °C	-2 °C
4	Max defrosting time	3min-15min	8min
5	Temp to exit defrosting	5°C- 25 °C	15 °C
6	To exit auxiliary heating (ambient temp)	0°C- 40 °C	12 °C
7	Maximum set point temp	35°C- 65°C	60 °C
8	High pressure switch	0-1	1(yes)
9	Low pressure switch	0-1	1(yes)
a	Flow switch	0-1	1(yes)
b	Target over-heat degree	-5°C - 15 °C	5 °C
C	Second set point (maximum setting)	50°C- 60°C	60 °C
D	Second set point (minimum setting)	20°C- 40 °C	35 °C
E	System	0-1	0: single system, 1 : double system
F	Single phase/ 3 phase	0-1	0: single phase (220v) 1: three phase (380v)
H	Water pump controlling mode: 0:water pump keeps running even setting temperature is reached and heat pump in stand by mode; 1:water pump automatically turns off after compressor stops for 30 seconds.	0-1	0

- Press  to enter the setting of timer on and timer off (Totally you may set 2 difference timers on and timer off.)

Under the stand by/start-up state, press  button shows hour data and “ON” “1” flashed, press  or  to adjust the hour; press  button again, shows minute data and “ON” “1” flashed,

press  or  to adjust the minute; press  button again shows hour data and “OFF” “1” flashed, press  or  to adjust the hour; press  again shows minute data and “OFF” “1” flashed, press  or  to adjust the minute; Press  again, then the timer on and off time setting is finished. If you want to cancel this setting, press  then it will be cancelled.

At the stand by/start-up state, long press  button 3 seconds, shows hour data and “ON” “2” flashed, press  or  to adjust the hour; press  button again, shows minute data and “ON” “2” flashed, press  or  to adjust the minute; press  button again shows hour data and “OFF” “2” flashed, press  or  to adjust the hour; press  again shows minute data and “OFF” “2” flashed, press  or  to adjust the minute; Press  again, then time on and time off time setting is finished. If you want to cancel this setting, press  then it will be cancelled.

Important Note: During your setting of 2 timers(at one time) , all timer on/off setting time (00:00) shall NOT be same.

- **Setting about S1,S2 switch**

S1 Switch---Second set point

S2 Switch---Long distance demand for heating

Please refer to the wiring diagram for the location of above S1, S2 switch.

1)Heat pump turns on when S2 switch has well connected.

While S2 has connected, suddenly press the off button on the LCD controller.

Heat pump will stop for 3 minutes. However, heat pump continues to turn on if S2 still has been connected after 3 minutes.

2)The Timer function is out of validity either S2 switch has connected.

3)Heat pump turns off when S2 switch is disconnected. Meanwhile, need to use LCD controller to turn on /off the heat pump.

4)Second set point available when S1 switch has well connected.

At the same time, water temp set point setting decided by ambient temp, Parameter C and Parameter D. (Both C & D parameter could be adjusted).

Parameter C (maximum setting range 50-60 °C , default 60°C)

Parameter D (minimum setting range 20-40°C, default 35°C)

A. When ambient temp < 5°C, set point temp refer to the data of Parameter C.

B. When ambient temp >15°C, set point temp refer to the data of Parameter D.

C When < ambient temp < 15°C, set point temp = Data of Parameter C-(Data of parameter C- data of parameter D)/ (15-5)*(ambient temp -5).

For example, when ambient temp is 18 deg c, Parameter C is 50 deg c, Parameter D is 30 deg c. Then set point temp=50-(50-30)/(15-5)*(18-5)

5)When S1 disconnected, set point temp control by LCD controller.

(Refer to the setting of Parameter C & D (default setting 60° C & 35°C)

3) Malfunction data

S/N	Malfunctions	Code	Solution
1	Communication failure	E10	
2	System B coil temp sensor failure	E6	
3	Ambient temp sensor failure	P5	
4	System A coil temp sensor failure	P3	
5	System A exhaust temp sensor failure	P4	
6	Gas suction temp sensor failure	P9	
7	Tank temp sensor failure	P2	
8	System B exhaust temp sensor failure	E7	
9	Water flow switch protection	E3	
10	High pressure protection (3 times within 1 hour)	E1	
11	Low pressure protection (3times within 1 hour)	E2	
12	System A exhaust temp too high protection	P8	
13	System B exhaust temp too high protection	E8	
14	High pressure protection	E4	
15	Low pressure protection	E5	
16	Anti-Freezing protection	P7	Turn on for heating
17	Phase order failure	E9	

BC Series Water Pipe System Drawing

**Circle Type Water Heater Water Pipe System Drawing
High-efficient Heat Exchanger**

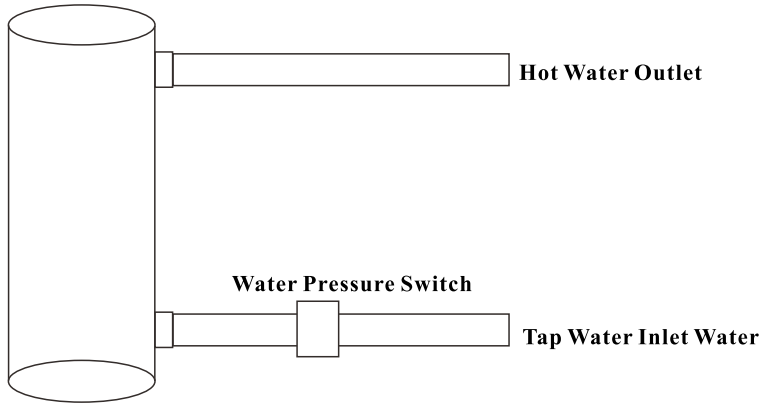

VIII. Wire Circuit Diagram

Wire Circuit Diagram

Applicable model: SWBC-40.0H-A-S SWBC-45.0H-A-S

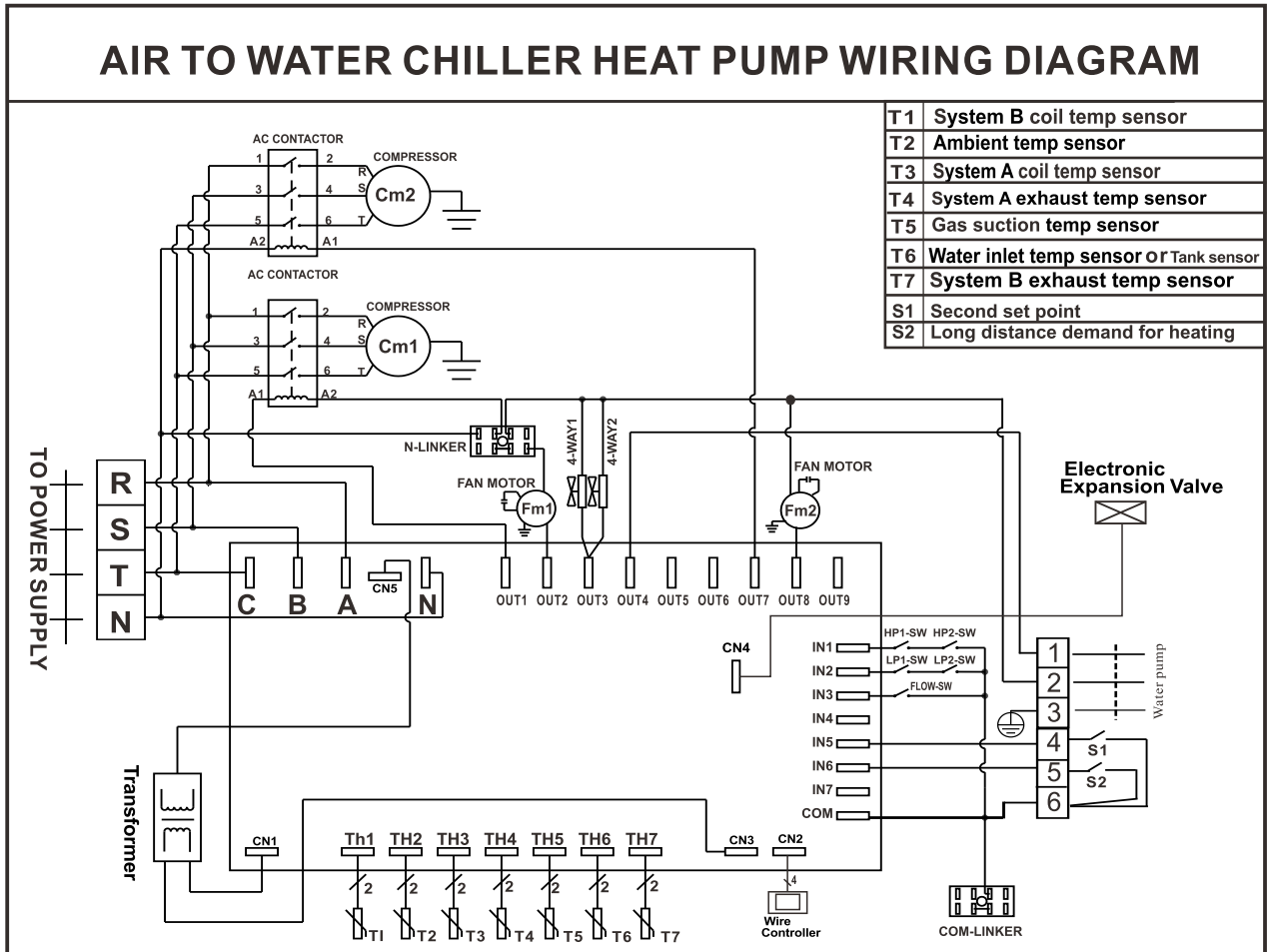

Wire Circuit Diagram

Applicable model: SWBC-90.0H-A-S

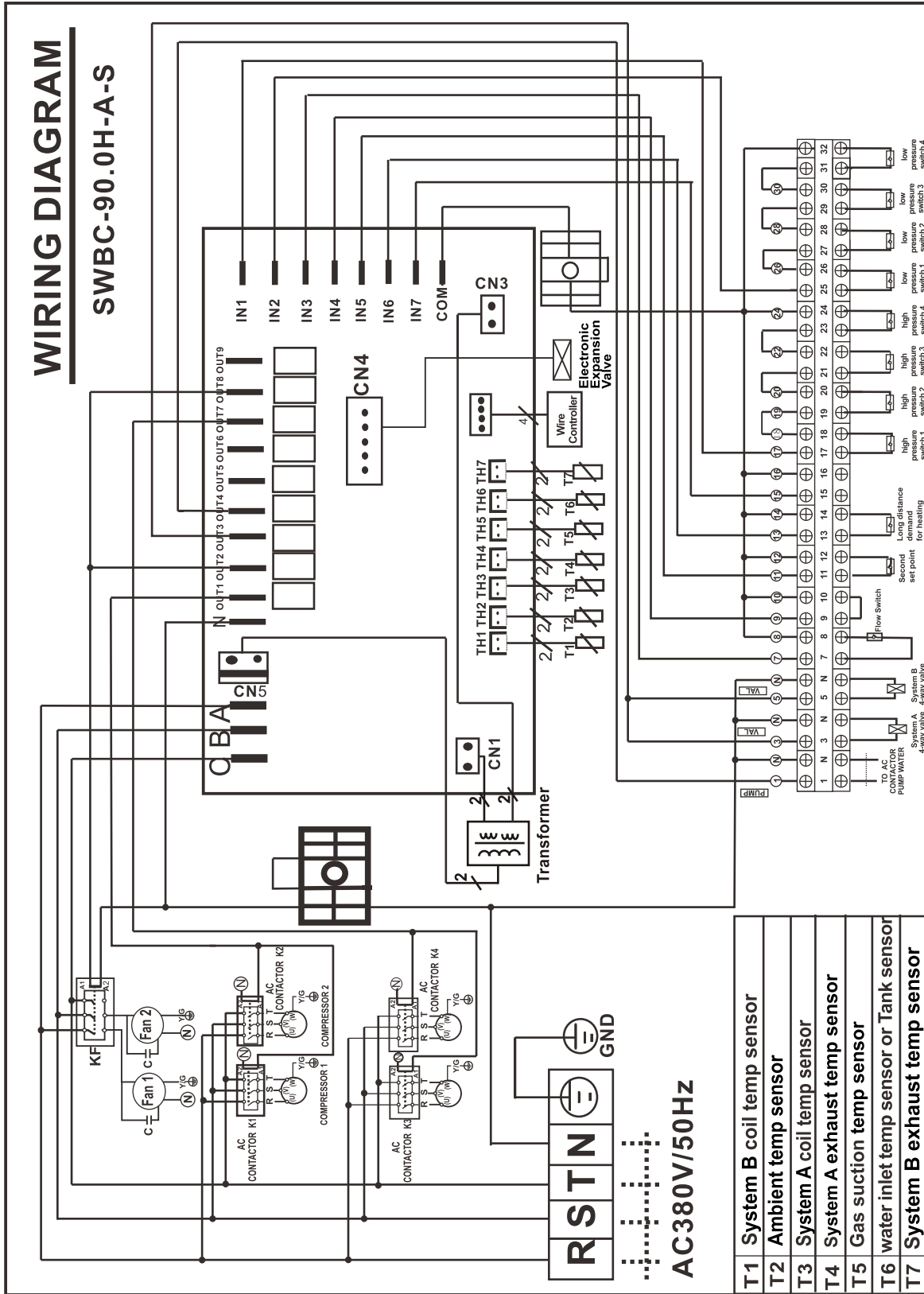

Installation instructions

1. Unit installation

1). Installation location

Host unit

- ☐ Should be installed in a larger & well-ventilated place.
- ☐ Installation location should ensure unhindered access outlet (inlet & outlet shown as below).
- ☐ Install gutter or set up positions near the outfall, to facilitate the drainage.
- ☐ The installation base or bracket should be steady, to ensure the smooth operation of running units.
- ☐ Make sure the unit is vertical after installation, and no incline.
- ☐ Make sure not to install the host unit in the any conditioner of pollution, corrosive gases, sun and fallen leaves, etc.
- ☐ Installation location must not next to place of incendive , easy-explosion and fire .
- ☐ Installation must pay attention to the distance between the barriers shown in below picture (pay attention to arrow direction).

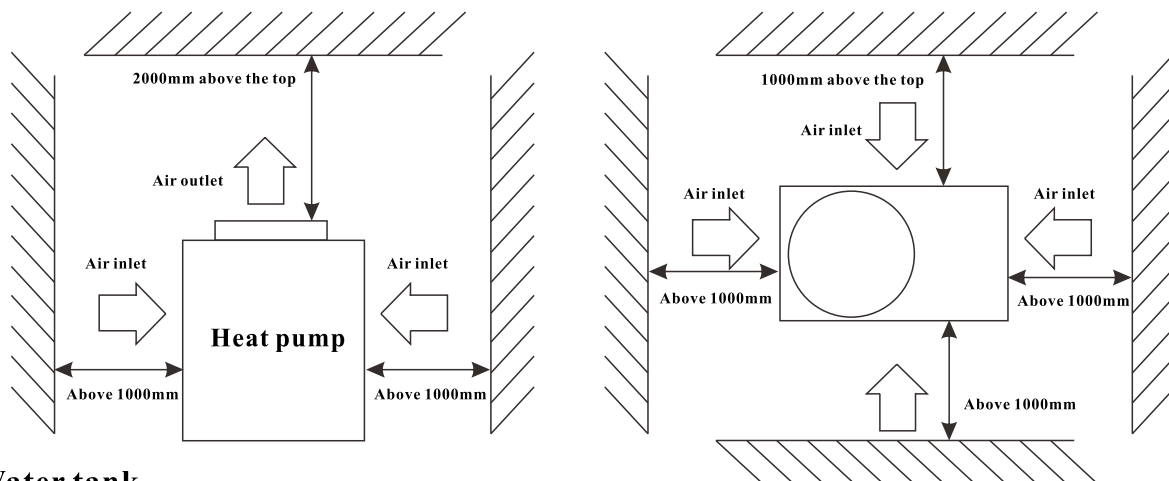

Water tank

- ☐ Water tanks should be placed where ambient temperature is above 0°C .
- ☐ Can be installed outdoors or the top of the building (based on the size of water tanks and the load-bearing capacity of the building and so on).
- ☐ Do not install water tanks in the pollution, corrosive gases place.

2). Unit installation

- ☐ Units base can be installed as cement concrete structures, steel brackets can also be used, add the shockproof rubber pads , make the base surface flat.
- ☐ Units can be designed based on the working performance.
(See Table of technical performance parameters)
- ☐ Unit should have drain or drainage inlets.
- ☐ Normally required to install in the place where setted cement concrete base.

Installation instructions

2. Pipeline connecting

Installation notes:

- ☐ Water drain pipes, overflow pipes should be installed next to the drainage inlets to facilitate drainage, vent valve should be installed on vent pipes.
- ☐ Repair valve should be installed in front of the electromagnetic valve on the pipeline system, which is convenient for future repair.
- ☐ User water pressure should less than 0.6 Mpa.
- ☐ All pipelines should choose metal pipe (such as stainless steel, with Lining Plastic and lining stainless steel and thin-walled copper pipe or, etc.). The use of plastic pipe (such as the PP-R, ABS, etc.) should consider the pipeline expansion between the host unit and water tanks.
- ☐ Water supply and pause valves may need to keep warm in the winter (according to the local winter temperature) to avoid the broken of water supply and pause valve.

Water system installation

- ☐ All the pipeline tubing should be matched as shown on the manual, and in accordance with national corresponding construction standards.
- ☐ Installation of water pipes should be straight and flat, pipeline collocation should be rational, ensure to minimize bending; reduce the resistance loss of the water system.
- ☐ Pipeline and connecting parts are not allowed a leakage phenomenon.
- ☐ After the installation of circulating pipe between tap water pipes, host unit and water tanks, should carry out water leakage testing, and eject the sewage to ensure the system's cleanness.
- ☐ If no water leakage, keep the hot water pipe warm.

3. Project example:

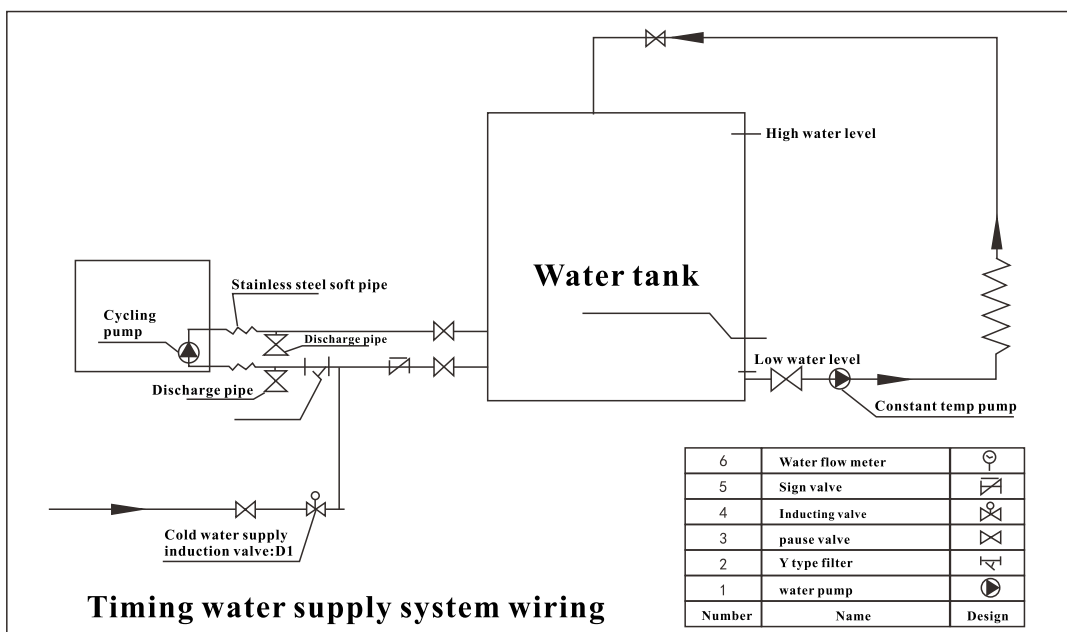

Running Test and operation**1. Preparatory work before the running test.**

a) Inspection of heat pump water heater units:

- ☐ Check if the unit appearance and the pipeline system were damaged during transport.
- ☐ Check if there is air exist in the water pipes, if yes, should empty all the air inside by the manual exhaust valve and the exhaust valve on the water pumps.
- ☐ Check if the fan rotor interference the fan fixing board and fan protection net.

b) Check the electricity distribution System

- ☐ Check if the power supply same as shown on manual and rating label.
- ☐ Check if all the power supply and control wiring are all well connected, check if the wiring is connected as wiring diagram and reliability of earth wiring.

c) Check Pipeline system

- ☐ Check the pipeline system, make sure the water supply pipes, water return pipes, pressure gauges, thermometers, valves, water flow switch are safe and correct.
- ☐ Check if having opened all the valves that should be opened, and having closed all valves that should be closed.
- ☐ Check if all necessary attemperators are good.

2. Running test

This running test must be performed by professional staff!

- ☐ Overall test can be run if the entire system inspection is conformed to regulations.
- ☐ Connected to power, start the heat pump, host unit delays three minutes then auto-start. For three-phase power supply unit, first check whether the fans and pumps' rotary direction correct or not, if not, immediately shut down the power and adjust phase sequence. Measure the compressor operation current, and if any abnormal noise. Check whether the unit conform to the requirements, run for a period of time (general 3 days), after that, the unit can be used normally.

Running Test and operation

3. Normal operation

- ☞ Heating process: start - up - water pumps runs -water flow switch inspection --- Fan operation compressor operation (when the low water level cut off, water supply induction valve opens)
- ☞ Operation Control:

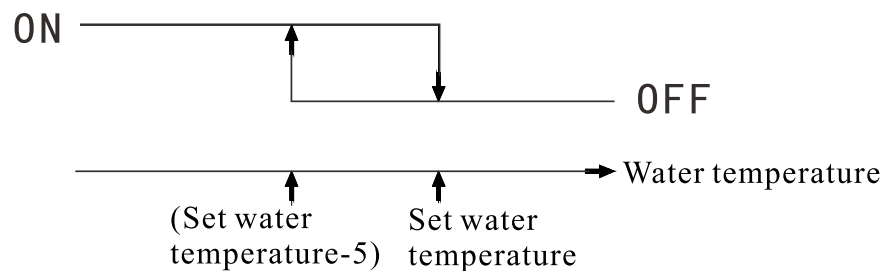

- ☞ Water level control: When the low level switch disconnect, open the water supply induction valve to supply enough water, meanwhile stop the water supply pump. Open the water supply pump when high level switch closed, After high-level switch closed for two minutes , open water supply induction valve (at least 2 minutes).
- ☞ When water pump is on and the high level switch cut off ,if water temperature $<$ (set Temperature -5 degrees) , shut down water supply for tanks, If water tank temperature $>$ (temperature -2 degrees) then open the water supply induction valve , after high-level switch closed for two minutes stop the water supply induction valve. When water pumps stopped, whatever conditions , should supply enough water. (Water supply switch on at 2 minutes).
- ☞ For the first power-on boot, the circulating water pump, compressor, fan motor runs after low level switch closed.
- ☞ During the unit operation, circulating pump open. When the unit stopped, the circulating pump will be delayed 30 seconds then stop functioning.
- ☞ When water pumps open, meanwhile open water return induction valve, 10 minutes later, test the return water temperature, when the return water temperature $>$ (water temperature -5 degrees), the return water induction valve stops. If the return water temperature $<$ (tank water temperature -10 degrees), open the water return valve so that the water supply pump constantly store the hot water. When water supply pump closed, shut down the water return valve at the same time.
- ☞ For normal start-up, the 4-way valve cut off, only when defrosting ,the unit will work in normal.

Maintenance

Heat pump water heater is a high automatic equipment, please perform regular inspection termly. If the unit can be long-term and efficiently maintenance, the operating reliability and service life will have an unexpected increase.

- 1.The extra water filters should be cleaned regularly to ensure clean water quality of the system, and to avoid damage caused by dirty water filter blocking.
- 2.Users should pay attention for usage and maintenance to below : all units' protection devices are set up before leaving factory, do not make any adjustment by yourself.
- 3.Frequently check the power supply and electrical wiring system is solid or not, whether electrical components are abnormally working, if yes, should timely maintenance and change for a new one.
- 4.Perform regular checks of the water supply system, check whether the tank safety valve, liquid level controller and exhaust devices work properly, so as to avoid air into the system, and reduce the water cycle volume, thus affect the heating function and operation reliability.
- 5.Check whether pumps and water valves are normal working or not, whether water tubing and water pipes connector are leakage or not.
- 6.The unit and around should remain clean, well-ventilated. Regularly clean (1-2 month)the side air heat exchanger to maintain a good effect of heat exchange.
- 7.Frequently check whether each part of the unit work normal or not, check whether there is oil on the pipeline joints and charging valve to ensure that no refrigerant leakage.
- 8.Do not piling up debris around the unit, so as not to block from air inlet and outlet, the unit around should be kept clean the dry, well-ventilated.
- 9.If the unit stops for a longer time, should drain all the water in the pipeline, cut off power supply, and sets the protective equipment.When re-run the unit, complete inspection is a must before reboot.
- 10.When unit failure, and the user can not resolve the problem, please call our Company in local maintenance department, in order to promptly send people for maintenance.
- 11.Host condenser cleaning.We propose to use 50°C-60°C, and 15% hot phosphoric acid for condenser cleaning, launch the circulating pump of the host unit for three hours' cleaning, finally rinse with water three times. (Propose to back up a 3-way connector when installing the pipeline, block one joint),in order to clear the connection pipe. Do not use corrosive cleaning fluid for condenser cleaning.
- 12.Water tanks need to remove theWater scale after some time (normally two months, according to the water quality of local place).

Air Source Heat Pump-Water Heater
