

AIR SOURCE HEAT PUMP WATER HEATER

Installation & Instruction Manual

Model: SWBC-90.0H-A-S

CONTENTS

I .To our customers(before installation)-----1
II .Product Introduction-----2
III .Work principle-----3
IV .Performance Data-----3
V .Dimension-----4
VI .Operation introduction-----5
VII.Electric Circuit Wiring Diagram-----17
VIII. Installation instructions-----18
IX .Maintenance-----21

Mac No. of this unit:	
------------------------------	--

Dear Sir:

In order to use this machine safely, please read this INSTRUCTION MANUAL carefully before using and installation. Heat pump water heater is a professional machine, it may cause damage or hazard when wrong installed, it should be installed by a competent person in accordance with the relevant standards for the country of use.

WARNING:

***ELECTRICAL POWER MUST BE SWITCHED OFF
BEFORE STARTING ANY WORK ON JUNCTION BOXES***

- 1. Before installing the heat pump, please ensure that the electrical supply corresponds to the specification indicated on the unit's rating label before proceeding with the connection in accordance with the wiring diagram supplied. Please check carefully on the rating label and the wiring diagrams that pasted on each heat pump unit.**
- 2. The unit must be EARTHED to avoid any risks caused by insulation defects. It is forbidden to start any work on the electrical components without switching off the electrical supply to the unit. Electric leakage switch protection device MUST be installed.**
- 3. It is forbidden to start any work on the electrical components if water or high humidity is present on the installation site.**
- 4. When the unit is being connected, ensure that no impurities are introduced into the pipe work and the water circuits.**
- 5. All maintenance or repairmen of the heat pump must be performed by competent technicians.**
- 6. It could be hurtful when generated hot water reaches 52 °C, please mix with cold water before using.**
- 7. To prevent any damage to the fan or any accidents, it is forbidden to put your fingers or any other objects into the air outlet. Kids or children should be kept away from the heat pump.**
- 8. This appliance is not intended for use by persons (including children) with reduced physical, sensory or mental capabilities, or lack of experience and knowledge, unless they have been given supervision or instruction concerning use of the appliance by a person responsible for their safety.**
- 9. Children should be supervised to ensure that they do not play with the appliance.**

Product Introduction

⊙ **Safe and Reliable**

Unlike traditional electric water heater, heat pump water heater do not directly generate heat by electricity , it use less electricity to move heat from one place to another , electric circuit is separated from water circuit ,which is also not easy for electric shock, inflammable , explosion and poisoning ! Safer and more reliable!

⊙ **Highly efficient & Energy saving**

Heat pump water heater absorb plenty of heat from free ambient air, and can supply same hot water volume as electric heater. Electricity consumption is only 1/4 compared to electric heater, very energy saving!

⊙ **Environmental Friendly**

Heat pump not only use less electricity to get heat from ambient air , but are also able to combine using with solar equipment , will not cause pollution and no poison gas exhausting .

⊙ **All Round The Year Hot Water**

Heat pump water heaters are not affected by seasonal climate, provide hot water all year round even in cloudy or rainy days!

⊙ **Durable and long-lasting time**

Heat pump spare parts such as compressor and 4-way-valve are made by famous brand manufacturer , and casing panel is corrosion resistance, very durable and long-lasting time .

⊙ **Convenient Installation**

Installation site for heat pump can be the roof, the garage , the kitchen, the storing room , the basement and so on, very convenient on installation .

⊙ **Wide Application**

Heat pump water heaters are applicable for family, factory, school, hotel , hospital , and laundry ,etc. Wide application for different using request.

Work principle

The low temperature and low pressure refrigerant gas come from the evaporate to the compressor, After the compressor compress it , the refrigerant gas became high temperature and high pressure. Then the gas come into the water condensation into liquid, emit a lot of condensation heat, condensing heat absorbed by water, making the water temperature increased, and then the liquid refrigerant come through the expansion valve, with a fan , the evaporate heat in the air, after all evaporation , the low pressure compressor refrigerant gas inhalation in the compressor, after working through the compressor, a high temperature and high pressure of the refrigerant gas from the compressor to exhaust emissions, such reciprocating cycle.

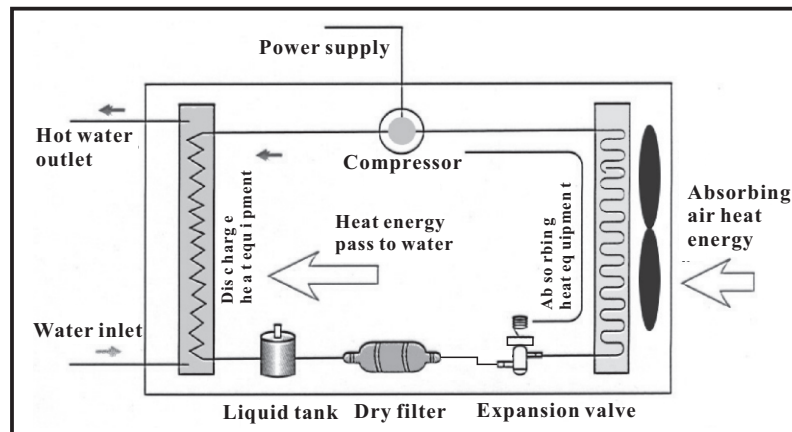

IV .Performance Data

Performance Data

Model	SWBC-90. 0H-A-S
Rated heating capacity(w)	90000
Power supply(V/Ph/Hz)	380V/3PH/50HZ
Heating input power(kw)	23. 0
COP	3. 9
Running current heating(A)	36. 0*3
Rated cooling capacity(w)	84000
Cooling input power(kw)	28. 0
Running current cooling(A)	43. 4*3
EER	3. 0
Circulating unit hot water generated(L/h)	3840
Heating range(°C)	25~60
Cooling range(°C)	10~25
Water connections(inch)	2. 0
Compressor quantity	4
Fan motor quantity	2
Fan motor input(w)	780*2
Fan speed(RPM)	1410
Noise[dB(A)]	65
Net dimension(mm)	2000*1100*1963
Net weight(kg)	650

Measuring conditions:Heating:dry bulb 7°C,wet bulb 6°C, water inlet 30°C,water outlet 35°C ;
Cooling:dry bulb 35°C,wet bulb 24°C, water inlet 12°C,water outlet 7°C .

1. The dimension for air source heat pump water heater

SWBC-90.0H-A-S

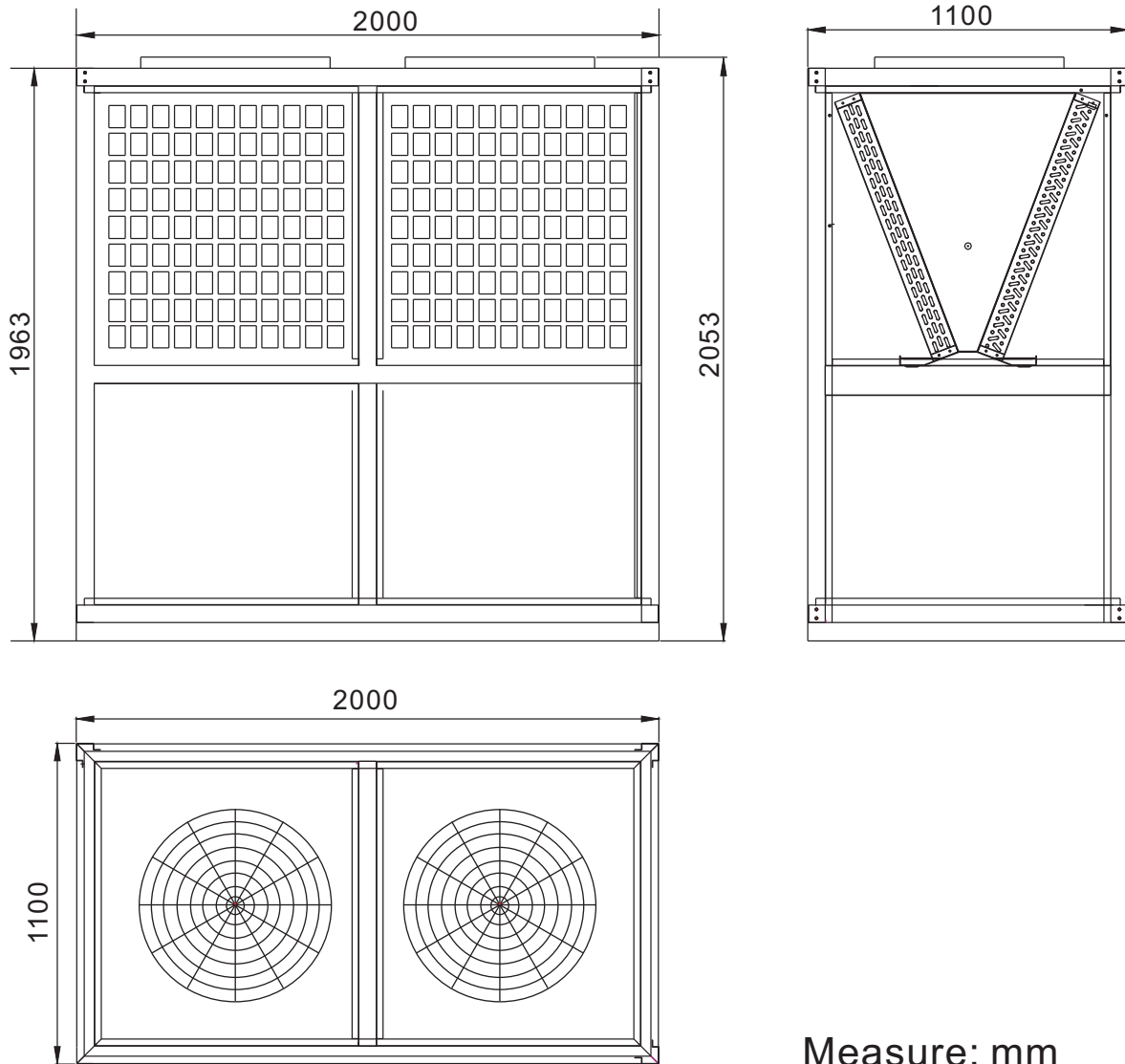

Measure: mm

2. The dimension for High efficiency tube in shell heat exchanger

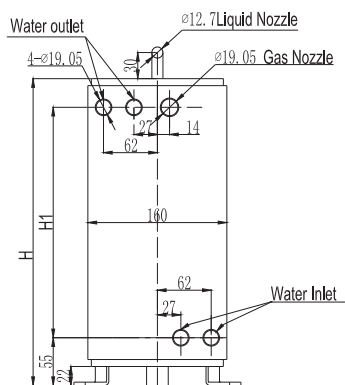

Measure: mm







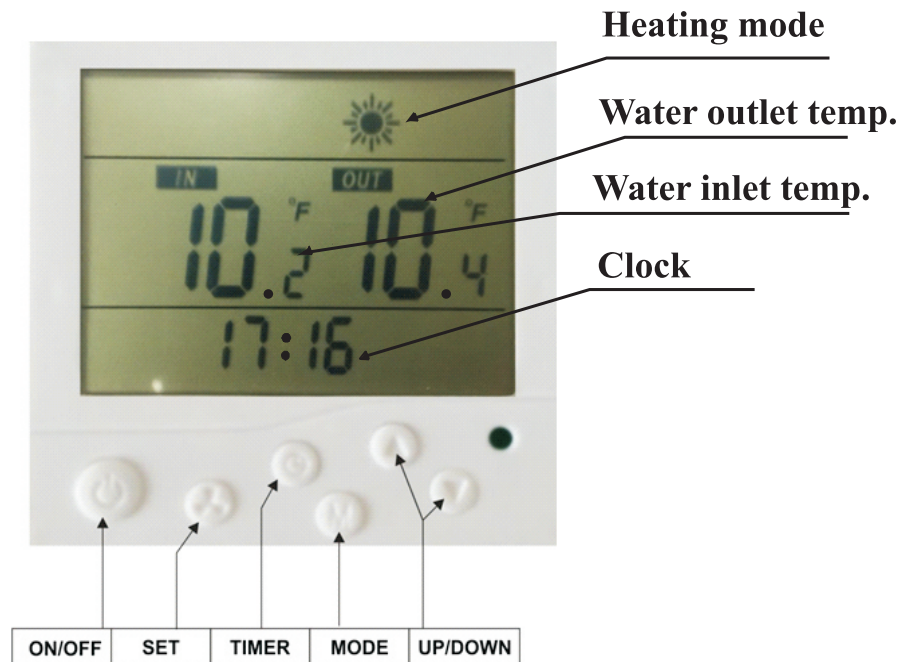







Model	SWBC-90.0H-A-S
Size	
H	350
H1	265

Operation introduction

1). Controller introduction



2) Wire controller button definition

-  button
---to turn on or turn off your heat pump.
-  and  button
-----up and down button to check or change setting.
Press these two button at the same time for 3seconds, lock the keyboard.
-  button
Press  button alone, could come to clock setting. First set the hour data, and use  or  button to change the hour data.
Secondly press  again, to come to minute data setting. Still use  or  button to change the minuted data. After that, press  to confirm.
-  button
---Press  for 3 seconds in standby status, could enter for Force Defrost.
-  button
----Button for timming.Integrating with up and down button, to set the time for turning on or turning off the heat pump.

Operation introduction

- ◎ In the state of OFF, LCD display clock and working mode only.

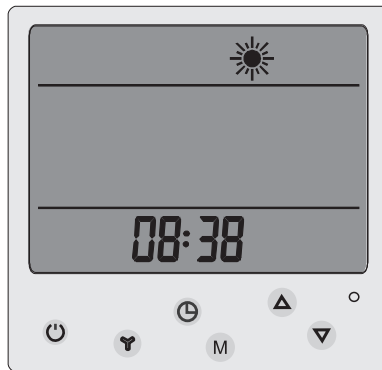



- ◎ When Press “power” button, heat pump turn on, and LCD display as below.



Parameter data setting

You could check and change the setting from any status as below steps.

1. Press up/ down button for the parameter you want to change setting.
2. When the **SET** appearing on the screen ,means you can change the data.
2. Press  button once, and the right data flash
3. Use up/down button to change the setting.
4. Press  button again for confirm.



◎ **Real Time Clock Setting**

In the default state, press "☺" once to enter Real Time Clock Setting State; In the state of Real Time Clock Setting, press "☺" once again, hour numbers flash, press "▲" or "▼", can adjust the hour for the clock.

After the clock hour is setted, press "☺" once again, minute numbers flash, press "▲" or "▼", can adjust the minute for the clock. After setting the clock minute, press "☺" again to confirm the clock setting and return default state.



◎ **Timming ON /OFF Setting**

In default state, press "⌚" once to enter Timming Setting state. press "⌚" again, the hour numbers for timming ON flash, press "▲" or "▼" to adjust the hour for timming ON setting.

After setting the hour for timming ON, press "⌚" once again, the minute number for timming ON flash, press "▲" or "▼" to adjust the minute for timming ON.

After setting the minute for timming ON, press "⌚" once again, to enter the hour setting of timming OFF;

After setting the timming OFF hour and minute, press "⌚" again, to confirm current setting and return to default state.

In the state of Timming Setting, press "⌚" once again, when the timming ON /OFF setting is set at the same time, the timming ON/OFF setting is cancelled.

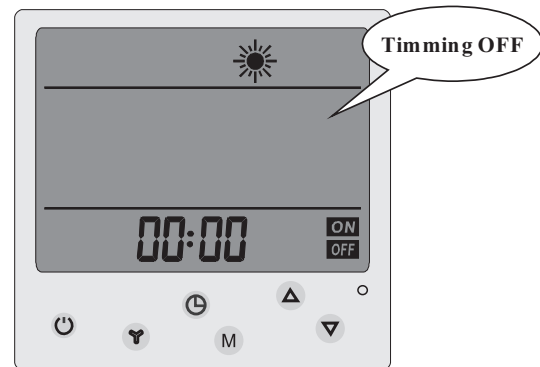
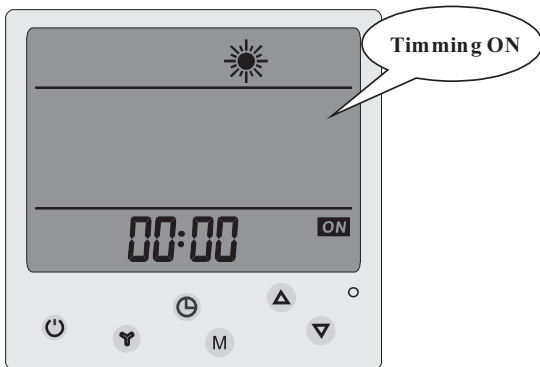

◎ **Back Up Memory After Power Resumption**

When the heat pump is working in normal state and electricity power cut off suddently, the system will run in the last setting record after power resumption.

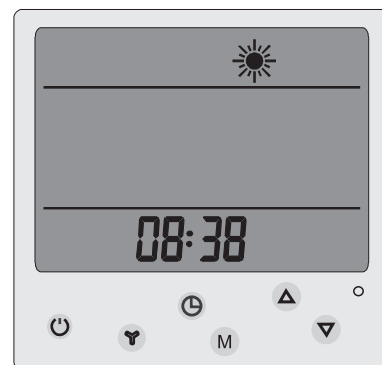

4. Parameters

Digit	Meaning	Range	Default	Remarks
SET0	Cold water set point temp	10-25°C	12°C	Can adjust
SET1	Hot water set point temp	25-60°C	55°C	Can adjust
1	Water inlet temp	0~99°C		Tested data
2	Water outlet temp	0~99°C		Tested data
3	Coil temp of system 1	-35~80°C		Tested data
4	Coil temp of system 2	-35~80°C		Tested data
5	Air circulation temp 1	-35~80°C		Reserve
6	Air circulation temp 2	-35~80°C		Reserve
7	Ambient temp	-35~80°C		Tested data
8	Exhaust temp of system 1	0~125°C		Tested data
9	Exhaust temp of system 2	0~125°C		Tested data
10	Actual steps for EEV	100~470		Tested data
11	Tank water temp	0~99°C		Reserve

Operation introduction

5 Failure code and parameter tables

Protect/Failure	Long-distance controller	Remark
Water inlet temperature sensor failure	PP 1	
Water outlet temperature sensor failure	PP2	
Coil temperature sensor 1 failure	PP3	
Air circulation temperature sensor 1 failure	PP4	
Ambient temperature sensor failure	PP5	
Coil temperature sensor 2 failure	PP6	
Winter anti-freezing protection I	PP7	
Winter anti-freezing protection II	PP7	
Air circulation temperature sensor 2 failure	PP8	
Exhaust temperature sensor 1 failure	PP9	
Exhaust temperature sensor 2 failure	PP10	
Exhaust 1 high temperature protection	PP 11	
Exhaust 2 high temperature protection	PP 12	
Water-in and water-out temp difference protection	PP 13	
Anti freezing under cooling mode	PP 14	
System high pressure protection	EE 1	
System low pressure protection	EE 2	
Water flow switch failure	EE 3	
Power source wrong/open phase	EE 4	
Water-in and water-out temp difference too much shut down protection	EE 5	
Wire controller communication failure	EE 8	
Defrosting		

6. Two ways to connect wifi

a. First way

● For Android System

- Install the APP of “SmartLink3 Demo”
- Turn on the heat pump, and make sure the area of heat pump installed cover with wifi signal. What's more, make sure your smart phone with wifi connected.
- Long press the ON/OFF button and DOWN button of LCD controller for 10 seconds. See below pic.

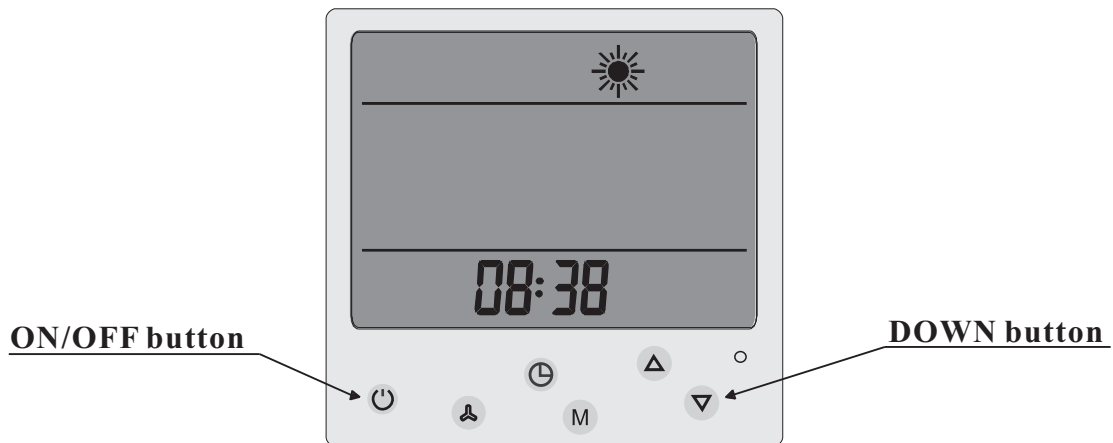

- Then input the password for example 12345678 of WIFI TP LINK-22233. **(The wifi should be your local wifi, and your password of local wifi)** And press “Start”, see below pic. (Your smart phone should near the controller to ensure easy connected for wifi)

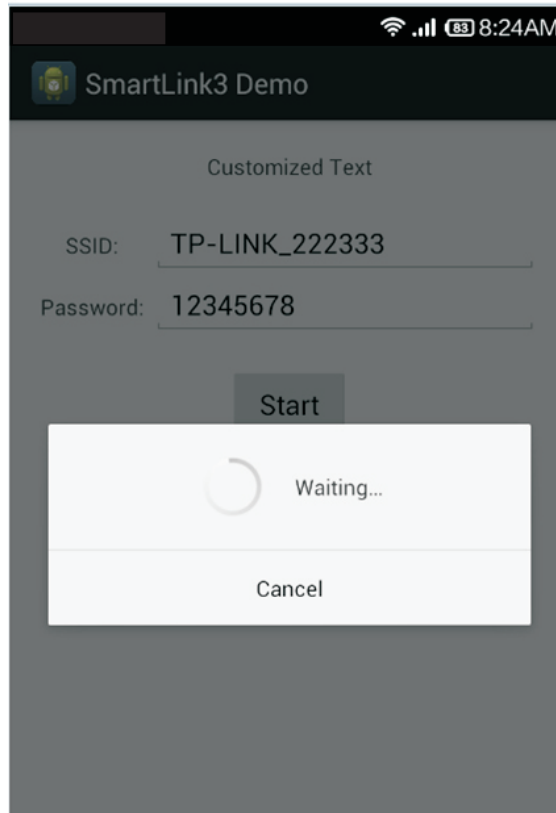

a. First way

- It may take 1 minute to match all wifi setting.

If connected successful, it could show “SmartLink Compelcted” as below pic.

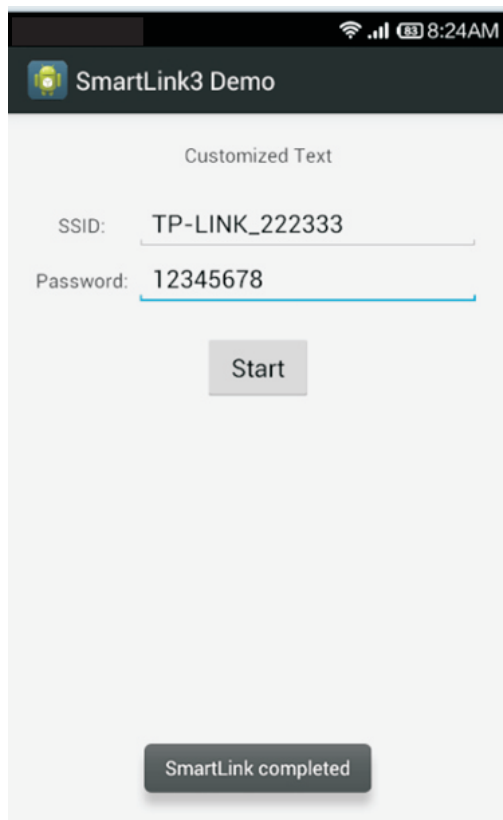

- If failed, it could show “time out” as below pic, then you have to repeat step 3 & 4 again.

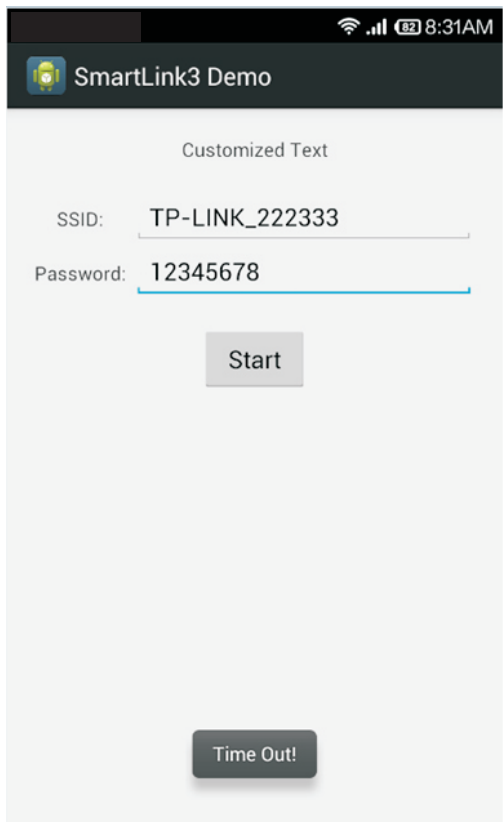

a. First way**● For IOS System**

- Find out “SmartLink” in the APP Store, download and install it.

You can scan below QR code for fast installation as well.

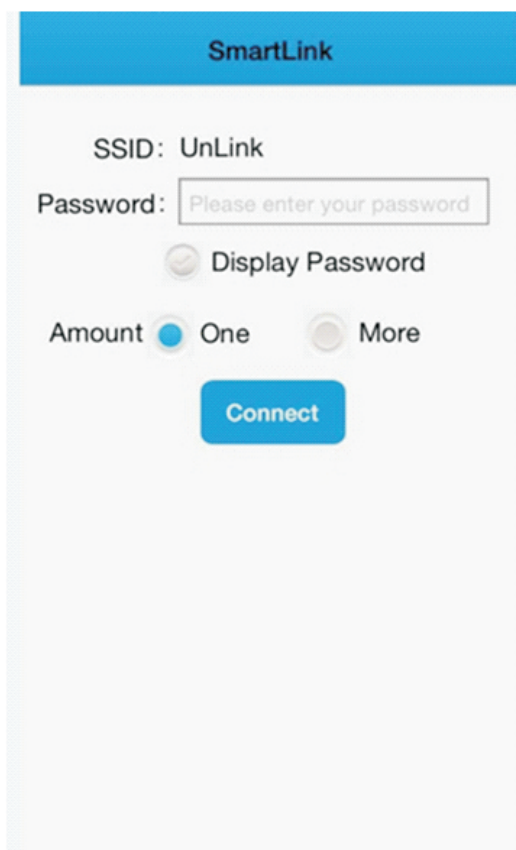

- Input the passwords of your local wifi.

A screenshot of the SmartLink app's WiFi connection screen. The title bar is blue with the text "SmartLink". Below it, the SSID is "UnLink". There is a "Password:" label followed by a text input field containing the placeholder "Please enter your password". Below the input field is a "Display Password" option with a radio button. At the bottom, there are two radio buttons for "Amount": "One" (selected) and "More". A blue "Connect" button is centered at the bottom.

- Other setting please refer to Android system, as they are the same.

Remarks, initial wifi setting may need a few times to complete. Please try more times if once is not successful.

b. Second way for wifi setting

- Turn on the heat pump.
- Use laptop or smart phone to find wifi “HF-LPB100” and connect it.
- Open website of “10.10.100.254”, input user name and password as below.

User name: admin Password: admin

After that, you could find below interface.



- Select work mode, change to STA mode. And then press Save. See below ref pic.



b. Second way for wifi setting

- Then select STA setting, press Scan, then press Save. See below refer pic.



- Please choose the safety and reliable local area network which available. Then press OK to Confirm.

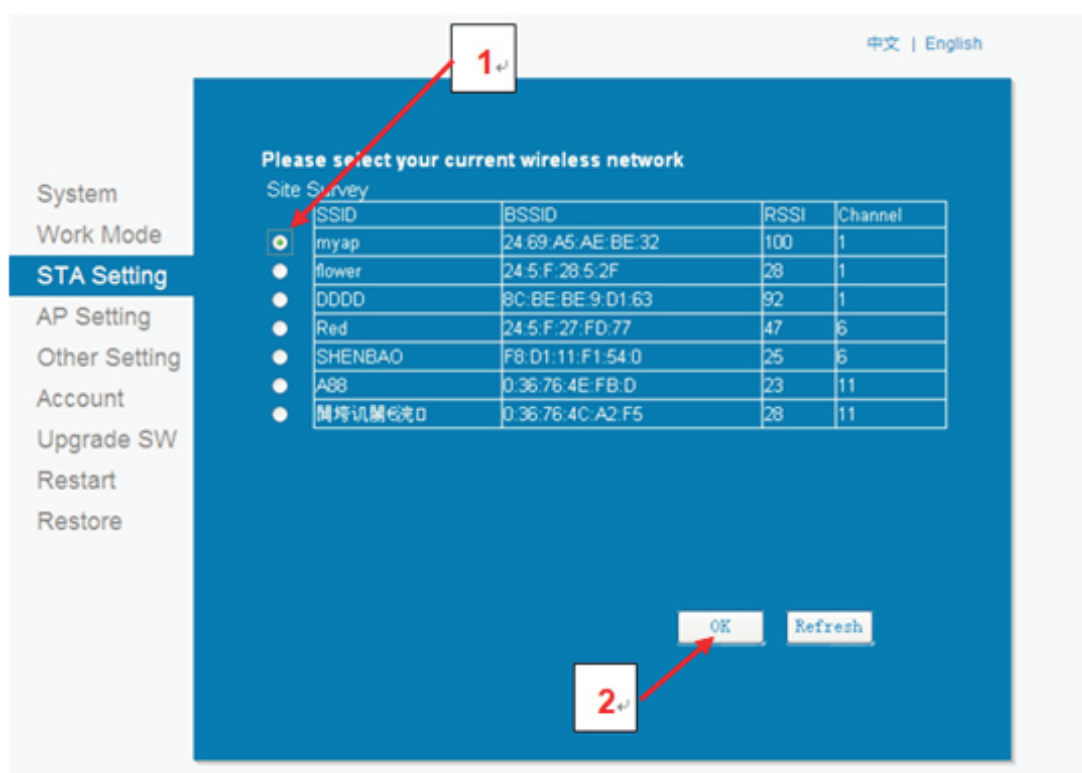

b. Second way for wifi setting

- Make sure the Encryption Method choose **WPA2PSK**, and Encryption Algorithm choose **AES**. Input the **password** of your local area network. Then press **Save**.



- After finished all above steps, come to Restart interface, and press OK to confirm RESTART. See below pic.

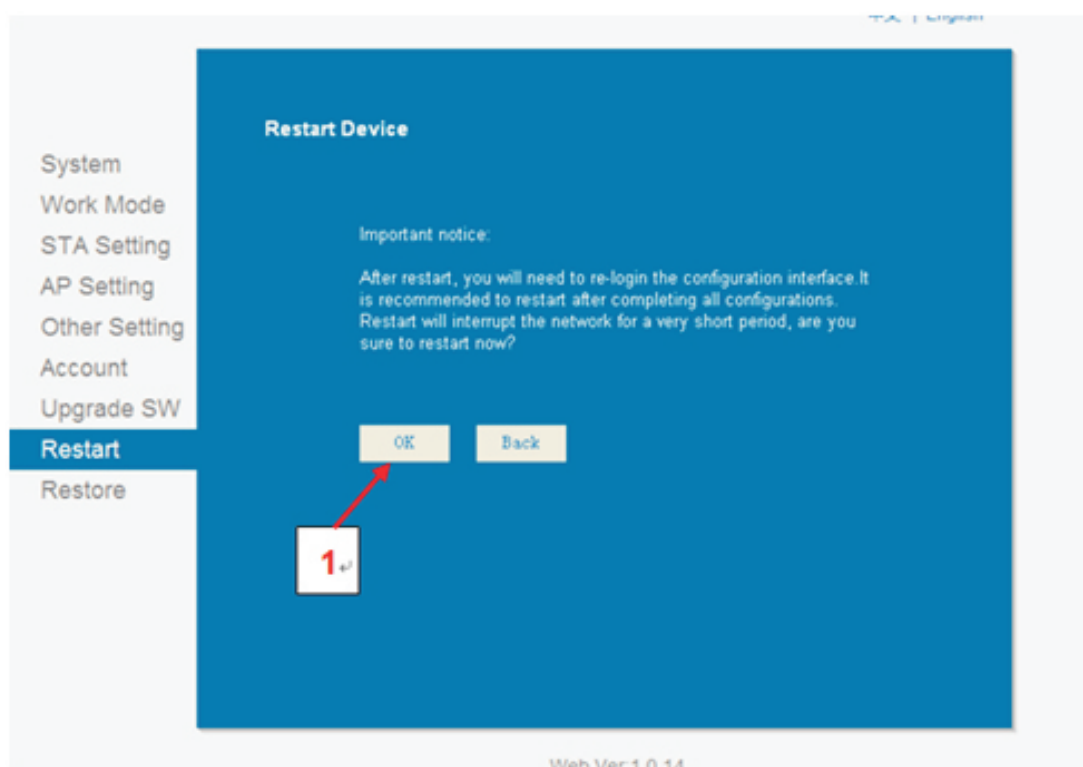

c. Remarks

- Make sure to press “SAVE” for each setting.
- If IP address changed, all above setting need to re-set.
- If you try first way of “Smartlink3 DEMO” and failed, then try the second way for wifi setting.
- Long press turn ON/OFF button and UP button for 10 seconds ,wifi will restore the default state.(see below pic)

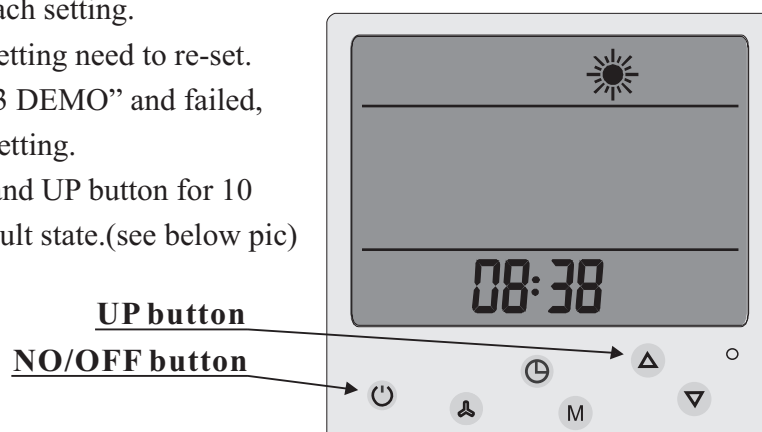
**d. Fast Inquiry**

- After wifi connected successful, you could have inquire about heat pump status by below website. <http://app.xlink.cn:9001/query.html>
Or you could scan below QR Code to enter the website for Heat pump status checking.
Fast inquire (only to check 1 or 2 heat pump units)



- Agent research (Able to check all the heat pumps as order). Or visit below website.
<http://app.xlink.cn:9001/login.html>



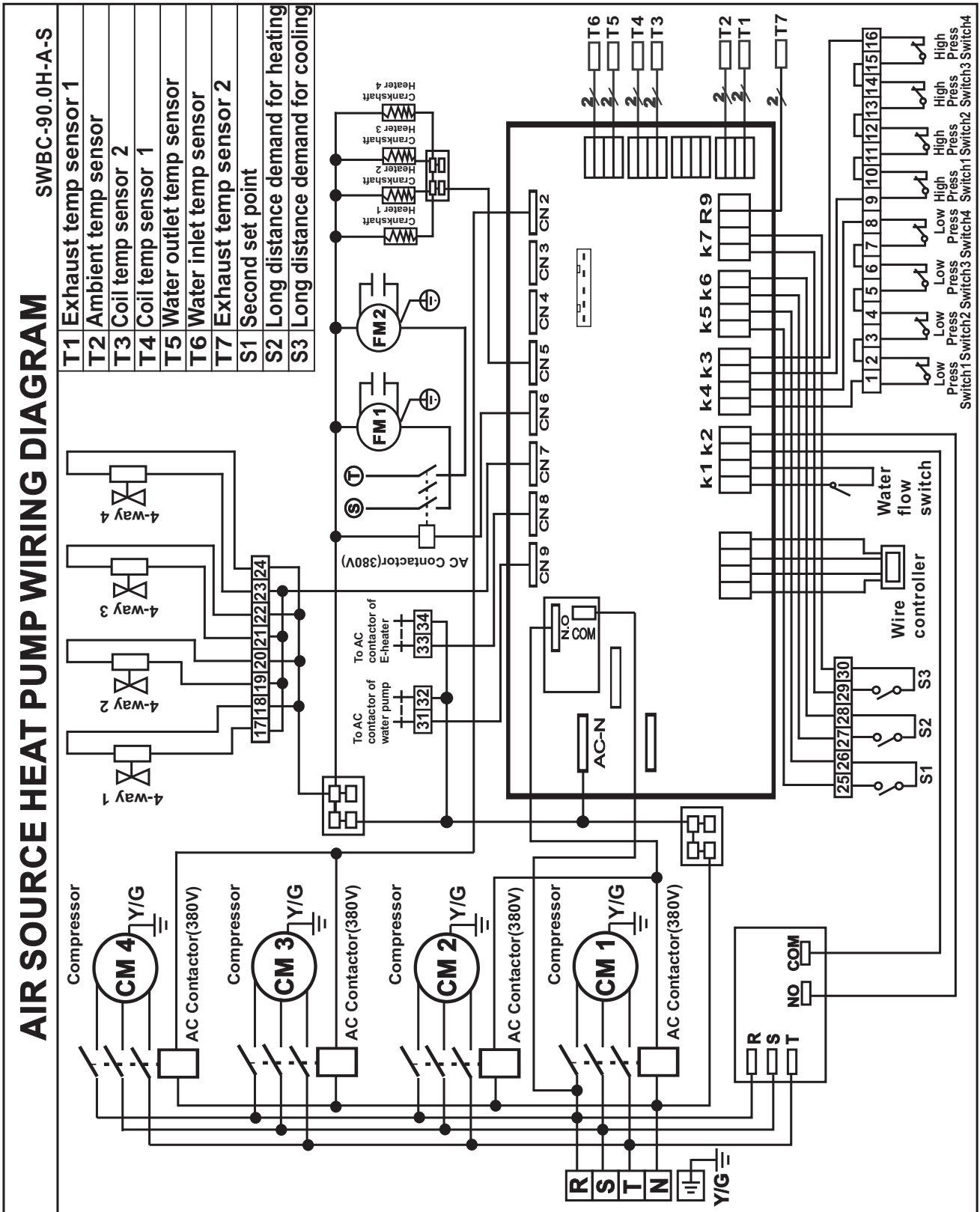

VIII. Installation instructions

1. Unit installation

1). Installation location

Host unit

- ☞ Should be installed in a larger & well-ventilated place.
- ☞ Installation location should ensure unhindered access outlet (inlet & outlet shown as below).
- ☞ Install gutter or set up positions near the outfall, to facilitate the drainage.
- ☞ The installation base or bracket should be steady, to ensure the smooth operation of running units.
- ☞ Make sure the unit is vertical after installation, and no incline.
- ☞ Make sure not to install the host unit in the any conditioner of pollution, corrosive gases, sun and fallen leaves, etc.
- ☞ Installation location must not next to place of incensive , easy-explosion and fire .
- ☞ Installation must pay attention to the distance between the barriers shown in below picture (pay attention to arrow direction).

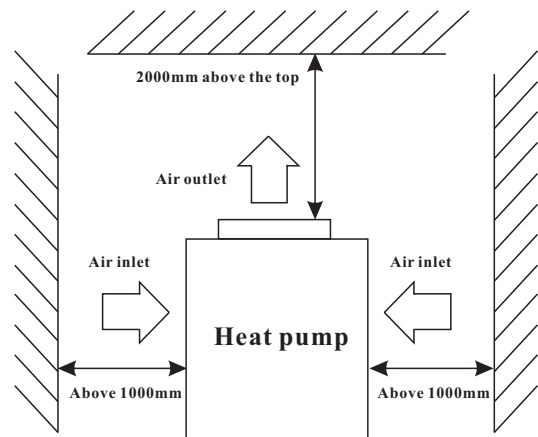

Water tank

- ☞ Water tanks should be placed where ambient temperature is above 0°C .
- ☞ Can be installed outdoors or the top of the building (based on the size of water tanks and the load-bearing capacity of the building and so on).
- ☞ Do not install water tanks in the pollution, corrosive gases place.

2). Unit installation

- ☞ Units base can be installed as cement concrete structures, steel brackets can also be used, add the shockproof rubber pads , make the base surface flat.
- ☞ Units can be designed based on the working performance.
(See Table of technical performance parameters)
- ☞ Unit should have drain or drainage inlets.

Normally required to install in the place where setted cement concrete base.

2. Pipeline connecting

Installation notes:

- ☞ Water drain pipes, overflow pipes should be installed next to the drainage inlets to facilitate drainage, vent valve should be installed on vent pipes.
- ☞ Repair valve should be installed in front of the electromagnetic valve on the pipeline system, which is convenient for future repair.
- ☞ User water pressure should less than 0. 6 Mpa.
- ☞ All pipelines should choose metal pipe (such as stainless steel, with Lining Plastic and lining stainless steel and thin-walled copper pipe or, etc.). The use of plastic pipe (such as the PP-R, ABS, etc.) should consider the pipeline expansion between the host unit and water tanks .
- ☞ Water supply and pause valves may need to keep warm in the winter (according to the local winter temperature) to avoid the broken of water supply and pause valve.

Water system installation

- ☞ All the pipeline tubing should be matched as shown on the manual, and in accordance with national corresponding construction standards.
- ☞ Installation of water pipes should be straight and flat, pipeline collocation should be rational, ensure to minimize bending; reduce the resistance loss of the water system.
- ☞ Pipeline and connecting parts are not allowed a leakage phenomenon.
- ☞ After the installation of circulating pipe between tap water pipes, host unit and water tanks , should carry out water leakage testing, and eject the sewage to ensure the sy stem's cleanness.
- ☞ If no water leakage, keep the hot water pipe warm.

3. Project example:

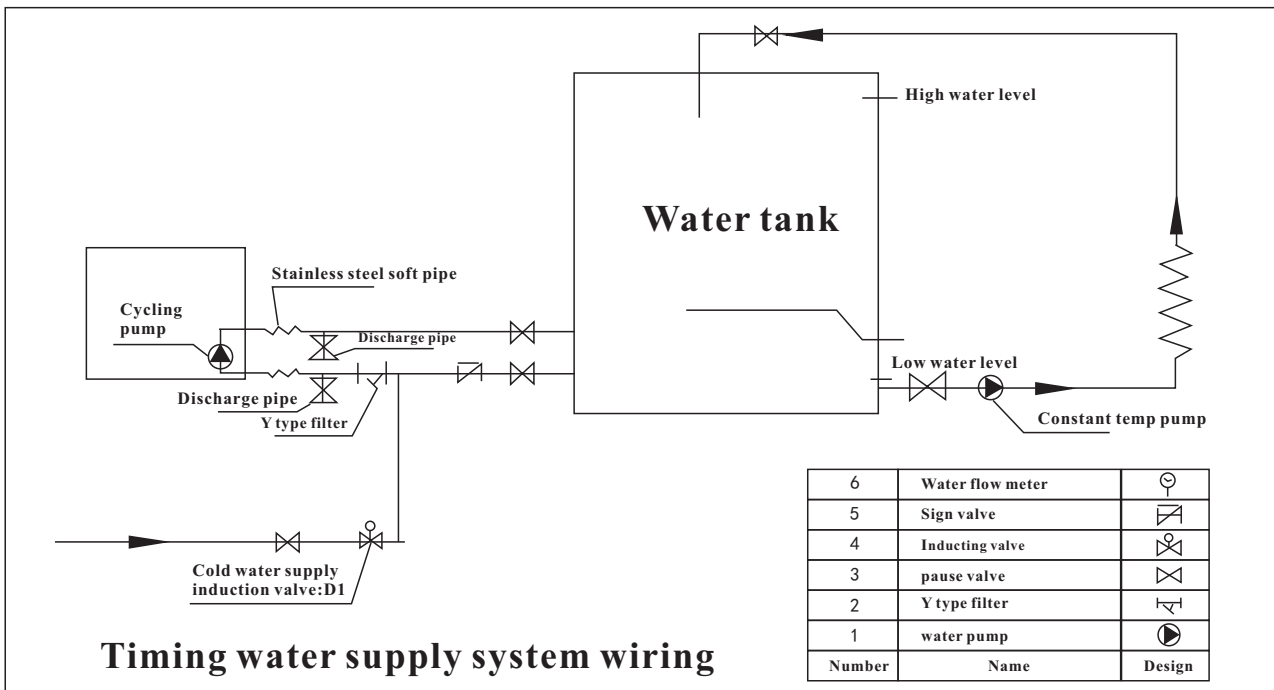

Running Test and operation

1. Preparatory work before the running test.

a) Inspection of heat pump water heater units:

- ☞ Check if the unit appearance and the pipeline system were damaged during transport.
- ☞ Check if there is air exist in the water pipes, if yes, should empty all the air inside by the manual exhaust valve and the exhaust valve on the water pumps.
- ☞ Check if the fan rotor interference the fan fixing board and fan protection net.

b) Check the electricity distribution System

- ☞ Check if the power supply same as shown on manual and rating label.
- ☞ Check if all the power supply and control wiring are all well connected, check if the wiring is connected as wiring diagram and reliability of earth wiring.

c) Check Pipeline system

- ☞ Check the pipeline system, make sure the water supply pipes, water return pipes, pressure gauges, thermometers, valves, water flow switch are safe and correct.
- ☞ Check if having opened all the valves that should be opened, and having closed all valves that should be closed.
- ☞ Check if all necessary attemperators are good.

2. Running test

This running test must be performed by professional staff!

- ☞ Overall test can be run if the entire system inspection is conformed to regulations.
- ☞ Connected to power, start the heat pump, host unit delays three minutes then auto-start. For three-phase power supply unit, first check whether the fans and pumps' rotary direction correct or not, if not, immediately shut down the power and adjust phase sequence. Measure the compressor operation current, and if any abnormal noise. Check whether the unit conform to the requirements, run for a period of time (general 3 days), after that, the unit can be used normally.

3. Normal operation

- ☞ Heating process: start - up - water pumps runs -water flow switch inspection --- Fan operation compressor operation (when the low water level cut off, water supply induction valve opens

- ☞ Operation Control:

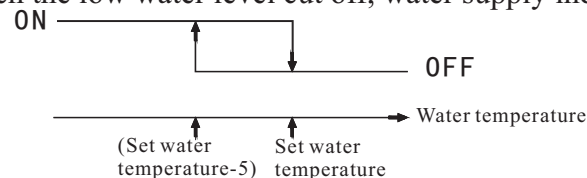

- ☞ Water level control: When the low level switch disconnect, open the water supply induction valve to supply enough water, meanwhile stop the water supply pump. Open the water supply pump when high level switch closed, After high-level switch closed for two minutes, open water supply induction valve (at least 2 minutes).
- ☞ When water pump is on and the high level switch cut off, if water temperature $<(\text{set Temperature} - 5 \text{ degrees})$, shut down water supply for tanks, If water tank temperature $>(\text{temperature} - 2 \text{ degrees})$ then open the water supply induction valve, after high-level switch closed for two minutes stop the water supply induction valve. When water pumps stopped, whatever conditions, should supply enough water. (Water supply switch on at 2 minutes).
- ☞ For the first power-on boot, the circulating water pump, compressor, fan motor runs after low level switch closed.
- ☞ During the unit operation, circulating pump open. When the unit stopped, the circulating pump will be delayed 30 seconds then stop functioning.
- ☞ When water pumps open, meanwhile open water return induction valve, 10 minutes later, test the return water temperature, when the return water temperature $>(\text{water temperature} - 5 \text{ degrees})$, the return water induction valve stops. If the return water temperature $<(\text{tank water temperature} - 10 \text{ degrees})$, open the water return valve so that the water supply pump constantly store the hot water. When water supply pump closed, shut down the water return valve at the same time.
- ☞ For normal start-up, the 4-way valve cut off, only when defrosting, the unit will work in normal.

Maintenance

Heat pump water heater is a high automatic equipment, please perform regular inspection termly. If the unit can be long-term and efficiently maintenance, the operating reliability and service life will have an unexpected increase.

- 1.The extra water filters should be cleaned regularly to ensure clean water quality of the system, and to avoid damage caused by dirty water filter blocking.
- 2.Users should pay attention for usage and maintenance to below : all units' protection devices are set up before leaving factory, do not make any adjustment by yourself.
- 3.Frequently check the power supply and electrical wiring system is solid or not, whether electrical components are abnormally working, if yes, should timely maintenance and change for a new one.
- 4.Perform regular checks of the water supply system, check whether the tank safety valve, liquid level controller and exhaust devices work properly, so as to avoid air into the system, and reduce the water cycle volume, thus affect the heating function and operation reliability.
- 5.Check whether pumps and water valves are normal working or not, whether water tubing and water pipes connector are leakage or not.
- 6.The unit and around should remain clean, well-ventilated. Regularly clean (1-2 month)the side air heat exchanger to maintain a good effect of heat exchange.
- 7.Frequently check whether each part of the unit work normal or not, check whether there is oil on the pipeline joints and charging valve to ensure that no refrigerant leakage.
- 8.Do not piling up debris around the unit, so as not to block from air inlet and outlet, the unit around should be kept clean the dry, well-ventilated.
- 9.If the unit stops for a longer time, should drain all the water in the pipeline, cut off power supply, and sets the protective equipment.When re-run the unit, complete inspection is a must before reboot.
- 10.When unit failure, and the user can not resolve the problem, please call our Company in local maintenance department, in order to promptly send people for maintenance.
- 11.Host condenser cleaning.We propose to use 50°C-60°C, and 15% hot phosphoric acid for condenser cleaning, launch the circulating pump of the host unit for three hours' cleaning, finally rinse with water three times. (Propose to back up a 3-way connector when installing the pipeline, block one joint),in order to clear the connection pipe. Do not use corrosive cleaning fluid for condenser cleaning.
- 12.Water tanks need to remove theWater scale after some time (normally two months, according to the water quality of local place).

Air Source Heat Pump-Water Heater
