

SWIMMING POOL

HEAT PUMP UNIT

Installation & Instruction Manual

— English Version —

SWIMMING POOL HEAT PUMP

Contents

Performance Data Specifications

1.Performance data of Swimming Pool Heat Pump Unit -----	1
2.The dimension for Swimming Pool Heat Pump --- -----	2
3.Wire controller operation guide-----	3
4.Maintenance-----	7
5.Malfunction and solution -----	7
6.Wiring diagram-----	8

Service

1.How to Obtain Service-----	9
-------------------------------------	----------

Attachment

1.The charts displayed for outdoor pool & indoor pool -----	9
2.The Installation about Heat Pump & Chlorinator-----	12
3.Common Units Conversion-----	13

SWIMMING POOL HEAT PUMP

Specification

1. Performance data of Swimming Pool Heat Pump Unit

Model		SBR-70.0H-A-S	
Rated Heating Capacity	W	70000	
	BTU/h	238000	
Rated Cooling Capacity	W	50800	
	BTU/h	173000	
Heating Range	℃	15~40	
Cooling Range	℃	8~30	
Heating Input Power	W	16320	
Cooling Input Power	W	15870	
Running Current Heating	A	25.4×3	
Running Current Cooling	A	24.0×3	
COP	W/W	4.5	
EER	W/W	3.2	
Power Supply	V/PH/Hz	380V/3/50	
Compressor Type		Scroll	
Compressor Nos.		3	
Fan Motor Nos.		3	
Fan Motor Input	W	250×3	
Fan Speed	RPM	830	
Noise	dB(A)	65	
Water Connections	inch	2-1/2	
Water Flow Volume	m ³ /h	14-24	
Water Pressure Drop	Kpa	18	
Unit Dimension	L	mm	2037
	W		1037
	H		1360
Packing Dimension	L	mm	2165
	W		1130
	H		1520
Weight	Net Weight	kg	450
	Gross Weight		550

Measurement conditions:
 outdoor air temp:24℃/19℃, inlet water temp:27℃

SWIMMING POOL HEAT PUMP

2. The dimension for Swimming Pool Heat Pump

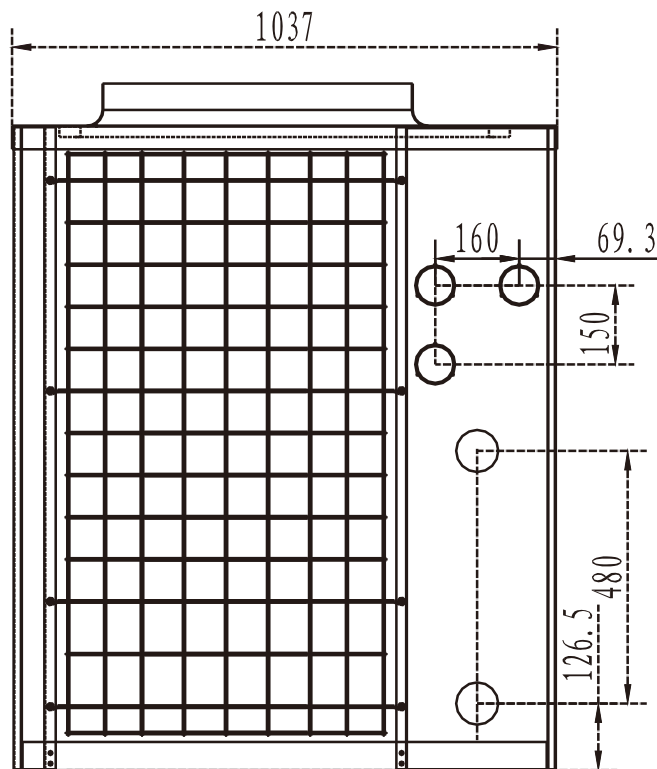
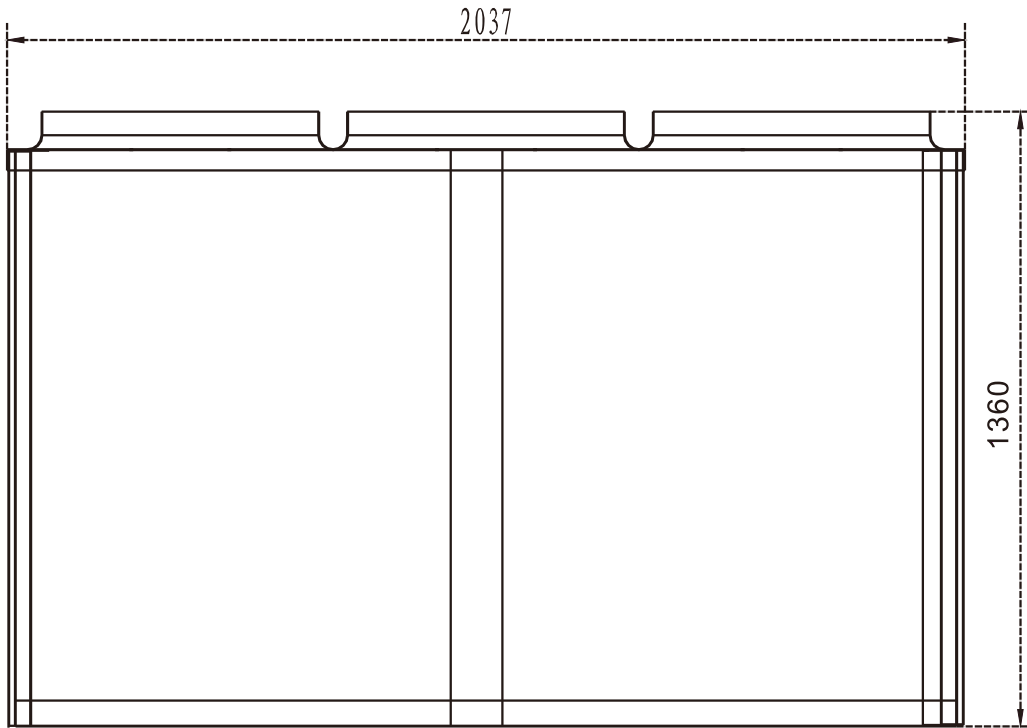

SWIMMING POOL HEAT PUMP

3. Wire controller operation guide

The functions of the wire controller

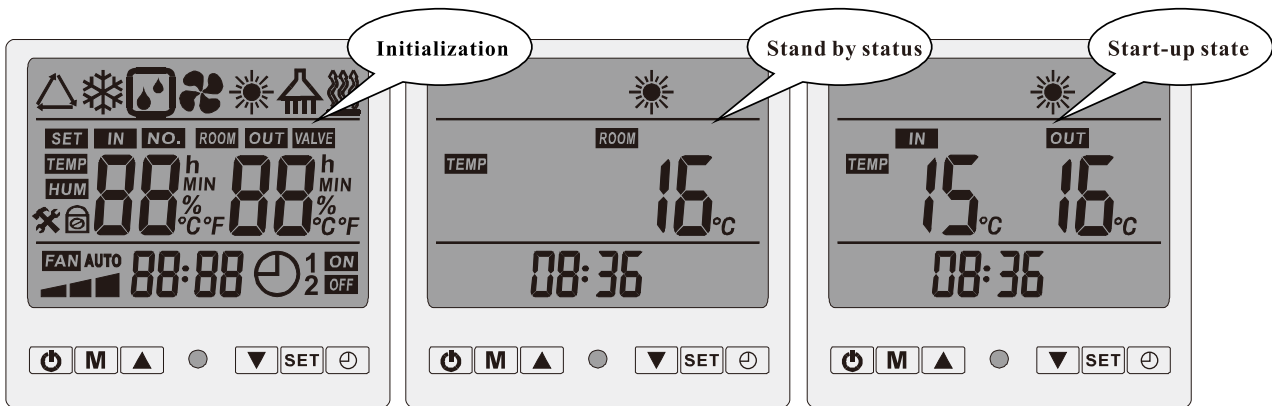

Remarks: Standby status means the unit is connected with electricity but not running.

1) Wire Controller Button Definition

◎ "☰" Button-----To turn on or turn off your heat pump

You may turn on or turn off the heat pump in any state.

◎ "M" "button-----Button for different mode

Press this button to switch the working mode. Continuously press this button , the modes circularly switches as follow.

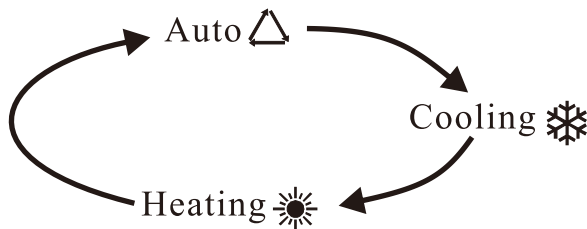

Remark: water cooler (0)with cooling mode only

water heater (3)with heating mode only

water cooler and heater(1)and electric heater(2) with auto, cooling , heating , 3 modes.

◎ "▲" "button and" ▼ "button-----Up and down button

Integrating with "SET" button to check or change each data value.

◎ "SET" "button-----Button for setting

Integrating with "▲" " button and" ▼ " button to check or change each data value.

◎ "⌚" "button-----Button for timing

Integrating with "▲" "and" ▼ "button, to set the time for turning on or turning off the heat pump .

If you choose the model with electric heater,press this button may start or shut off the electric heater.

SWIMMING POOL HEAT PUMP

2) Wire Controller Operation

◎ Check the working status

In the state of OFF, LCD display ambient temperature , In th state of ON, LCD display water in temperature and water out temperature ; In the default state, press " ▲ " or " ▼ " once, may check P1、 P2 and ROOM states; In the checking mode, if not pressing any buttons in 5 seconds, system will auto exit the checking mode and return to default state.

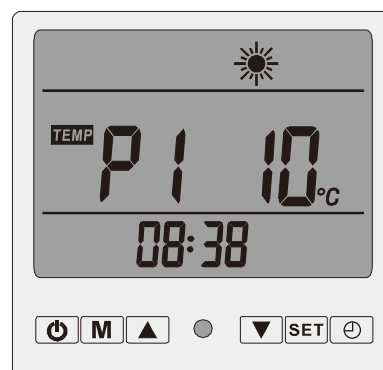

State	State content	Range	Remark
IN	Water inlet temperature	-9°C ~99°C	Actual tested value
OUT	Water outlet temperature	-9°C ~99°C	Actual tested value
P1	Coil 1 temperature	-9°C ~99°C	Actual tested value
P2	Coil 2 temperature	-9°C ~99°C	Preservation
ROOM	Ambient temperature	-9°C ~99°C	Actual tested value

◎ Parameter checking and Setting

You may enter parameter checking state from any other states by pressing " SET " once. In the state of Parameter Checking, each press on " SET " can check the next data(circularly checking), from 00 to 17 totally 18 parameter' status.

Parameter 0 and Value 1 on Parameter Checking State, you can directly press " ▲ " or " ▼ " for setting.

In the state of Parameter Checking , press AT THE SAME TIME " ▲ " AND " ▼ " for 3 seconds, vibrator "dee" for once to enter other parameter setting ,at this moment , press " ▲ " or " ▼ " may set each parameter, press " SET " to check different parameter.

In the state of Parameter Checking or Parameter Setting, if not pressing any button within 5 seconds, the system will exit Parameter Checking or Setting State and return to the default state.

(parameter from 0-C, see the Operation Parameter Table)

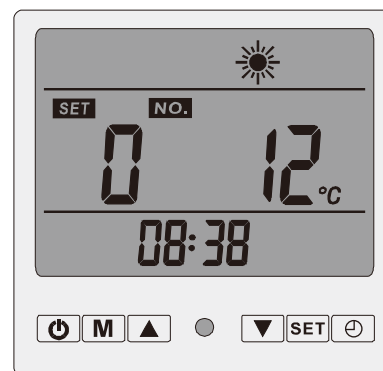

SWIMMING POOL HEAT PUMP

**The unit's operation data can be set on the wire controller.
Please set according to below table:**

Digit	meaning	Range	Default	Remark
00	Target Temperature (Auto mode)	8°C ~40°C	35°C	Adjustable
01	Target Temperature (Cooling mode)	8°C ~28°C	12°C	Adjustable
02	Target Temperature (Heating mode)	10~40°C	40°C	Adjustable
03	Defrost cycle	10~90Min	45Min	Adjustable
04	Initiate temperature for defrost	-9~-1°C	-3°C	Adjustable
05	Temperature to exit defrost	5~25°C	20°C	Adjustable
06	Defrost time	5~18Min	10Min	Adjustable
07	Mode(0:cooling/1:heat pump/ 2:electric heating(invalid)/ 3:heating)	0/1/2/3	1 heat pump (cooling+heating)	Adjustable
08	Temperature compensation	-10°C ~10°C	0°C	Adjustable
09	Circulation pump mode	Mode 0(non-stop running) , Mode 1(stop after compressor stops for 60 seconds)	0	Adjustable
10	Water temperature differential	1°C ~5°C	2°C	Adjustable
11	Water in temperature	-20~99°C		Actual testing value
12	Water out temperature	-20~99°C		Actual testing value
13	Ambient temperature	-20~99°C		Actual testing value
14	Defrost temperature 1	-20~99°C		Actual testing value
15	Defrost temperature 2	-20~99°C		Actual testing value
16	Defrost temperature 3	-20~99°C		Actual testing value
17	reserved			

◎ Real Time Clock Setting



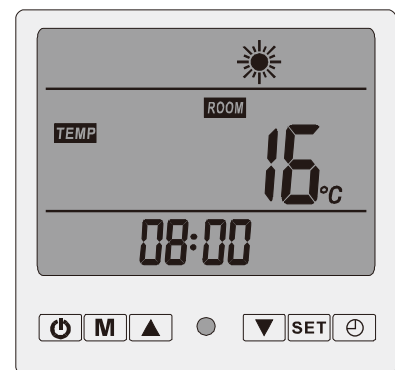











In the default state, long press " **SET** " for 3 seconds to enter Real Time Clock Setting State;
In the state of Real Time Clock Setting, press " **SET** " once again, hour numbers flash, press " **▲** " or " **▼** ", can adjust the hour for the clock.
After the clock hour is setted, press " **SET** " once again, minute numbers flash, press " **▲** " or " **▼** ", can adjust the minute for the clock.
After setting the clock minute, press " **SET** " again to confirm the clock setting and return default state.



In the state of Real Time Clock Setting, if not pressing any button within 5 seconds, the system will confirm the clock setting and return to default state.
In the state of Real Time Clock Setting, press " **⏻** " once, confirm current setting value for clock, return to default state and change the ON/OFF state.



SWIMMING POOL HEAT PUMP

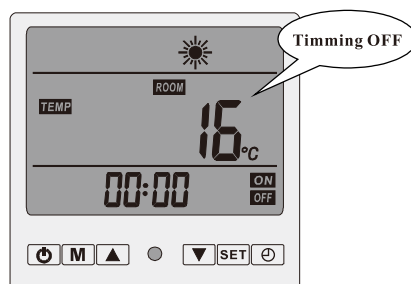
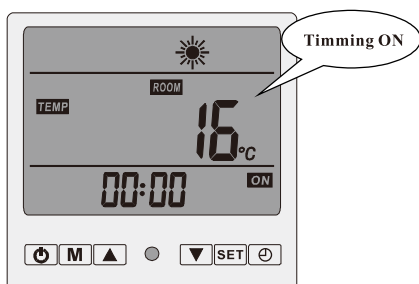

◎ Timming ON /OFF Setting

- ☆ On main interface, press “” to switch among 3 sets of Timer setting.
- ☆ After entering the Timer On setting interface, press “” once to enter current Timer On setting interface, at this moment, the hour time of clock shows and flashes, press “” or “” to roll up or down to set/adjust the Timer On hour time.
- ☆ After setting hour time for the Timer, press “” once, only minute of the clock shows and flashes, then press “” or “” to roll up or down to set the timer on minute.
- ☆ After setting the minutes, press “” once to confirm and save all the Timer On setting ,and switch to Timer Off setting interface. At this moment, the hour of clock shows and flashes, press “” or “” to roll up or down to set the Timer Off hour .
- ☆ After setting Timer Off hour, press “” once, only minute of the clock shows and flashes, then press “” and “” to roll up and down to set the timer Off minute.
- ☆ After setting the Timer Off Minutes, press “” once, to confirm and save all the setting for Timer On/Off and return to 3 sets Timer switching interface.
- ☆ When the time for current set of Timer On and Timer Off is the same, system will automatically cancel the Timer On /Timer Off function.



◎ Keyboard Lock & Unlock

In default state, long press “” and “” for 3 seconds AT THE SAME TIME , vibrator "bee" once , the keyboard will be locked.

In the state of Locked, long press “” and “” for 3seconds, vibrator "bee" for once, the keyboard will be unlocked.

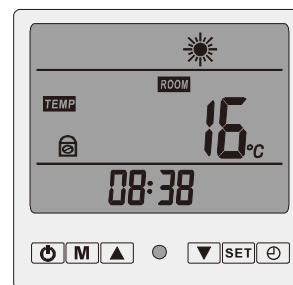

◎ Back Up Memory After Power Resumption

When the heat pump is working in normal state and electricity power cut off suddenly, the system will run in the last setting record after power resumption.

◎ Setting about S1 & S2 switch

S1 Switch---Long distance demand for heating

S2 Switch---Long distance demand for cooling

Please refer to the wiring diagram for the location of S1 and S2 switch.

- 1) Heat pump turns on when S1 or S2 switch has well connected. While S1 or S2 has connected, suddenly press the off button on the LCD controller. Heat pump will stop for 3 minutes. However, heat pump continues to turn on if S1 or S2 still has been connected after 3 minutes.
- 2) The Timer function is out of validity either S1 or S2 switch has connected.
- 3) Heat pump turns off when S1 or S2 switch is disconnected. Meanwhile, need to use LCD controller to turn on /off the heat pump.

SWIMMING POOL HEAT PUMP

4. Maintenance

- To check the water supply device often. You should avoid the condition of no water or air entering into system, or that will influence unit's performance and reliability. You should clear the water filter regularly to avoid unit's damage by filter' jam.
- There should be dry, sanitary and ventilation around the unit. To clean the side condenser regularly for good heating exchanging and saving energy.
- To check the power supply and cable connection often, to see if there is abnormal action or bad smell about the electrical component. If yes, Contact Installer immediately.
- Please discharge all water in the water pump and water system lest freeze the water pump or water system. You should discharge the water at the bottom of water pump if the units will stop for long time. And you should check the units thoroughly and fill the system with water fully before power on the units again.

5. Malfunction and solution

Wire Controller display	Malfunction	Remark
00E	Phase sequence failure	non-recoverable
01E	water flow failure	recoverable30
03E	system 1 high pressure failure	If repeat the same failure in 3 times within 30 minutes, non-recoverable unless power off and restart
04E	system 1 low pressure failure	If repeat the same failure in 3 times within 30 minutes, non-recoverable unless power off and restart
07E	system 2 high pressure failure	If repeat the same failure in 3 times within 30 minutes, non-recoverable unless power off and restart
08E	system 2 low pressure failure	If repeat the same failure in 3 times within 30 minutes, non-recoverable unless power off and restart
18E	system 3 high pressure failure	If repeat the same failure in 3 times within 30 minutes, non-recoverable unless power off and restart
19E	system 3 low pressure failure	If repeat the same failure in 3 times within 30 minutes, non-recoverable unless power off and restart
20E	reserved	reserved
21E	reserved	reserved
22E	Water in and water out temperature differential too large	If repeat the same failure in 3 times within 30 minutes, non-recoverable unless power off and restart
23E	Cooling mode over-cooled protect	recoverable
09E	Communication failure(Main PCB board and LCD display controller lost communication for 2 minutes)	
11E	defrost sensor 1 failure	
10E	defrost sensor 2 failure	
16E	defrost sensor 3 failure	
17E	reserved	reserved
12E	Ambient sensor failure	recoverable
13E	Water out sensor failure	recoverable
15E	water in sensor failure	recoverable
Lt	Anti-freezing protect	
02E1	Current 1 failure	If repeat the same failure in 3 times within 30 minutes, non-recoverable unless power off and restart
02E2	Current 2 failure	If repeat the same failure in 3 times within 30 minutes, non-recoverable unless power off and restart
02E3	Current 3 failure	If repeat the same failure in 3 times within 30 minutes, non-recoverable unless power off and restart
02E4	reserved	reserved

SWIMMING POOL HEAT PUMP

6. Wiring diagram

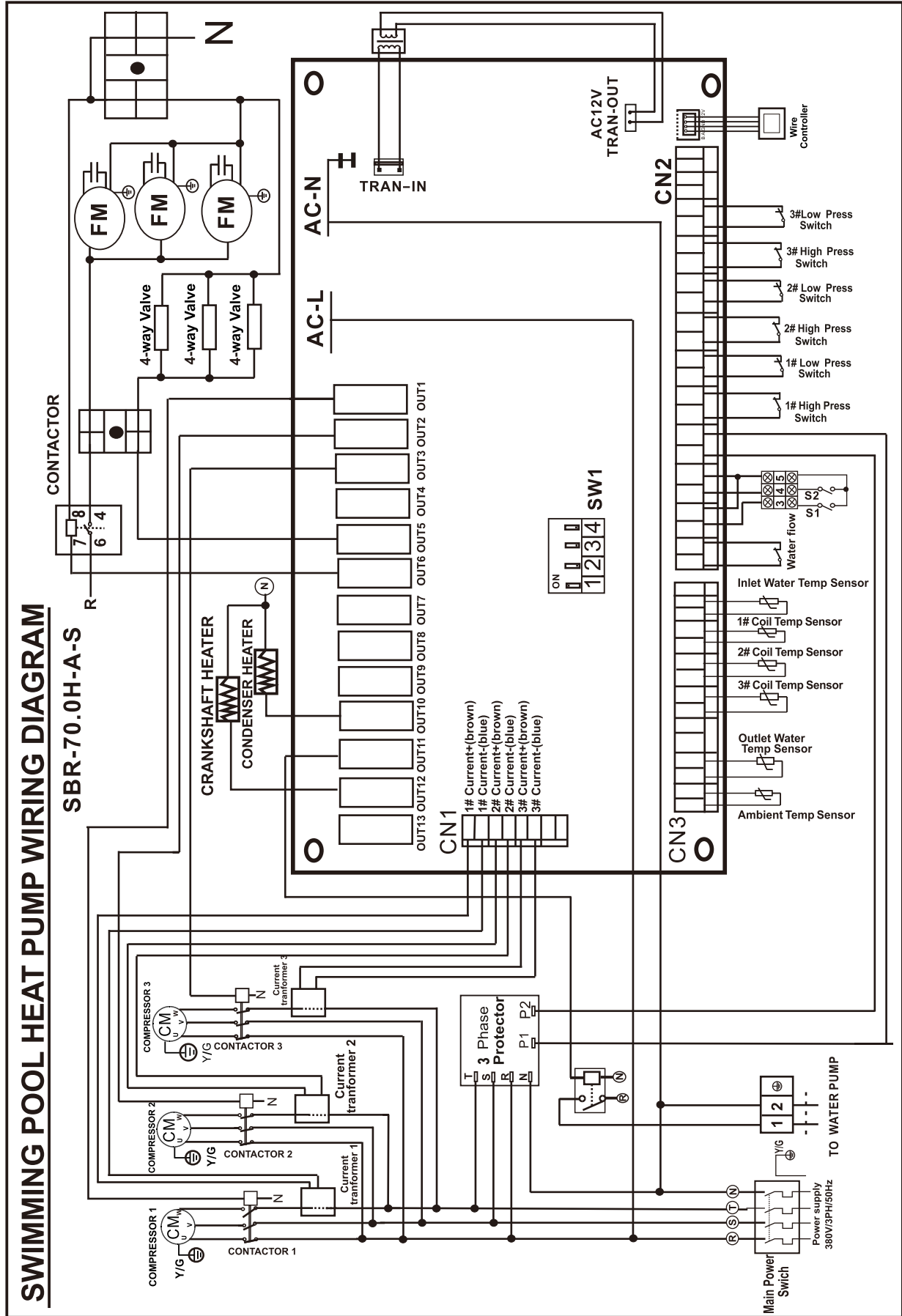

SWIMMING POOL HEAT PUMP

Service

1. How to obtain Service For Pool Owner

If you are having trouble with the unit, please contact the Installer immediately.

1. Provide your Dealer with the following information:

- A. Serial # located on back panel nameplate .
- B. Proof of Installation Date(Bill of sale or original invoice only)
- C. Description of the Symptoms

2. For Installing Dealer

If your customer is having a problem and you as the installing dealer have verified that the cause is NOT external to my company(such as tripped breaker, clogged pool filter, inadequate pump run time, etc.) following these steps will help you obtain the fastest service possible for your customer.

1. Help your customer gather the following information:

- A. Serial # located on back panel nameplate .
- B. Proof of Installation Date(Bill of sale or original invoice only)

3. Will Ever Need Freon

Unless there is a leak in the sealed refrigeration system, the factory charge of freon should last for the life of the unit. Freon is very stable and should not degrade or breakdown even under severe operating conditions. If your unit needs freon, then it has a leak, and adding freon will not solve the problem. The leak must be located and repaired. Fortunately, freon leaks are very uncommon and usually are due to shipping.

Attachment 1

SWIMMING POOL HEATING SYSTEM EVALUATION

1. The charts displayed for an outdoor pool

Energy flows in a heated pool

Energy flows in an unheated pool

Pool temperature

Range of pool temperature(max exceeded for 5% of the time and mini temperature exceed for 95% of the time.)

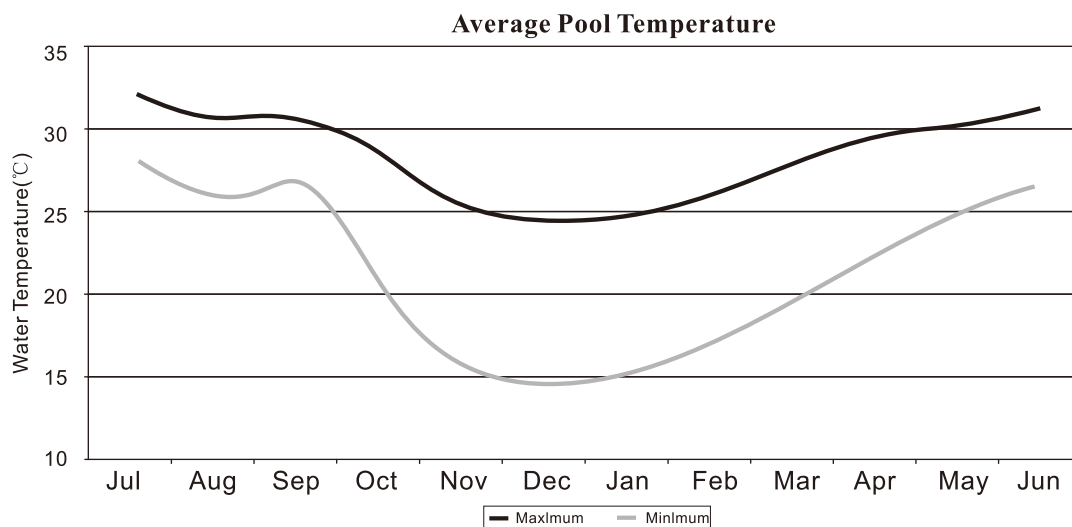

SWIMMING POOL HEAT PUMP

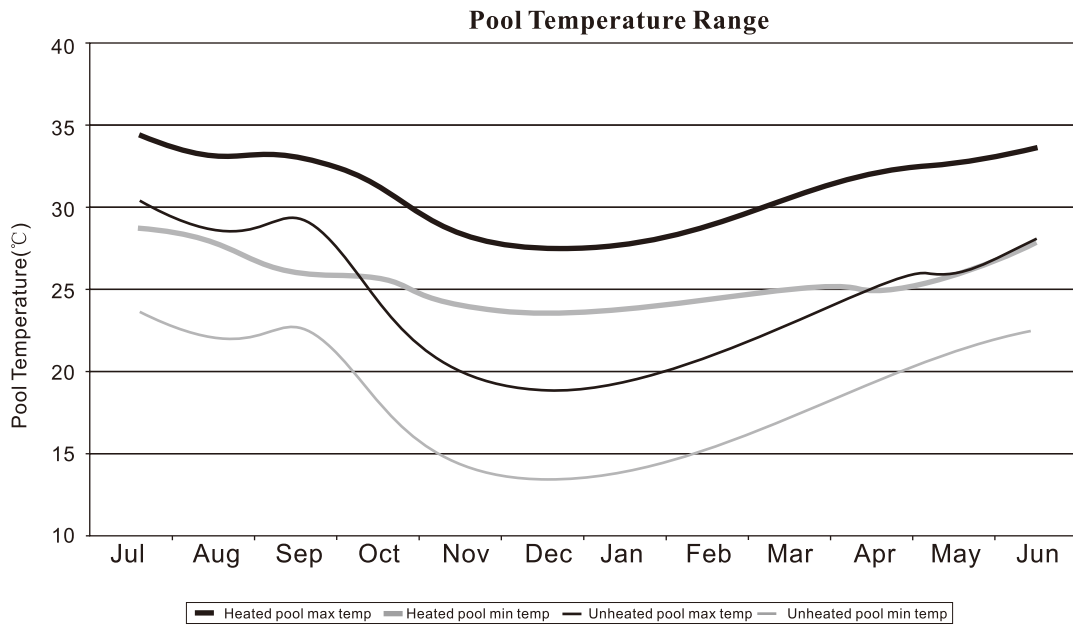

2. The charts displayed for an indoor pool are

- Energy flows for indoor pool.
- Pool temperature during daytime operating period.
- Space temperature during daytime operating period.
- Space humidity during daytime operating period.
- Pool temperature at night.
- Space temperature at night.
- Space humidity at night.

Some of the charts are.

**Pool Temperature
operating period**

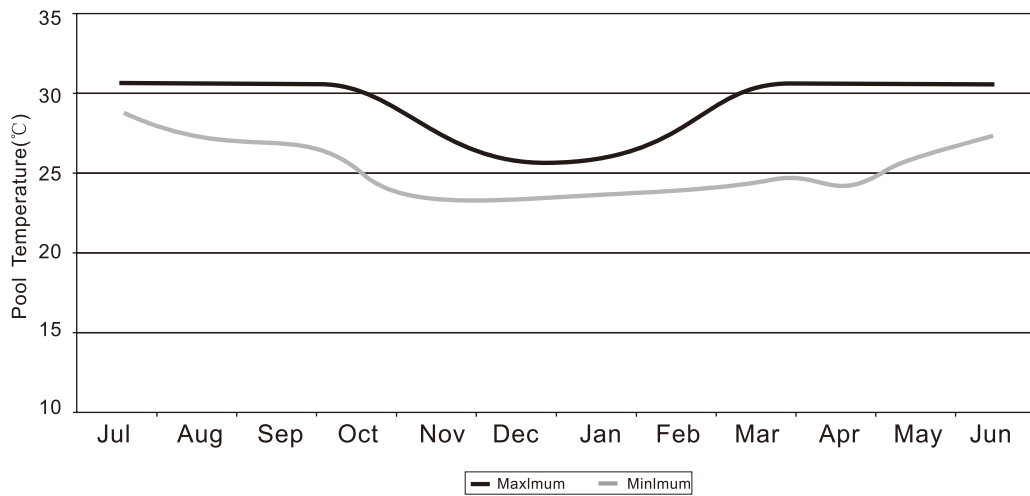

SWIMMING POOL HEAT PUMP

Space Temperature operating period

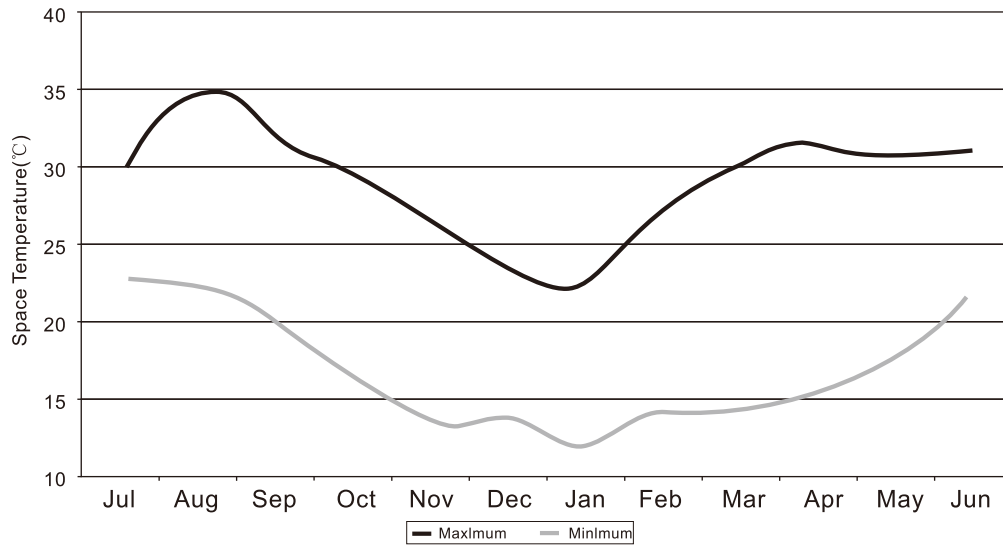

Space Humidity operating period

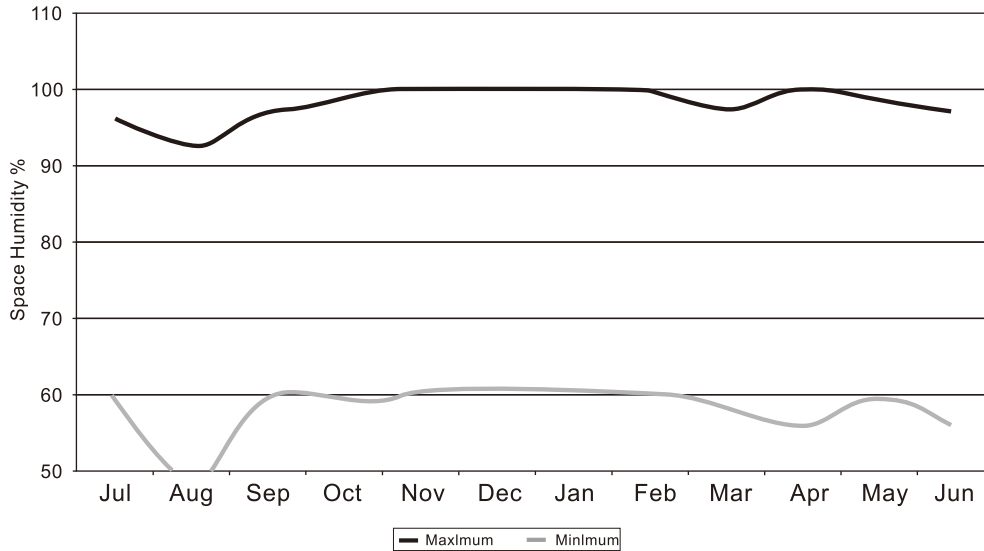

The position of installing unit

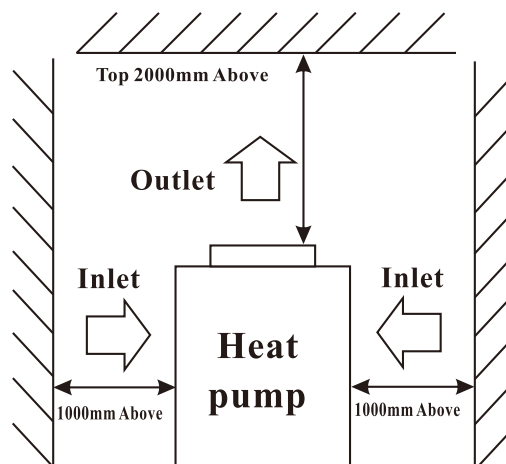

SWIMMING POOL HEAT PUMP

Attachment 2

The Installation about Heat Pump & Chlorinator

In-line Chlorinator or Brominator

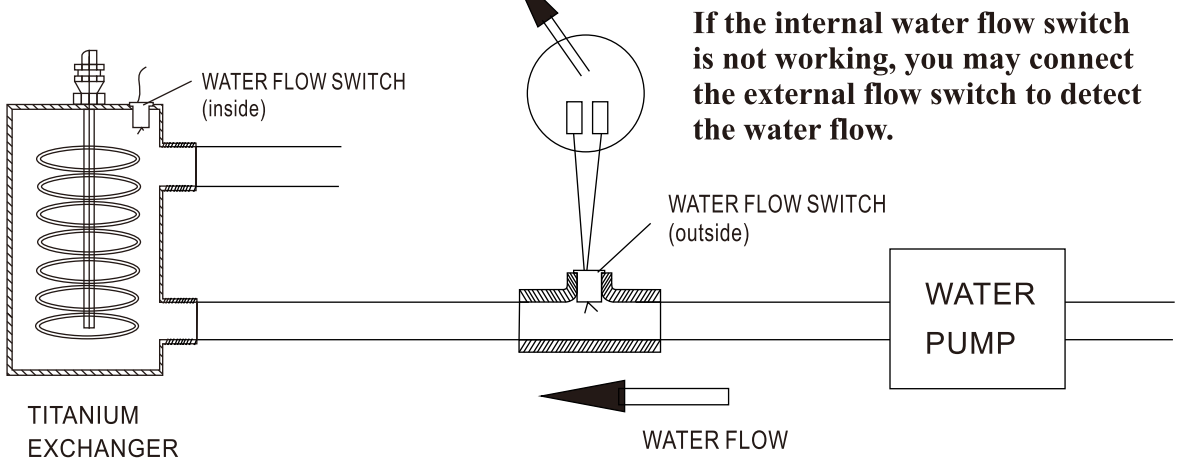
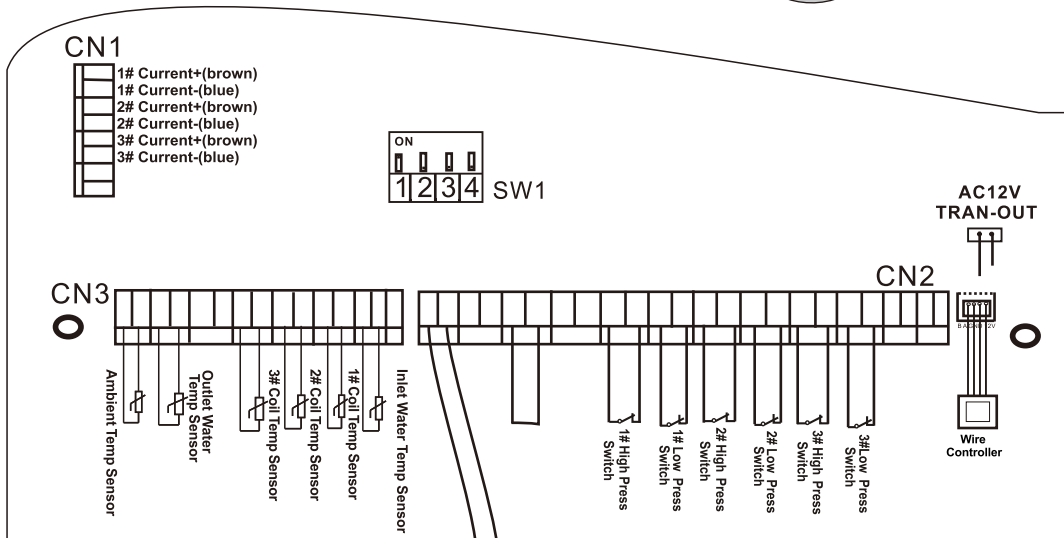
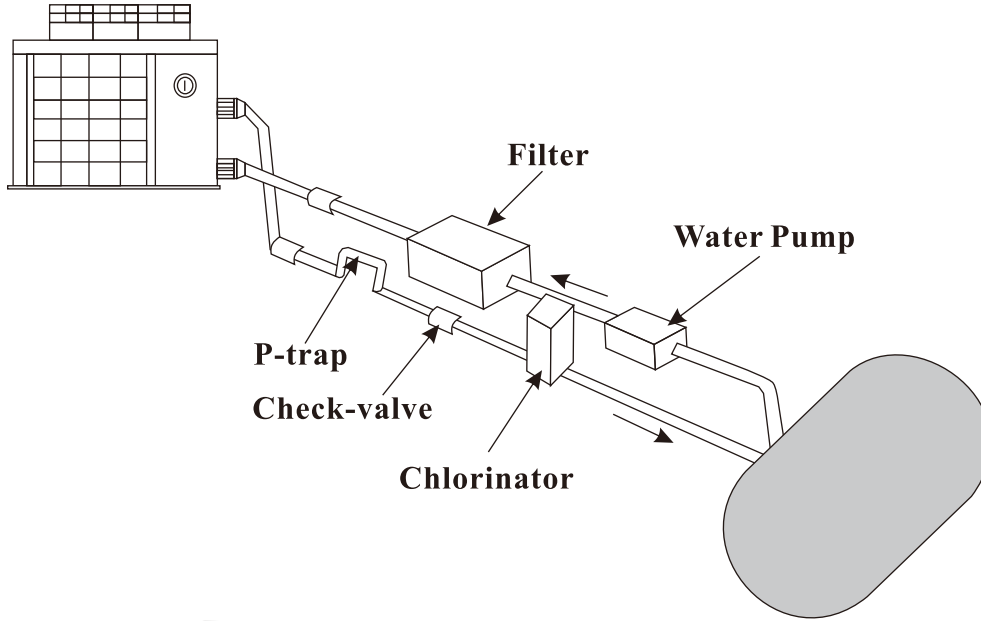

SWIMMING POOL HEAT PUMP

Attachment 3

Common Units Conversion

Linear Measure

1 inch=25.4 millimetres
1 foot=12 inches=0.3048 metre
1 yard=3 feet=0.9144 metre
1 (statute)mile=1760 yards=1.609 kilometres
1 nautical mile=1852 m.

Square Measure

1 square inch=6.45 sq.centimetres
1 square foot=144 sq.in.=9.29 sq.decimetres
1 square yard=9 sq.ft.=0.836 sq.metre
1 acre=4840 sq.yd.=0.405 hectare
1 square mile=640 acres=259 hectares

Cubic Measure

1 cubic inch=16.4 cu.centimetres
1 cubic foot=1728 cu.in.=0.0283 cu.metre
1 cubic yard=27 cu.ft.=0.765 cu.metre

Capacity Measure

British

1 pint 20 fluid oz.=34.68 cu.in.=0.568 litre
1 quart=2 pints=1.136 litres
1 gallon=4 quart=4.546 litres
1 peck=2 gallons=9.092 litres
1 bushel=4 pecks=36.4 litres
1 quarter=8 bushels=2.91 hectolitres

American dry

1 pint=33.60 cu.in.=0.550 litre
1 quart=2 pints=1.101 litres
1 peck=8 quarts=8.81 litres
1 bushel=4 pecks=35.3 litres

American liquid

1 pint=16 fluid oz.=28.88 cu.in.=0.473 litre
1 quart=2 pints=0.946 litre
1 gallon=4 quarts=3.785 litres

Avoirdupois Weight

1 grain=0.065 gram
1 dram=1.772 grams
1 ounce=16 drams=28.35 grams
1 pound=16 ounces=7000 grains=0.4536 kilogram
1 stone=14 pounds=6.35 kilograms
1 quarter= 2 stones=12.70 kilograms
1 hundredweight=4 quarters=50.80 kilograms
1 short ton=2000 pounds=0.907 tonne
1 (long)ton=20 hundredweight=1.016 tonnes

energy, power

1 usrt=3024 kcal/h=3516 w
1 kcal/h=1.163 w
1 kw=860 kcal/h
1 btu/h=0.293 w

velocity, flux

1 m/s=196.85 fpm
1 cfm=1.699 cmh
1 gpm=0.27276 cmh
1 gpm=0.2271 cmh

Pressure

1 bar=100000 pa
1 psi=0.0703 kgf/cm²
1 kgf/cm²=98000 pa
1 mm aq.=9.8 pa
1 mm hg=133.28 pa
1 m H₂O=9800 pa=0.1 kgf/cm²

