

# ***SWIMMING POOL***

## ***HEAT PUMP UNIT***

### **Installation & Instruction Manual**

— English Version —

**Model: SBR-70.0-A-S**

# *Contents*

## **Performance Data Specifications**

<b>1.Performance data of Swimming Pool Heat Pump Unit</b> -----	<b>1</b>
<b>2.The dimension for Swimming Pool Heat Pump</b> ---	<b>2</b>
<b>3.Wire controller operation guide</b> -----	<b>3</b>
<b>4.Maintenance</b> -----	<b>15</b>
<b>5.Wiring diagram</b> -----	<b>16</b>

## **Service**

<b>1.How to Obtain Service</b> -----	<b>17</b>
<b>2.For Installing Dealer</b> -----	<b>17</b>
<b>3.Will Ever Need Freon</b> -----	<b>17</b>

## **Attachment**

<b>1.The charts displayed for outdoor pool &amp; indoor pool</b> -----	<b>17</b>
<b>2.The Installation about Heat Pump &amp; Chlorinator</b> -----	<b>19</b>
<b>3.Common Units Conversion</b> -----	<b>20</b>

<b>Mac No. of this unit:</b>	
------------------------------	--

## **Dear customers:**

In order to use this machine safely, please read this user's manual carefully before using and installation, especially pay attention to each notice remark for usage and maintenance. Also keep it carefully for later use. Heat pump water heater is a professional machine, it may cause damage or hazard when wrong installed. Relevant installation and maintenance shall be done by technical people. Please contact our installation service for reference.



### **Important warning:**

- This appliance can be used by children aged from 8 years and above and persons with reduced physical, sensory or mental capabilities or lack of experience and knowledge if they have been given supervision or instruction concerning use of the appliance in a safe way and understand the hazards involved.  
Children shall not play with the appliance. Cleaning and user maintenance shall not be made by children without supervision.
- Children should be supervised to ensure that they do not play with the appliance.
- The specifications of fuse is: AC250V, 3.15A.
- The appliance must be fitted with means for disconnection from the supply mains having a contact separation in all poles that provide full disconnection under overvoltage category III conditions and these means must be incorporated in the fixed wiring in accordance with the wiring rules.  
Please make sure that the unit and power connection have good earthing, otherwise may cause electrical shock..
- The running range of the heat pump:
  - (1) Heating : outlet water range:15 ~40°C, the ambient temperature range 0 ~ 32°C;
  - (2) Cooling : outlet water range:8 ~30°C, the ambient temperature range 20 ~ 43°C;
  - (3) the pressure of water : 14 ~ 18kpa
- Do not forget to connect the ground wire
- Use an exclusive power source with a circuit breaker

# ***SWIMMING POOL HEAT PUMP***

---

## **1. Performance data of Swimming Pool for A type**

Model		SBR-70.0H-A-S	
Rated Heating Capacity	W	70000	
	BTU/h	238000	
Rated Cooling Capacity	W	50800	
	BTU/h	173000	
Heating Range	℃	10~40	
Cooling Range	℃	8~28	
Heating Input Power	W	16320	
Cooling Input Power	W	15870	
Running Current Heating	A	25.4×3	
Running Current Cooling	A	24.0×3	
COP	W/W	4.5	
EER	W/W	3.2	
Power Supply	V/PH/Hz	380V/3/50	
Compressor Type		Scroll	
Compressor Nos.		3	
Fan Motor Nos.		3	
Fan Motor Input	W	250×3	
Fan Speed	RPM	830	
Noise	dB(A)	65	
Water Connections	inch	2-1/2	
Water Flow Volume	m <sup>3</sup> /h	14-24	
Water Pressure Drop	Kpa	18	
Unit Dimension	L	mm	2037
	W		1037
	H		1360
Packing Dimension	L	mm	2165
	W		1130
	H		1520
Weight	Net Weight	kg	395
	Gross Weight		455

Measurement conditions:  
 outdoor air temp:24℃/19℃, inlet water temp:27℃

# SWIMMING POOL HEAT PUMP

---

## 2. The dimension for Swimming Pool Heat Pump

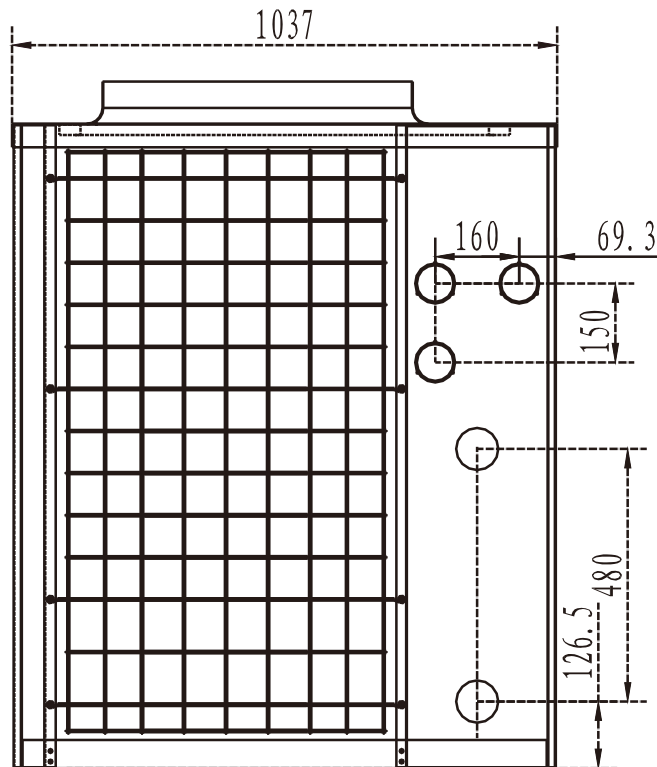
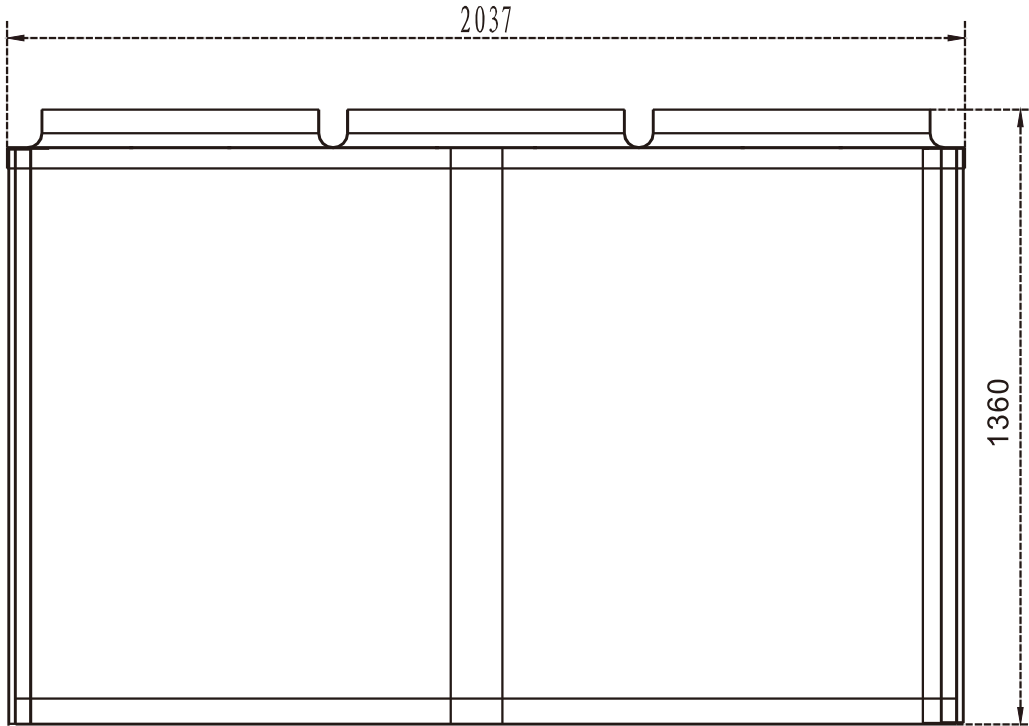







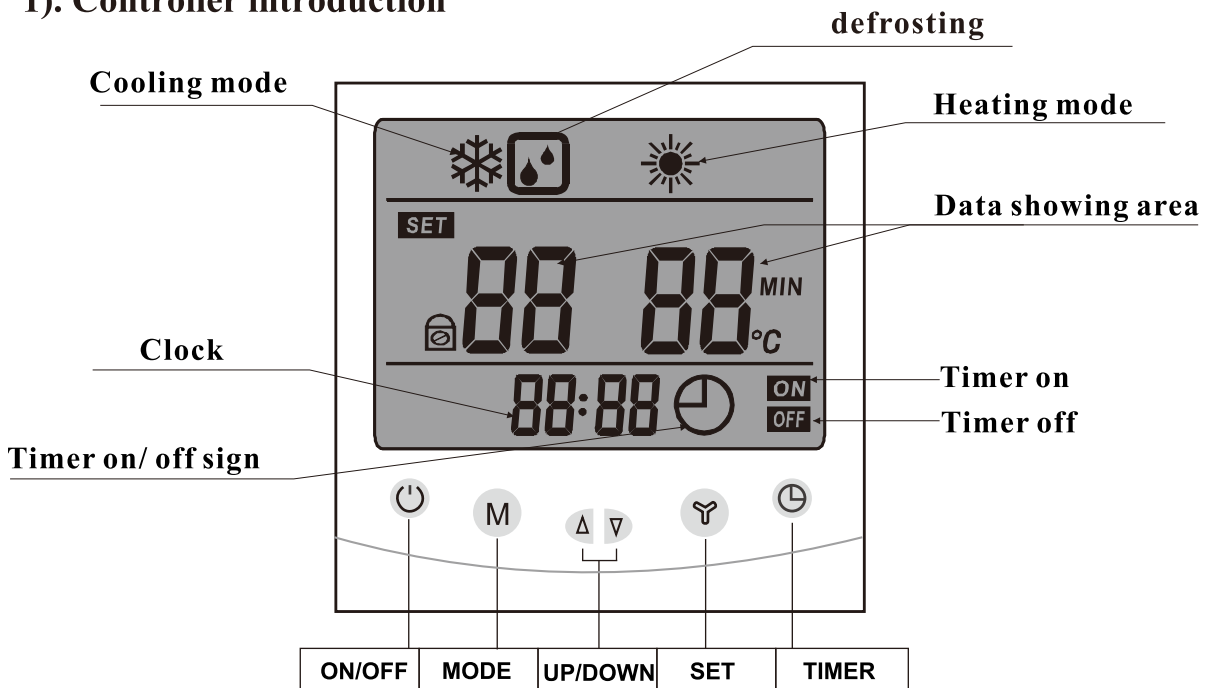











# SWIMMING POOL HEAT PUMP

## 3. Wire controller operation guide

### 1). Controller introduction



### 2) Wire controller button definition

-  button  
---to turn on or turn off your heat pump.
-  button  
-----up and down button to check or change setting.  
Press these two button at the same time for 3seconds, lock the keyboard.
-  button  
—Change setting. While use  or  button to check parameter, press  button at the moment, could change the setting of current parameter.  
After finished, press  to confirm.  
Press  button alone, could come to clock setting. First set the hour data, and use  or  button to change the hour data.  
Secondly press  again, to come to minute data setting. Still use  or  button to change the minuted data. After that, press  to confirm.
-  button  
---Press  button to switch to heating or cooling mode.  
---Press  for 3 seconds in standby status, could enter for Force Defrost.
-  button  
----Button for timming. Integrating with up and down button, to set the time for turning on or turning off the heat pump.

# *SWIMMING POOL HEAT PUMP*

---

## 3) Wire Controller Operation

◎ In the state of OFF, LCD display clock and working mode only. see P1



◎ When Press “power” button, heat pump turn on, and LCD display as below.

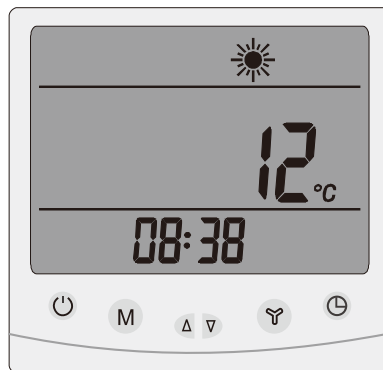

### Parameter data setting

You could check and change the setting from any status as below steps.

1. Press up/ down button for the parameter you want to change setting.

2. Press  button once, and the right data flash

3. Use up/down button to change the setting.

Press  button again for confirm.

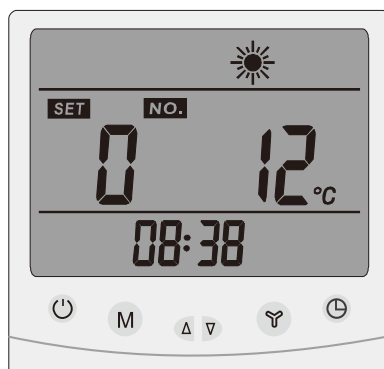

# SWIMMING POOL HEAT PUMP

## ◎ Real Time Clock Setting

In the default state, press "☺" once to enter Real Time Clock Setting State; In the state of Real Time Clock Setting, press "☺" once again, hour numbers flash, press "▲" or "▼", can adjust the hour for the clock.

After the clock hour is setted, press "☺" once again, minute numbers flash, press "▲" or "▼", can adjust the minute for the clock. After setting the clock minute, press "☺" again to confirm the clock setting and return default state.

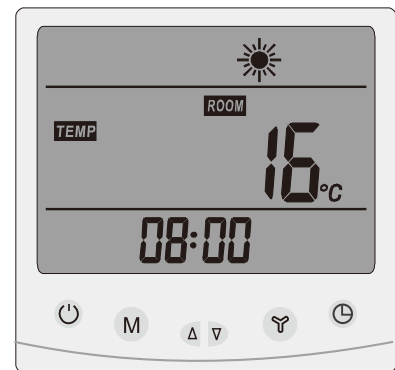

## ◎ Timming ON /OFF Setting

In default state, press "⌚" once to enter Timing Setting state. press "⌚" again, the hour numbers for timming ON flash, press "▲" or "▼" to adjust the hour for timming ON setting.

After setting the hour for timming ON, press "⌚" once again, the minute number for timming ON flash, press "▲" or "▼" to adjust the minute for timming ON. After setting the minute for timming ON, press "⌚" once again, to enter the hour setting of timming OFF;

After setting the timming OFF hour and minute, press "⌚" again, to confirm current setting and return to default state.

In the state of Timming Setting, press "☺" once, it will clear timming ON /OFF setting and return to default state.

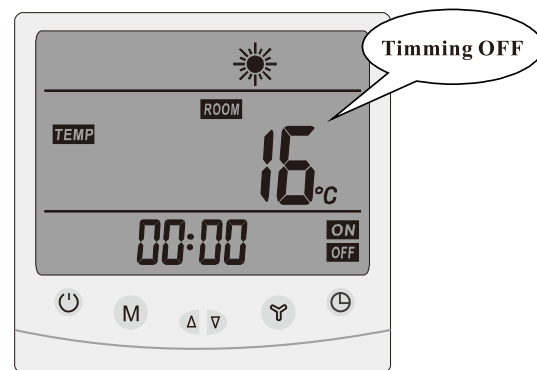
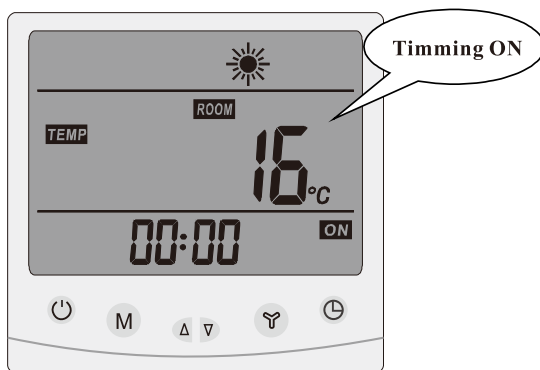

## ◎ Keyboard Lock & Unlock

In default state, long press "▲" and "▼" for 3 seconds AT THE SAME TIME, vibrator "bee" once, the keyboard will be locked.

In the state of Locked, long press "▲" and "▼" for 3seconds, vibrator "bee" for once, the keyboard will be unlocked.

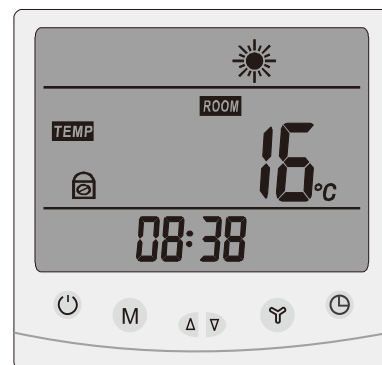

## ◎ Back Up Memory After Power Resumption

When the heat pump is working in normal state and electricity power cut off suddently, the system will run in the last setting record after power resumption.



## *SWIMMING POOL HEAT PUMP*

### 3) Parameters

Digit	Meaning	Range	Default	Remarks
SET 0	Cold water set point temp	8-25 °C	12°C	Adjustable
SET 1	Hot water set point temp	20-40°C	40°C	Adjustable
SET 2	Total working time of compressor after defrosting	30-90MIN	40MIN	Adjustable
SET 3	Setting initialization temp of defrosting	0-30°C	-7°C	Adjustable
SET 4	Temperature of exit defrost under heating model	2-30°C	13°C	Adjustable
SET 5	Time of exit defrost under heating model	1-12min	8min	Adjustable
SET 6	EEV control (Manual /Auto) (0:Manual, 1: Auto)	0-1	1	Reversed
SET 7	system quantity	1 -2	1	Adjustable
SET 8	Temp difference	2-15°C	5°C	Adjustable
SET 9	Second set point (Maximum temp)	35-40°C	40°C	Adjustable
SET A	Second set point (Minimum temp)	20-25°C	25°C	Adjustable
SET B	Working mode of water pump	0-2	0	Adjustable
	0: Compressor stop, water pump stop			
	1: water pump keep working on			
	2: Water pump stop 30min, run 3 min, repeated			
SET C	Target degree of EEV	-F(15°C) -F(15°C)	5°C	Reversed
SET D	EEV step when in Manual mode	10(100steps)~50(500steps)	35(350steps)	Reversed
SET E	E-heater start temp	-15~10°C	0°C	Reversed
1	Inlet water temp	0~99°C		Tested data/can not change
2	Outlet water temp	0~99°C		Tested data/can not change
3	Evaporator tube temp of system 1	-35~80°C		Tested data/can not change
4	Evaporator tube temp of system 1	-35~80°C		Tested data/can not change
5	Coil temp of system 1	-35~80°C		Reversed
6	Coil temp of system 2	-35~80°C		Reversed
7	Ambient temp	-35~80°C		Tested data/can not change
8	Exhaust temp of system 1	0~125°C		Tested data/can not change
9	Exhaust temp of system 2	0~125°C		Tested data/can not change
A	Actual step of EEV X10	10-47		Reversed

## ***SWIMMING POOL HEAT PUMP***

---

### **4 ) Failure code and parameter tables**

Protect/Failure	Long-distance controller	Remark
Heat ump in Stand-by mode		
Normal running		
Inlet water temperature sensor failure	PP1	
Outlet water temperature sensor failure	PP2	
Coil temperature sensor 1 failure	PP3	
Gas suction side temperature sensor 1 failure	PP4	
Ambient temperature sensor failure	PP5	
Coil temperature sensor 2 failure	PP6	
Winter anti-freezing protection I	PP7	
Winter anti-freezing protection II	PP7	
Gas suction side temperature sensor 2 failure	PP8	
Exhaust temp sensor 1 failure	PP9	
Exhaust temp sensor 2 failure	PP10	
Exhaust 1 high temp protection	PP 11	
Exhaust 2 high temp protection	PP 12	
System high pressure protection	EE1	
System low pressure protection	EE2	
Water flow switch failure	EE3	
Power source wrong/open phase	EE4	
Wire controller communication failure	EE8	
Defrosting	DEFROST	

# *SWIMMING POOL HEAT PUMP*

---

## 5) Two ways to connect wifi

### a. First way

#### ● For Android System

- Install the APP of “SmartLink3 Demo”
- Turn on the heat pump, and make sure the area of heat pump installed cover with wifi signal. What's more, make sure your smart phone with wifi connected.
- Long press the timer button of LCD controller for 5 seconds. See below pic.



**Timer button**

- Then input the password for example 12345678 of WIFI TP LINK-22233.  
**(The wifi should be your local wifi, and your password of local wifi)**  
And press “Start”, see below pic. (Your smart phone should near the controller to ensure easy connected for wifi)

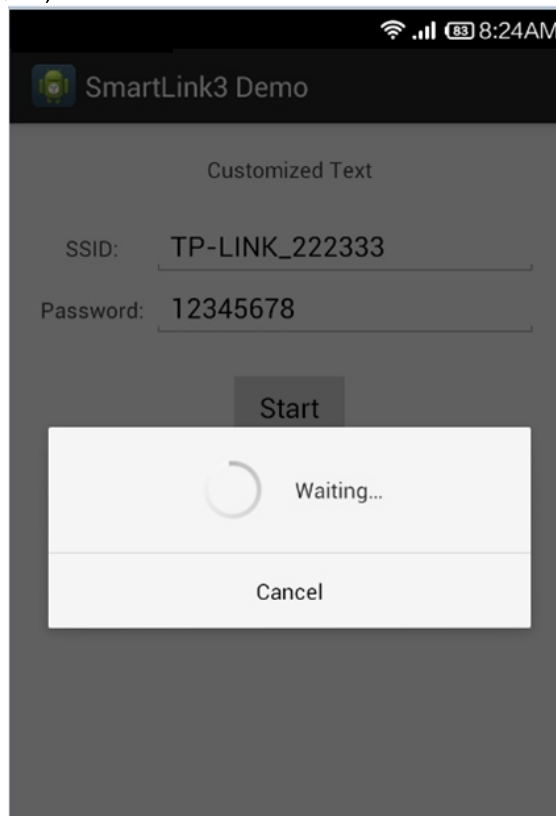

# *SWIMMING POOL HEAT PUMP*

---

## **a. First way**

- It may take 1 minute to match all wifi setting.

If connected successful, it could show “**SmartLink Compeltd**” as below pic.

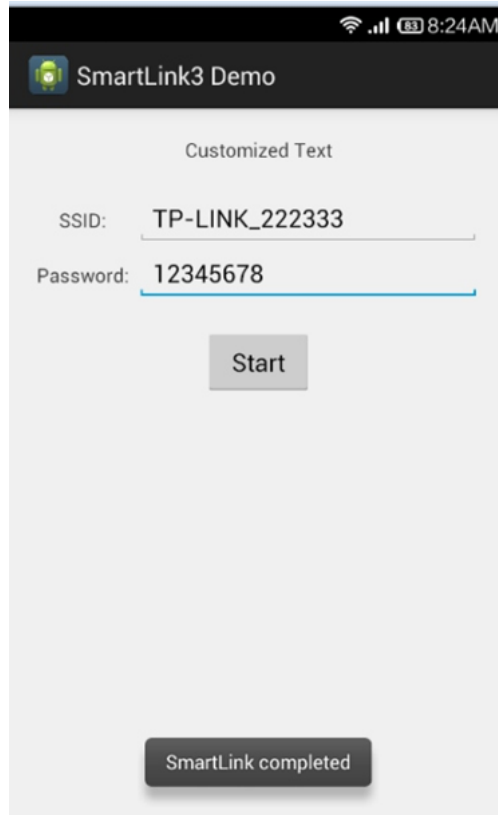

- If failed, it could show “**time out**”as below pic, then you have to repeat step 3 & 4 again.

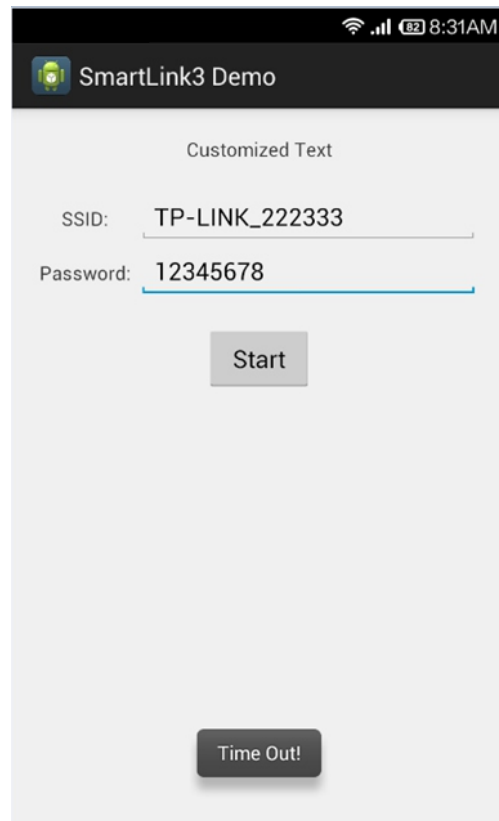

# *SWIMMING POOL HEAT PUMP*

---

## **a. First way**

### ● For IOS System

- Find out “SmartLink” in the APP Store, download and install it.

You can scan below QR code for fast installation as well.

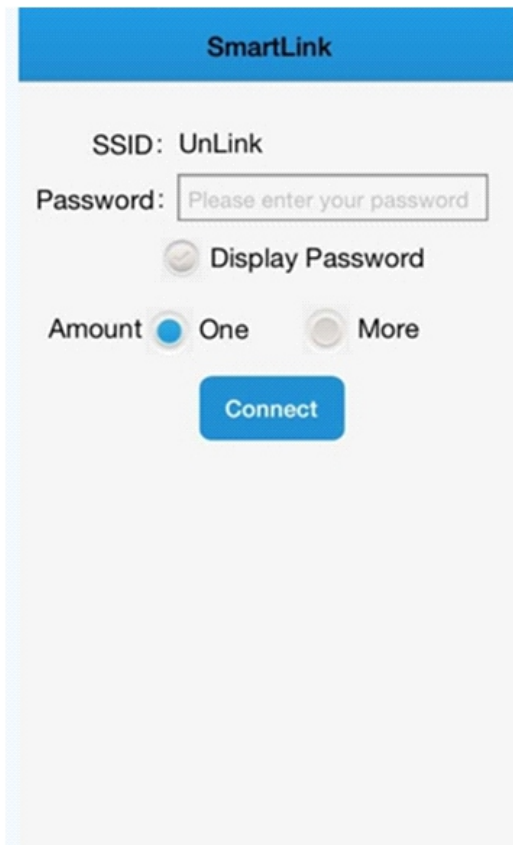

- Input the passwords of your local wifi.

A screenshot of the SmartLink app's WiFi configuration screen. The screen has a blue header with the text "SmartLink". Below the header, the SSID is displayed as "UnLink". There is a "Password:" label followed by a text input field containing the placeholder text "Please enter your password". Below the input field is a "Display Password" toggle switch, which is currently turned off. At the bottom, there are two radio button options for "Amount": "One" (which is selected) and "More". A blue "Connect" button is positioned at the bottom center of the screen.

- Other setting please refer to Android system, as they are the same.  
Remarks, initial wifi setting may need a few times to complete. Please try more times if once is not successful.

# ***SWIMMING POOL HEAT PUMP***

---

## **b. Second way for wifi setting**

- Turn on the heat pump.
- Use laptop or smart phone to find wifi “HF-LPB100”and connect it.
- Open website of “10.10.100.254” , input user name and password as below.

User name: admin Password: admin

After that, you could find below interface.



- Select work mode, change to STA mode. And then press Save. See below ref pic.

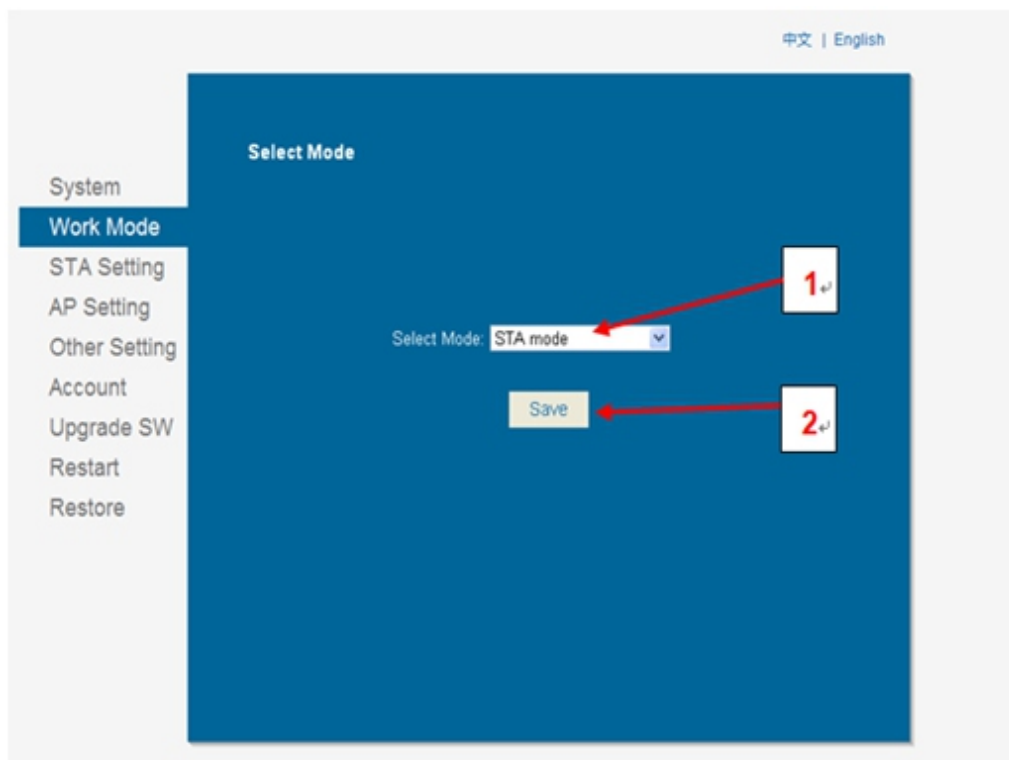

# SWIMMING POOL HEAT PUMP

## b. Second way for wifi setting

- Then select STA setting, press Scan, then press Save. See below refer pic.

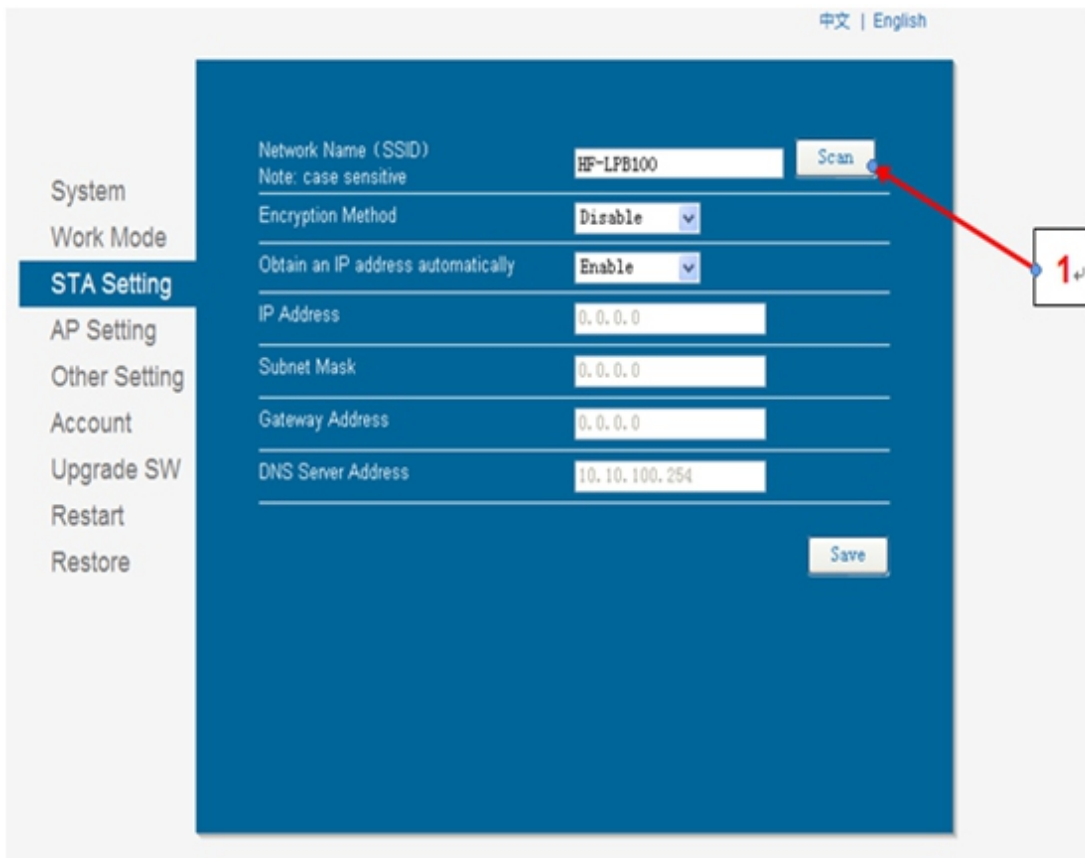

- Please choose the safety and reliable local area network which available. Then press OK to Confirm.

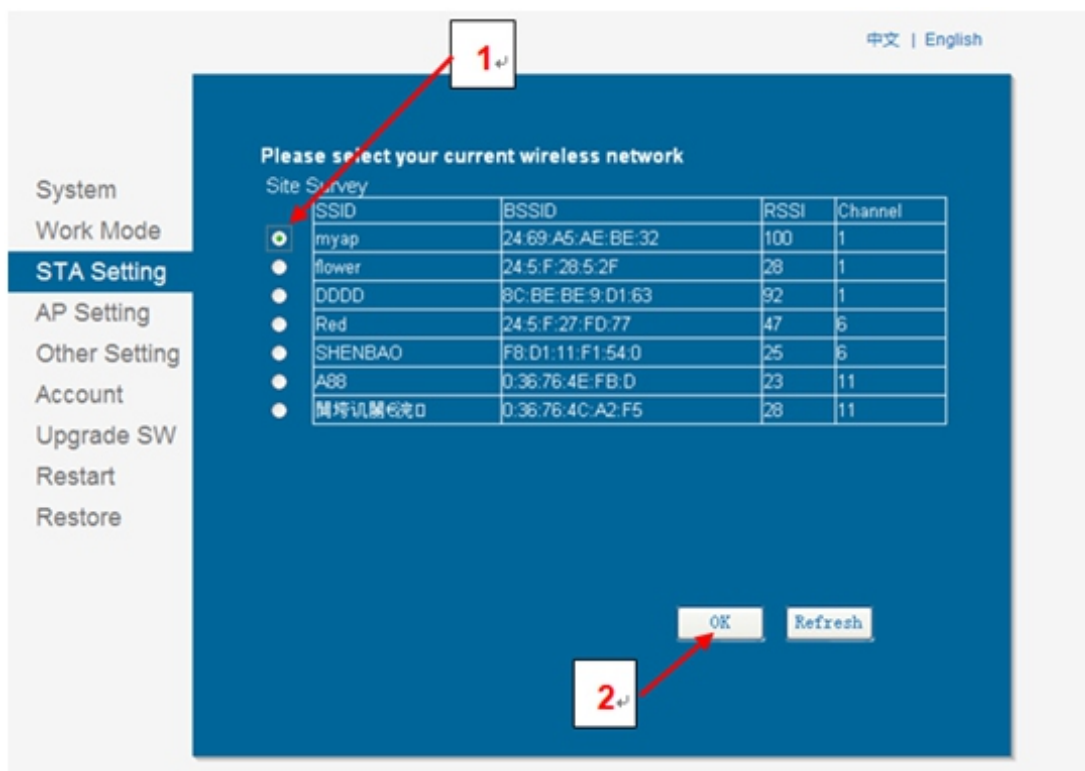

# SWIMMING POOL HEAT PUMP

## b. Second way for wifi setting

- ◎ Make sure the Encryption Method choose **WPA2PSK**, and Encryption Algorithm choose **AES**. Input the **password** of your local area network. Then press **Save**.

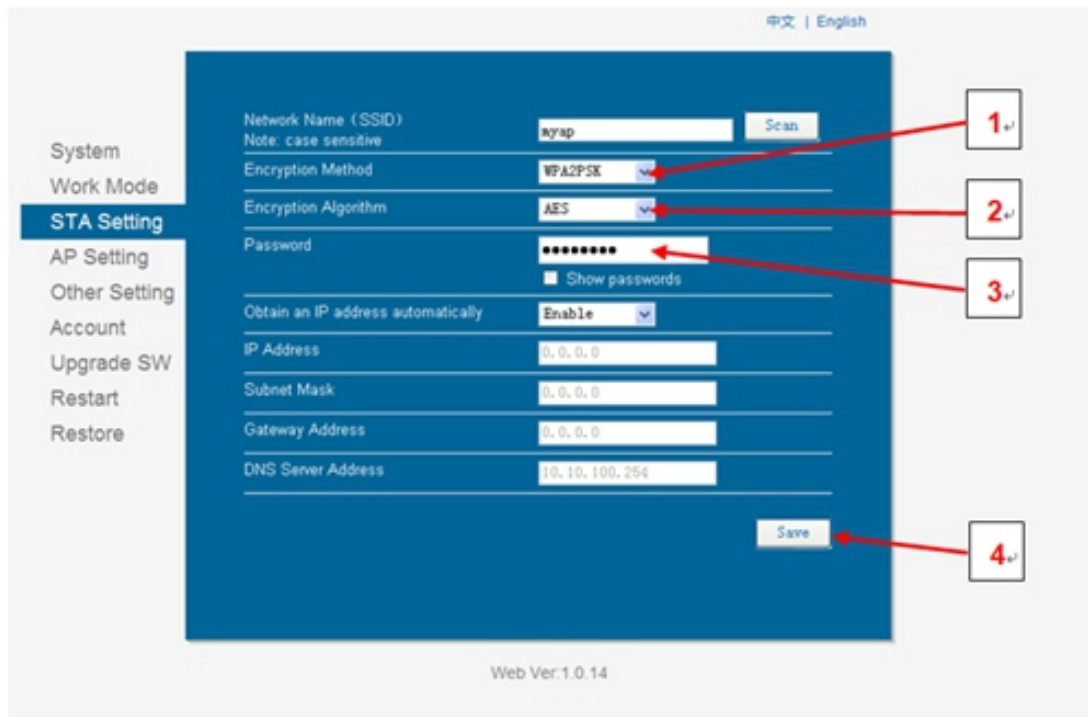

- ◎ After finished all above steps, come to Restart interface, and press OK to confirm RESTART. See below pic.

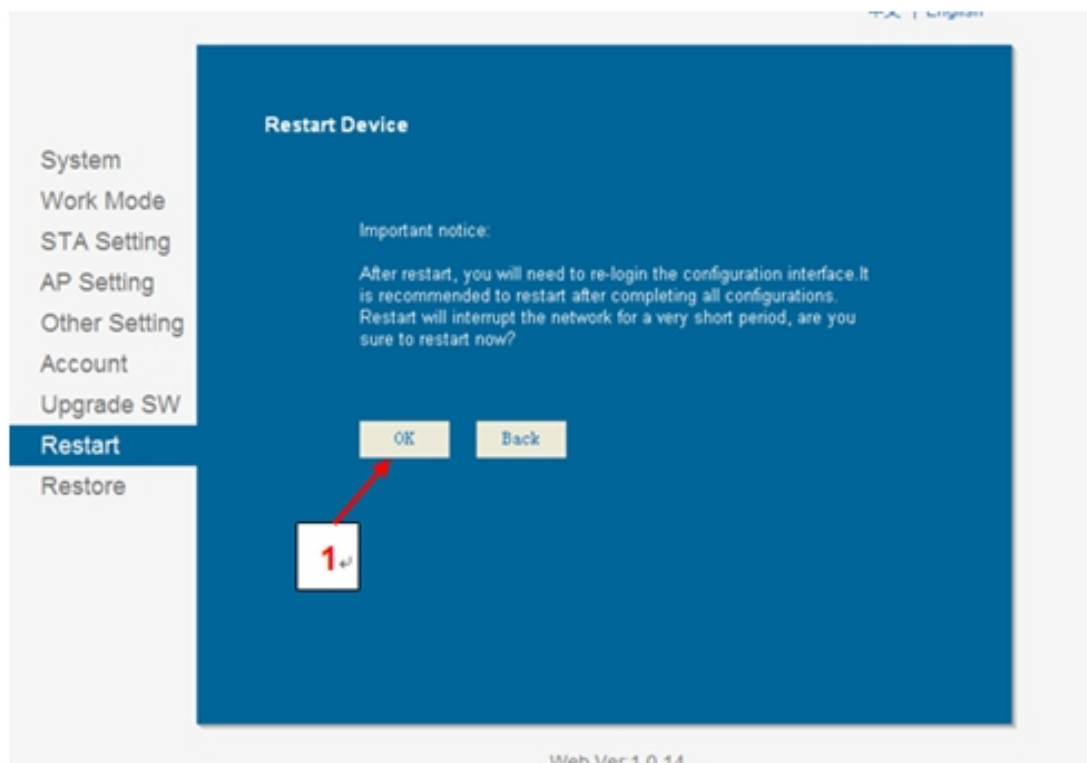



# ***SWIMMING POOL HEAT PUMP***

---

## **c. Remarks**

- Make sure to press “SAVE” for each setting.
- If IP address changed, all above setting need to re-set.
- If you try first way of “Smartlink3 DOMO” and failed, then try the second way for wifi setting.  
Have to long press Turn on/off button (see below pic) for 10 seconds, otherwise, wifi signal will never come out.



**Turn on/off button**

## **d. Fast Inquiry**

- After wifi connected successful, you could have inquire about heat pump status by below website. <http://app.xlink.cn:9001/query.html>  
Or you could scan below QR Code to enter the website for Heat pump status checking.  
Fast inquire (only to check 1 or 2 heat pump units)



- Agent research (Able to check all the heat pumps as order). Or visit below website.  
<http://app.xlink.cn:9001/login.html>



## ***SWIMMING POOL HEAT PUMP***

---

### **4. Maintenance**

- **To check the water supply device often. You should avoid the condition of no water or air entering into system, or that will influence unit's performance and reliability. You should clear the water filter regularly to avoid unit's damage by filter' jam.**
- **There should be dry, sanitary and ventilation around the unit. To clean the side condenser regularly for good heating exchanging and saving energy.**
- **To check the power supply and cable connection often, to see if there is abnormal action or bad smell about the electrical component. If yes, Contact Installer immediately.**
- **Please discharge all water in the water pump and water system lest freeze the water pump or water system. You should discharge the water at the bottom of water pump if the units will stop for long time. And you should check the units thoroughly and fill the system with water fully before power on the units again.**

# SWIMMING POOL HEAT PUMP

## 5. Wiring diagram

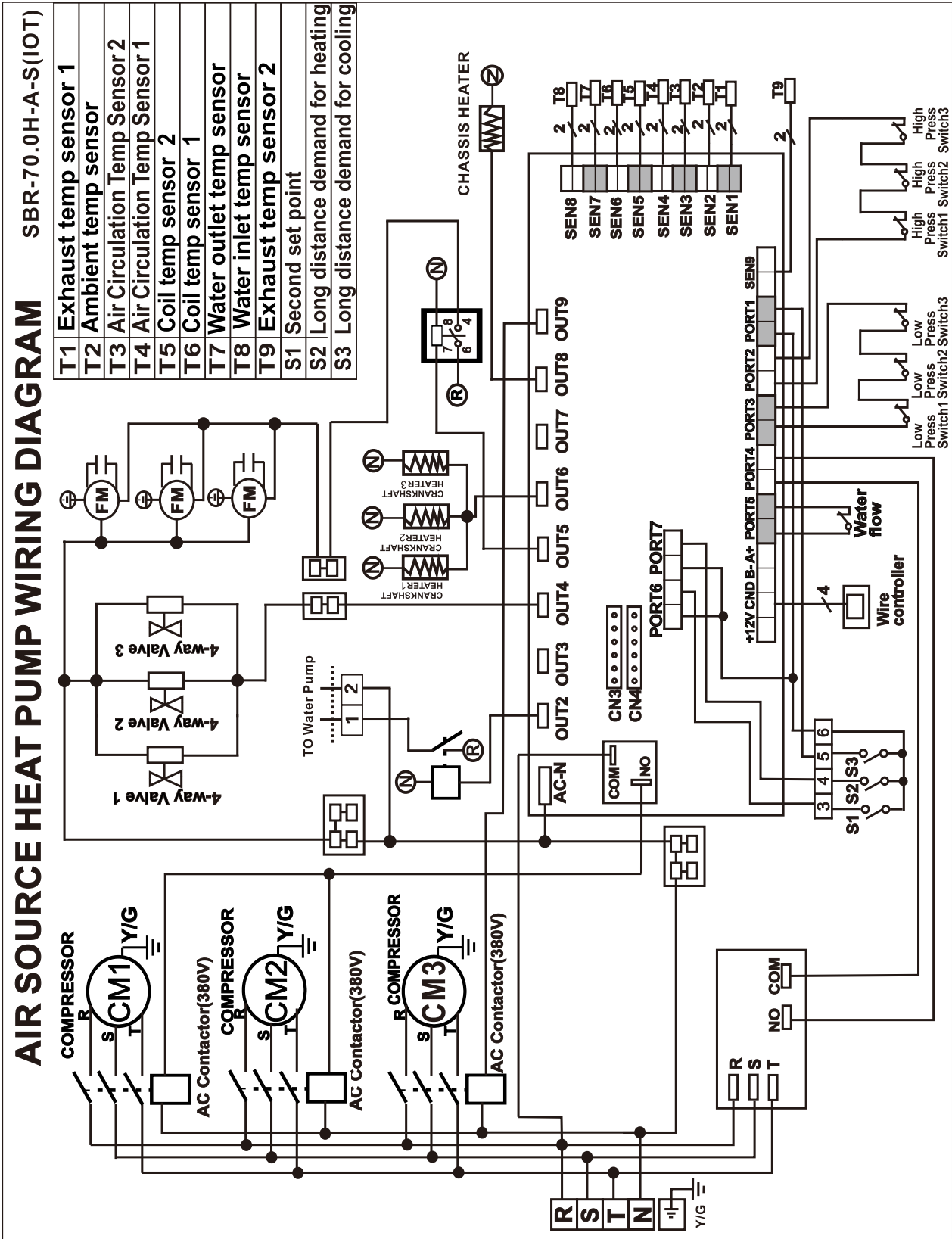

# ***SWIMMING POOL HEAT PUMP***

---

## **Service**

### **1. How to obtain Service For Pool Owner**

If you are having trouble with the unit, please contact the Installer immediately.

1. Provide your Dealer with the following information:

- A. Serial # located on back panel nameplate .
- B. Proof of Installation Date (Bill of sale or original invoice only)
- C. Description of the Symptoms

### **2. For Installing Dealer**

If your customer is having a problem and you as the installing dealer have verified that the cause is NOT external to my company (such as tripped breaker, clogged pool filter, inadequate pump run time, etc.) following these steps will help you obtain the fastest service possible for your customer.

1. Help your customer gather the following information:

- A. Serial # located on back panel nameplate .
- B. Proof of Installation Date (Bill of sale or original invoice only)

### **3. Will Ever Need Freon**

Unless there is a leak in the sealed refrigeration system, the factory charge of freon should last for the life of the unit. Freon is very stable and should not degrade or breakdown even under severe operating conditions. If your unit needs freon, then it has a leak, and adding freon will not solve the problem. The leak must be located and repaired. Fortunately, freon leaks are very uncommon and usually are due to shipping.

## **Attachment 1**

### **SWIMMING POOL HEATING SYSTEM EVALUATION**

#### **1. The charts displayed for an outdoor pool**

Energy flows in a heated pool

Energy flows in an unheated pool

Pool temperature

Range of pool temperature (max exceeded for 5% of the time and mini temperature exceed for 95% of the time.)

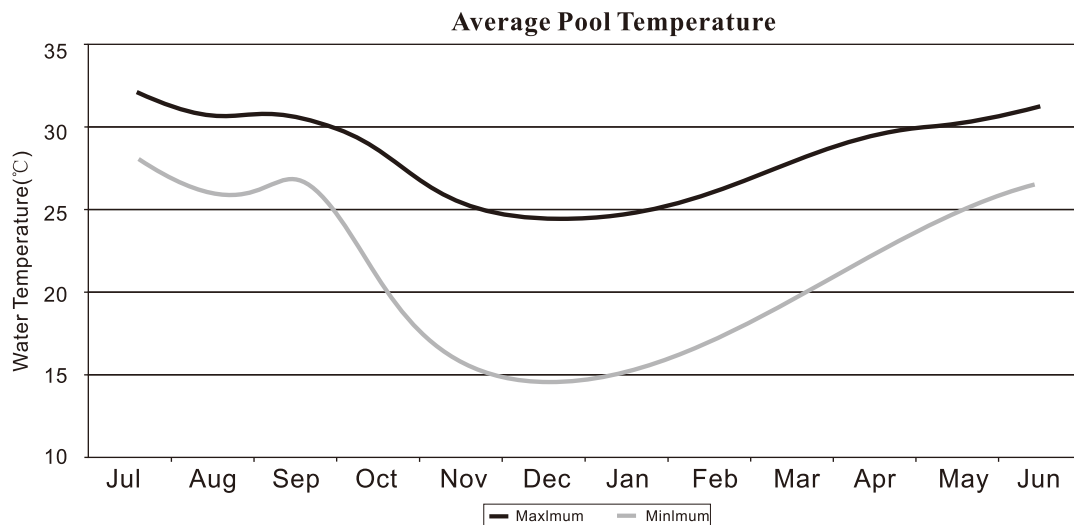

# ***SWIMMING POOL HEAT PUMP***

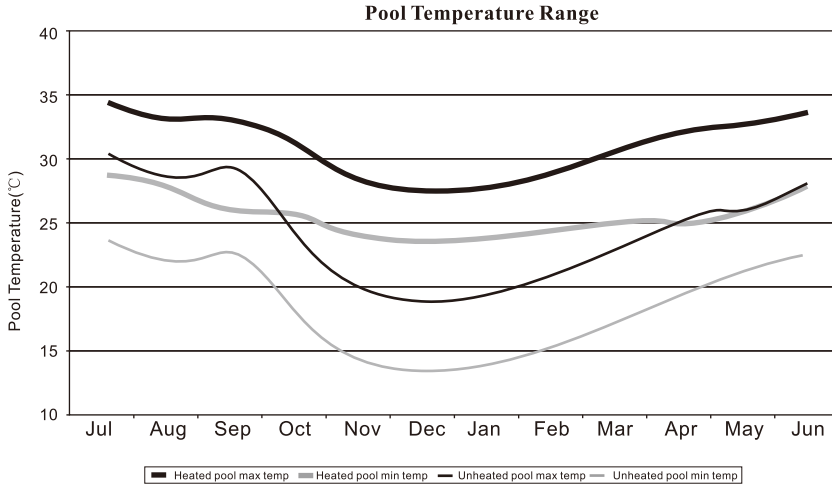

## **2. The charts displayed for an indoor pool are**

**Energy flows for indoor pool.**

**Pool temperature during daytime operating period.**

**Space temperature during daytime operating period.**

**Space humidity during daytime operating period.**

**Pool temperature at night.**

**Space temperature at night.**

**Space humidity at night.**

**Some of the charts are.**

**Pool Temperature operating period**

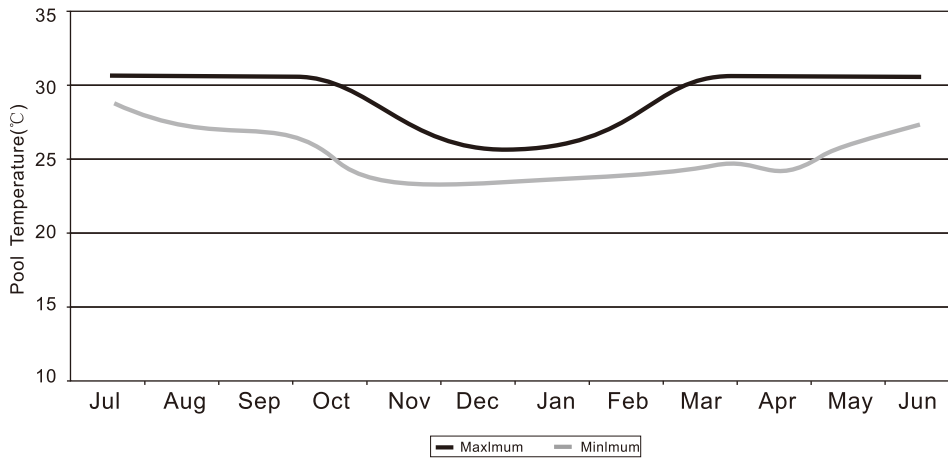

**Space Temperature operating period**

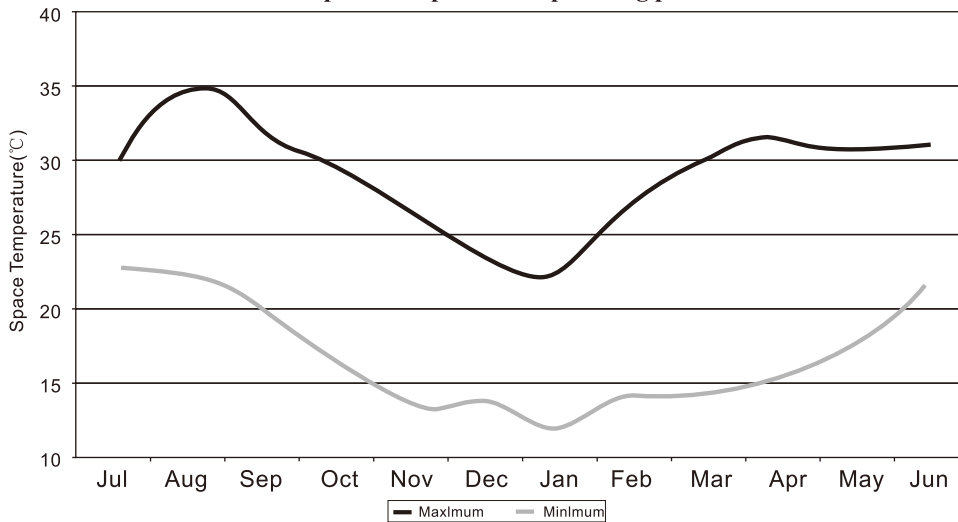

# SWIMMING POOL HEAT PUMP

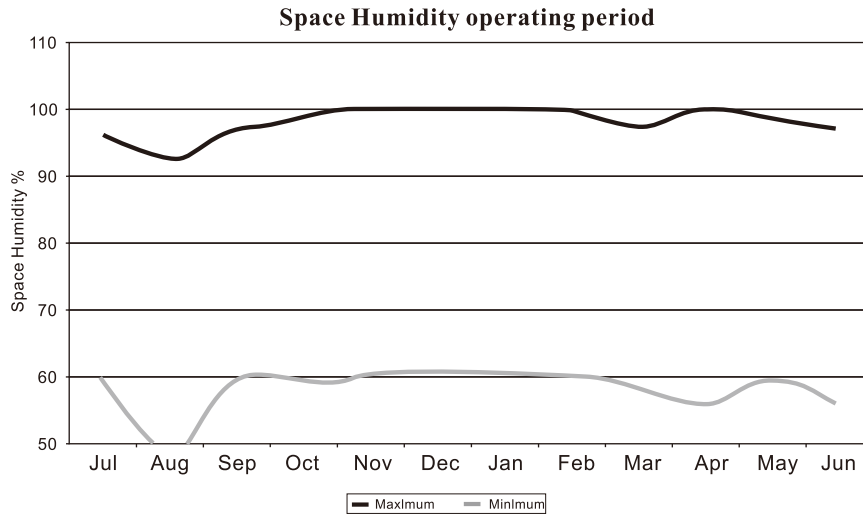

## The position of installing unit

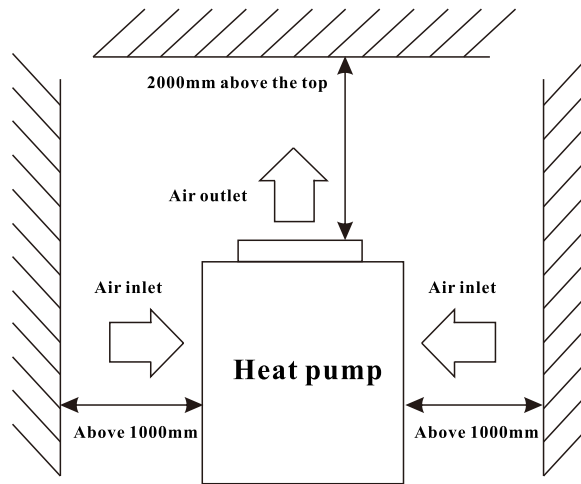

## Attachment 2

### The Installation about Heat Pump & Chlorinator

#### Pressure-type Chlorinator or Brominator

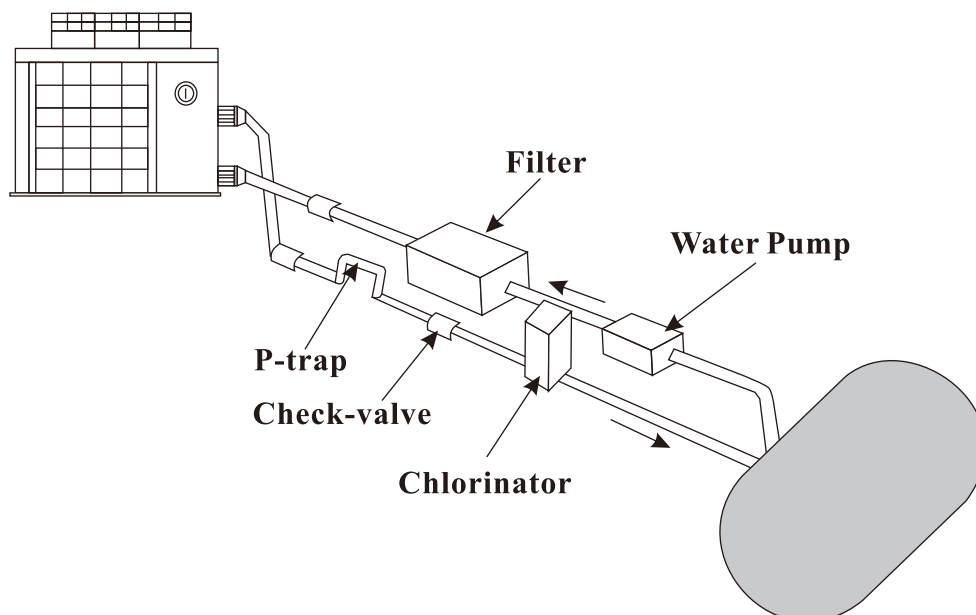

# ***SWIMMING POOL HEAT PUMP***

---

## **Attachment 3**

### **Common Units Conversion**

#### **Linear Measure**

1 inch=25.4 millimetres  
1 foot=12 inches=0.3048 metre  
1 yard=3 feet=0.9144 metre  
1 (statute)mile=1760 yards=1.609 kilometres  
1 nautical mile=1852 m.

#### **Square Measure**

1 square inch=6.45 sq.centimetres  
1 square foot=144 sq.in.=9.29 sq.decimetres  
1 square yard=9 sq.ft.=0.836 sq.metre  
1 acre=4840 sq.yd.=0.405 hectare  
1 square mile=640 acres=259 hectares

#### **Cubic Measure**

1 cubic inch=16.4 cu.centimetres  
1 cubic foot=1728 cu.in.=0.0283 cu.metre  
1 cubic yard=27 cu.ft.=0.765 cu.metre

#### **Capacity Measure**

##### **British**

1 pint 20 fluid oz.=34.68 cu.in.=0.568 litre  
1 quart=2 pints=1.136 litres  
1 gallon=4 quart=4.546 litres  
1 peck=2 gallons=9.092 litres  
1 bushel=4 pecks=36.4 litres  
1 quarter=8 bushels=2.91 hectolitres

##### **American dry**

1 pint=33.60 cu.in.=0.550 litre  
1 quart=2 pints=1.101 litres  
1 peck=8 quarts=8.81 litres  
1 bushel=4 pecks=35.3 litres

##### **American liquid**

1 pint=16 fluid oz.=28.88 cu.in.=0.473 litre  
1 quart=2 pints=0.946 litre  
1 gallon=4 quarts=3.785 litres

#### **Avoirdupois Weight**

1 grain=0.065 gram  
1 dram=1.772 grams  
1 ounce=16 drams=28.35 grams  
1 pound=16 ounces=7000 grains=0.4536 kilogram  
1 stone=14 pounds=6.35 kilograms  
1 quarter= 2 stones=12.70 kilograms  
1 hundredweight=4 quarters=50.80 kilograms  
1 short ton=2000 pounds=0.907 tonne  
1 (long)ton=20 hundredweight=1.016 tonnes

#### **energy, power**

1 usrt=3024 kcal/h=3516 w  
1 kcal/h=1.163 w  
1 kw=860 kcal/h  
1 btu/h=0.293 w

#### **velocity, flux**

1 m/s=196.85 fpm  
1 cfm=1.699 cmh  
1 gpm=0.27276 cmh  
1 gpm=0.2271 cmh

#### **Pressure**

1 bar=100000 pa  
1 psi=0.0703 kgf/cm<sup>2</sup>  
1 kgf/cm<sup>2</sup>=98000 pa  
1 mm aq.=9.8 pa  
1 mm hg=133.28 pa  
1 m H<sub>2</sub>O=9800 pa=0.1 kgf/cm<sup>2</sup>

