

SWIMMING POOL

HEAT PUMP UNIT

Installation & Instruction Manual

— English Version —

SWIMMING POOL HEAT PUMP

Contents

Performance Data Specifications

1.Performance data of Swimming Pool Heat Pump Unit -----	1
2.The dimension for Swimming Pool Heat Pump --- -----	2
3.Wire controller operation guide-----	3
4.Maintenance-----	7
5.Malfunction and solution -----	7
6.Wiring diagram-----	9

Service

1.How to Obtain Service-----	11
-------------------------------------	-----------

Attachment

1.The charts displayed for outdoor pool & indoor pool -----	11
2.The Installation about Heat Pump & Chlorinator-----	14
3.Common Units Conversion-----	16

Dear customers:

In order to use this machine safely, please read this user's manual carefully before using and installation, especially pay attention to each notice remark for usage and maintenance. Also keep it carefully for later use. Heat pump water heater is a professional machine, it may cause damage or hazard when wrong installed. Relevant installation and maintenance shall be done by technical people. Please contact our installation service for reference.

 Important warning:

- 1). This appliance can be used by children aged from 8 years and above and persons with reduced physical, sensory or mental capabilities or lack of experience and knowledge if they have been given supervision or instruction concerning use of the appliance in a safe way and understand the hazards involved. Children shall not play with the appliance. Cleaning and user maintenance shall not be made by children without supervision.
- 2). Children should be supervised to ensure that they do not play with the appliance.
- 3). The specifications of fuse is: AC250V, 5A.
- 4). The appliance must be fitted with means for disconnection from the supply mains having a contact separation in all poles that provide full disconnection under overvoltage category III conditions and these means must be incorporated in the fixed wiring in accordance with the wiring rules. Please make sure that the unit and power connection have good earthing, otherwise may cause electrical shock..
- 5). The running range of the heat pump:
 1. Heating : outlet water range: 15 ~ 35°C, the ambient temperature range 0 ~ 32°C;
 2. Cooling : outlet water range: 8 ~ 30°C, the ambient temperature range 20 ~ 43°C;
 3. the pressure of water : 14 ~ 18kpa

SWIMMING POOL HEAT PUMP

1. Performance data of Swimming Pool for A type

Model		SBR-26.0H-B-S	SBR-50.0H-A-S
Rated Heating Capacity	W	26000	50000
	BTU/h	90000	170000
Rated Cooling Capacity	W	18200	36000
	BTU/h	62000	125000
Heating Range		15~40	
Cooling Range		8~30	
Heating Input Power	W	5650	11100
Cooling Input Power	W	5510	11250
Running Current Heating	A	8.9×3	17.6×3
Running Current Cooling	A	8.7×3	17.8×3
COP	W/W	4.6	4.7
EER	W/W	3.3	3.2
Power Supply	V/PH/Hz	380/3/50	
Compressor Type		Scroll	
Compressor Nos.		1	2
Fan Motor Nos.		2	2
Fan Motor Input	W	90×2	150×2
Fan Speed	RPM	890	830
Noise	dB(A)	60	63
Water Connections	inch	1-1/2"	2"
Water Flow Volume	m ³ /h	6-10	8-15
Water Pressure Drop	Kpa	16	18
Unit Dimension	L	mm	1115
	W		470
	H		1250
Packing Dimension	L	mm	1220
	W		480
	H		1380
Weight	Net Weight	kg	126
	Gross Weight		145
			235
			265

Measurement conditions:

outdoor air temp:24℃/19℃, inlet water temp:27℃

SWIMMING POOL HEAT PUMP

2. The dimension for Swimming Pool Heat Pump

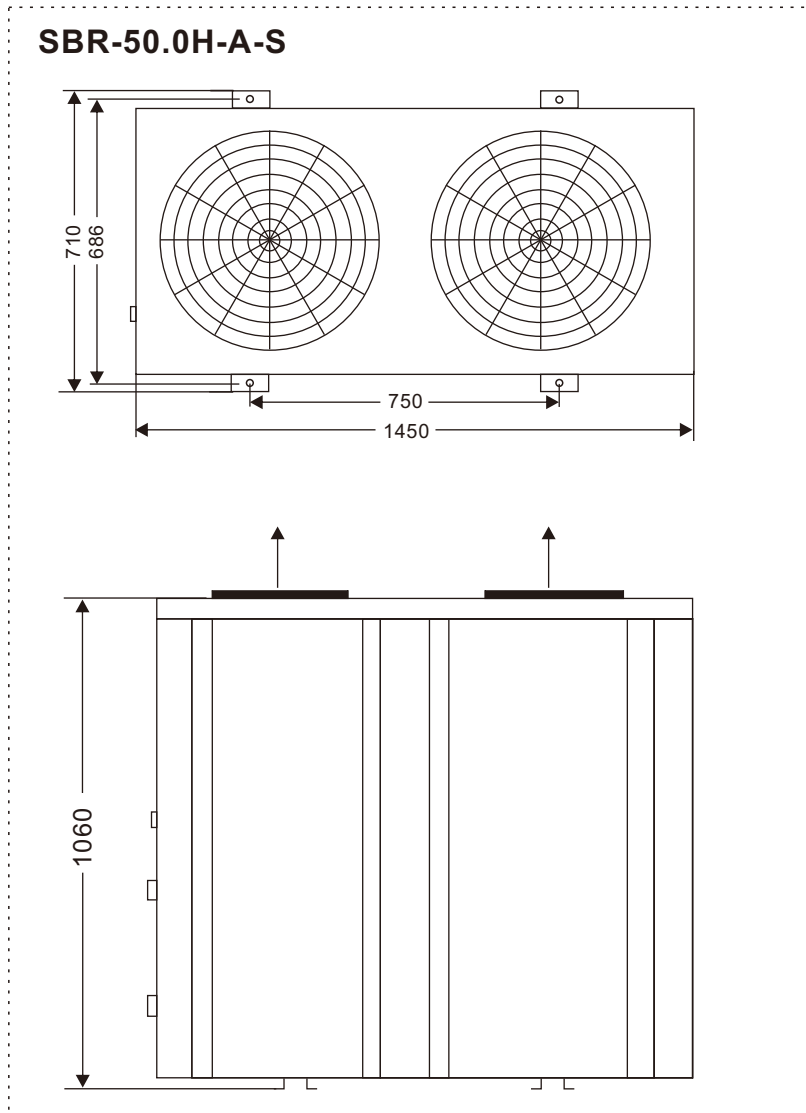
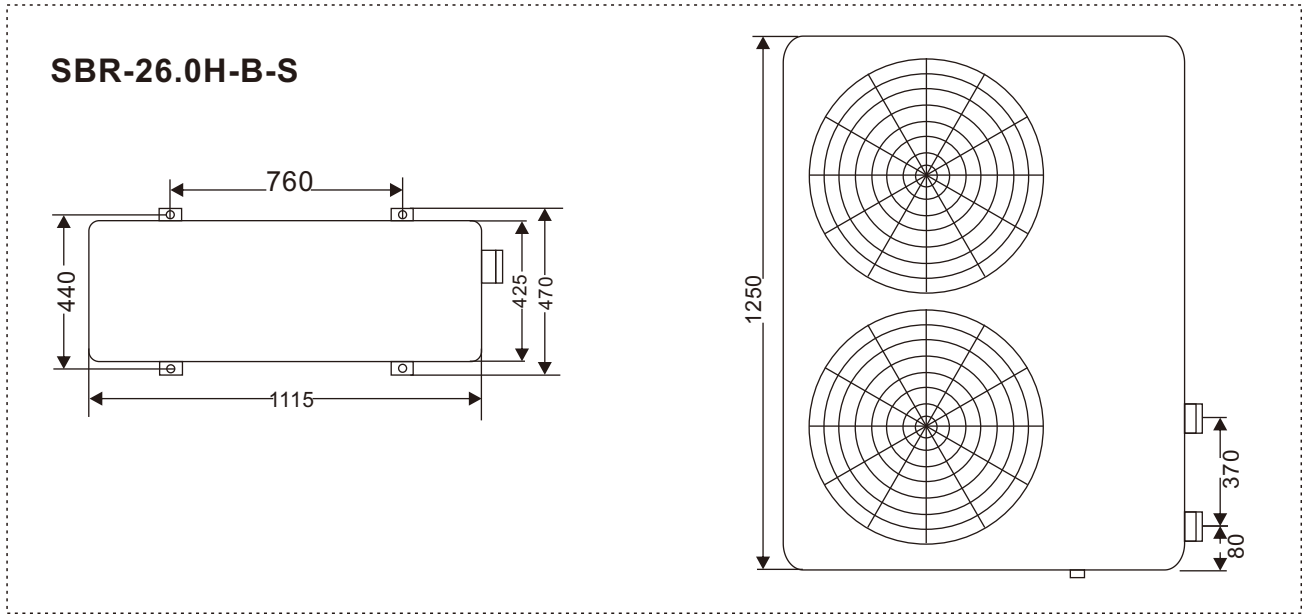

SWIMMING POOL HEAT PUMP

3. Wire controller operation guide

The functions of the wire controller

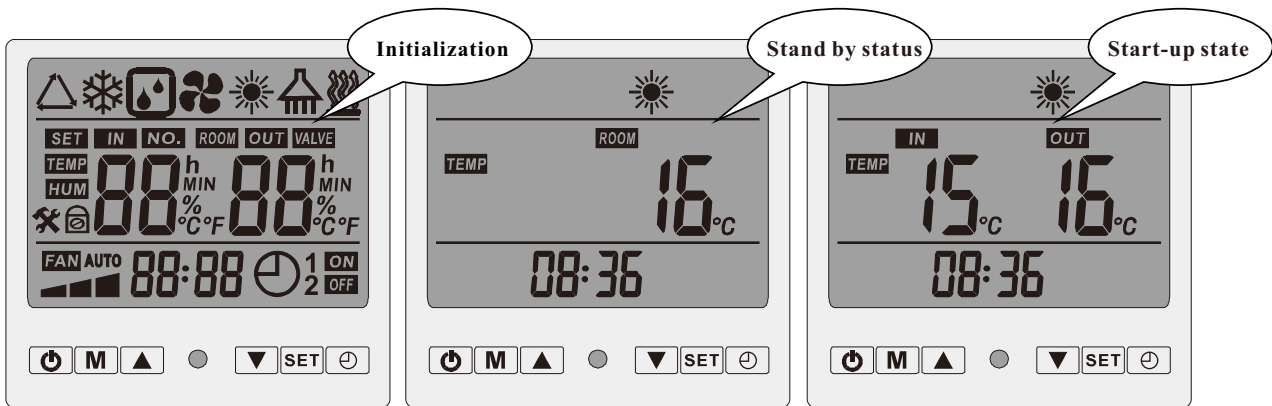

Remarks: Standby status means the unit is connected with electricity but not running.

1) Wire Controller Button Definition

◎ "⏻" Button-----To turn on or turn off your heat pump

You may turn on or turn off the heat pump in any state.

◎ "M" button-----Button for different mode

Press this button to switch the working mode. Continuously press this button , the modes circularly switches as follow.

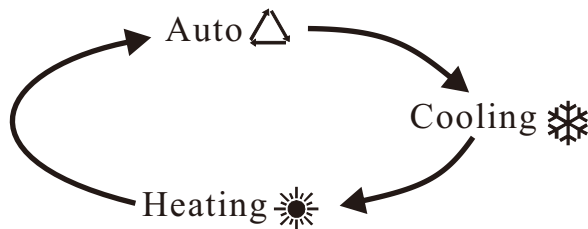

Remark: water cooler (0)with cooling mode only

water heater (3)with heating mode only

water cooler and heater(1)and electric heater(2) with auto, cooling , heating , 3 modes.

◎ "▲" button and "▼" button-----Up and down button

Integrating with "SET" button to check or change each data value.

◎ "SET" button-----Button for setting

Integrating with "▲" button and "▼" button to check or change each data value.

◎ "⌚" button-----Button for timing

Integrating with "▲" and "▼" button, to set the time for turning on or turning off the heat pump .

If you choose the model with electric heater,press this button may start or shut off the electric heater.

SWIMMING POOL HEAT PUMP

2) Wire Controller Operation

◎ Check the working status

In the state of OFF, LCD display ambient temperature , In th state of ON, LCD display water in temperature and water out temperature ; In the default state, press " ▲ " or " ▼ " once, may check P1、 P2 and ROOM states; In the checking mode, if not pressing any buttons in 5 seconds, system will auto exit the checking mode and return to default state.

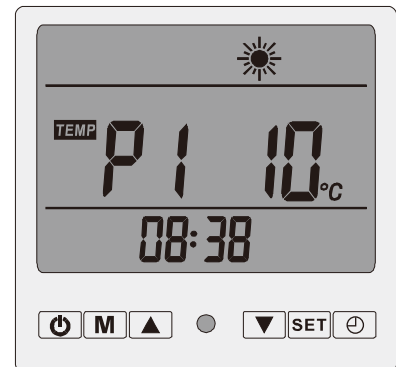

State	State content	Range	Remark
IN	Water inlet temperature	-9°C ~99°C	Actual tested value
OUT	Water outlet temperature	-9°C ~99°C	Actual tested value
P1	Coil 1 temperature	-9°C ~99°C	Actual tested value
P2	Coil 2 temperature	-9°C ~99°C	Preservation
ROOM	Ambient temperature	-9°C ~99°C	Actual tested value

◎ Parameter checking and Setting

You may enter parameter checking state from any other states by pressing " SET " once. In the state of Parameter Checking, each press on " SET " can check the next data(circularly checking), from 0 to c totally 13 parameter' status.

Parameter 0 and Value 1 on Parameter Checking State, you can directly press " ▲ " or " ▼ " for setting.

In the state of Parameter Checking , press AT THE SAME TIME " ▲ " AND " ▼ " for 3 seconds, vibrator "dee" for once to enter other parameter setting ,at this moment , press " ▲ " or " ▼ " may set each parameter, press " SET " to check different parameter.

In the state of Parameter Checking or Parameter Setting, if not pressing any button within 5 seconds, the system will exit Parameter Checking or Setting State and return to the default state.

(parameter from 0-C, see the Operation Parameter Table)

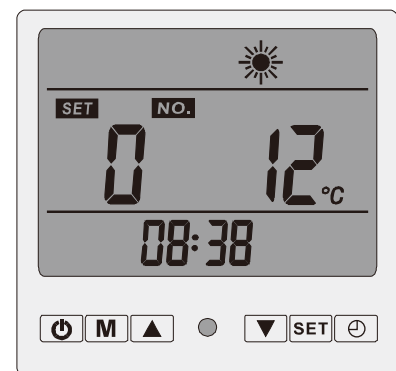

SWIMMING POOL HEAT PUMP

The unit's operation data can be set on the wire controller.

Please set according to below table:

Digit	meaning	Range	Default	Adjust(yes/no)
0	Return water temp. Setting(cooling mode)	8-28℃	12℃	yes
1	Return water temp Setting(heating mode)	15-40℃	27℃	yes
2	Total working time of compressor after frosting	30-90MIN	40MIN	Adjusted by technicians
3	Setting initialization temp for defrosting	0--30℃	-7℃	Adjusted by technicians
4	Temperature of exit defrost under heating model	2-30℃	13℃	Adjusted by technicians
5	Time of exit defrost under heating model	1-12MIN	8MIN	Adjusted by technicians
6	System quantity	1-2	1	Adjusted by technicians
7	Automatic restarting	0-1	1(have recording)	Adjusted by technicians
8	Model(cooling only/heating or cooling/ auxiliary electrical heating /hot water)	0-3	1(heating or cooling)	Adjusted by technicians
9	Working mode of water pump 0: water pump automatically turns off after compressor stop for 30s. 1: water pump keep running even set point temp reached and heat pump in stand by mode.	0-1	0	Adjusted by technicians
A	Auto mode(return water temp)	8-40℃	30℃	Adjusted by technicians
B	Return temp. Setting	1-5℃	2℃	Adjusted by technicians
C	Outlet water offset temperature	1-10℃	0℃	Adjusted by technicians

◎ Real Time Clock Setting

In the default state, long press " **SET** " for 3 seconds to enter Real Time Clock Setting State;

In the state of Real Time Clock Setting, press " **SET** " once again, hour numbers flash, press " **▲** " or " **▼** ", can adjust the hour for the clock.

After the clock hour is setted, press " **SET** " once again, minute numbers flash, press " **▲** " or " **▼** ", can adjust the minute for the clock.

After setting the clock minute, press " **SET** " again to confirm the clock setting and return default state.

In the state of Real Time Clock Setting, if not pressing any button within 5 seconds, the system will confirm the clock setting and return to default state.

In the state of Real Time Clock Setting, press " **⏻** " once, confirm current setting value for clock, return to default state and change the ON/OFF state.

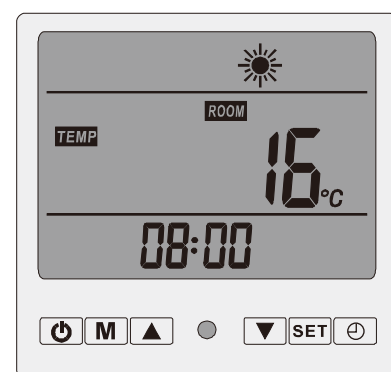

SWIMMING POOL HEAT PUMP

◎ Timming ON /OFF Setting

In default state, long press "☰" for 3 seconds to enter Timing Setting state. In the state of Timming Setting, press "☰" again, the hour numbers for timing ON flash, press "▲" or "▼" to adjust the hour for timing ON setting.

After setting the hour for timing ON, press "☰" once again, the minute number for timing ON flash, press "▲" or "▼" to adjust the minute for timing ON.

After setting the minute for timing ON, press "☰" once again, to enter the hour setting of timing OFF; After setting the timing OFF hour and minute, press "☰" again, to confirm current setting and return to default state. In the state of Timming Setting, press "SET" once, it will clear timing ON /OFF setting and return to default state. In the state of Timming Setting, if not pressing any button within 5 seconds, it will auto confirm the current timing setting and return to default state. In the state of Timming Setting, press "☑" once, it will confirm the current timing setting and return to default state and change the ON /OFF state.

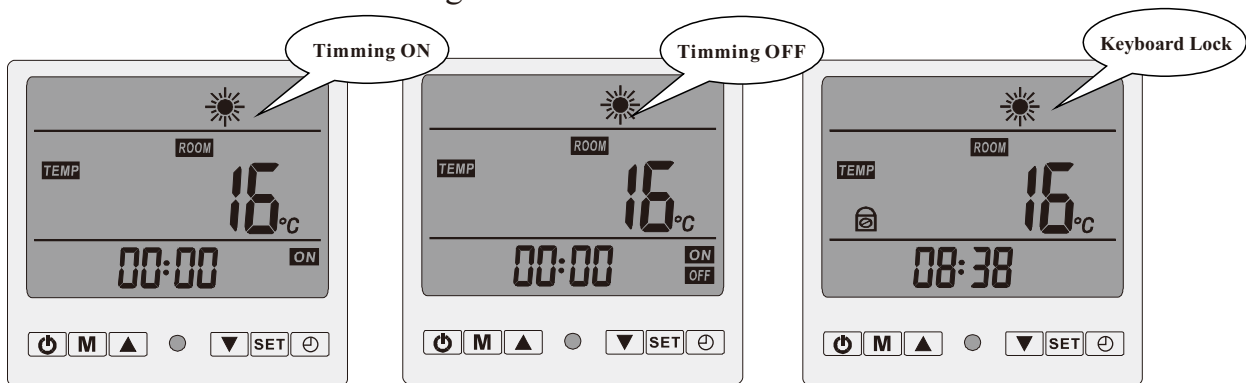

◎ Keyboard Lock & Unlock

In default state, long press "▲" and "▼" for 3 seconds AT THE SAME TIME, vibrator "bee" once, the keyboard will be locked. In the state of Locked, long press "▲" and "▼" for 3 seconds, vibrator "bee" for once, the keyboard will be unlocked.

◎ Back Up Memory After Power Resumption

When the heat pump is working in normal state and electricity power cut off suddenly, the system will run in the last setting record after power resumption.

◎ Setting about S1 & S2 switch

S1 Switch---Long distance demand for heating

S2 Switch---Long distance demand for cooling

Please refer to the wiring diagram for the location of S1 and S2 switch.

- 1) Heat pump turns on when S1 or S2 switch has well connected. While S1 or S2 has connected, suddenly press the off button on the LCD controller. Heat pump will stop for 3 minutes. However, heat pump continues to turn on if S1 or S2 still has been connected after 3 minutes.
- 2) The Timer function is out of validity either S1 or S2 switch has connected.
- 3) Heat pump turns off when S1 or S2 switch is disconnected. Meanwhile, need to use LCD controller to turn on /off the heat pump.

SWIMMING POOL HEAT PUMP

4. Maintenance

- To check the water supply device often. You should avoid the condition of no water or air entering into system, or that will influence unit's performance and reliability. You should clear the water filter regularly to avoid unit's damage by filter' jam.
- There should be dry, sanitary and ventilation around the unit. To clean the side condenser regularly for good heating exchanging and saving energy.
- To check the power supply and cable connection often, to see if there is abnormal action or bad smell about the electrical component. If yes, Contact Installer immediately.
- Please discharge all water in the water pump and water system lest freeze the water pump or water system. You should discharge the water at the bottom of water pump if the units will stop for long time. And you should check the units thoroughly and fill the system with water fully before power on the units again.

5. Malfunction and solution

Malfunction	Wire Controller display	Reason	Solution
Water in temp Sensor failure	PP 01	The sensor is open or short circuit	Check or change the sensor
Water out temp Sensor failure	PP 02	The sensor is open or short circuit	Check or change the sensor
Coil1 sensor failure	PP 03	The sensor is open or short circuit	Check or change the sensor
Coil2 sensor failure (proprietary for A type)	PP 04	The sensor is open or short circuit	Check or change the sensor
ambient sensor failure	PP 05	The sensor is open or short circuit	Check or change the sensor
Temp is too much different between water-in and water-out	PP 06	Water flow volume not enough, water pressure difference is too low	Check the water flow volume, or water system is jammed or not
Anti freezing under cooling mode	PP 07	Water flow volume is not enough	Check the water flow volume, or water system is jammed or not
The first time freezing protection in winter	PP 08	Too low	
The second time freezing protection in winter	PP 09	Too low	
Malfunction of system1 (for 3 phase model)	EE 01	The system1 protection was failure	Check each protection point of system1 remove the malfunction according to System Protection Board malfunction table (See protect 300 page 10)
High/Low pressure protection (for single phase model)		System gas pressure too high or too low	Check refrigerant pressure
Malfunction of system2	EE 02	The system2 protection was failure	Check each protection point of system2 remove the malfunction according to System Protection Board malfunction table (See protect 300 page 10)
Flow switch failure	EE 03	No water/little water in water system.	Check the water flow volume, water pump is failure or not.
Power supply connections wrong (for 3phase unit).	EE 04	Wrong connections or lack of connection	Check connections of power cable.
3 times water-in and water-out temp difference protection in 30minutes	EE 05	Water flow volume not enough, water pressure difference is too low	Check the water flow volume, or water system is jammed or not.
Compressor air exhaust protection	EE06	Compressor air exhaust temperature too high	Check water flow and gas pressure
defrosting	Defrost code display		
Communication failure	EE 08	Wire controller and The PCB connection failure.	Check the wire connection

SWIMMING POOL HEAT PUMP

Connection of PCB illustration

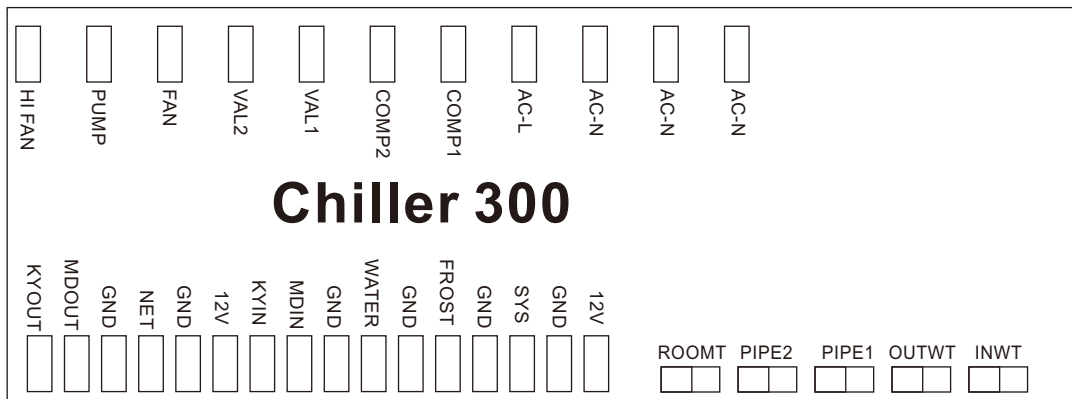

Connections explanation:

NO .	Symbol	Meaning
1	HI FAN	High speed for fan
2	PUMP	Water pump(220VAC)
3	FAN	Fan motor(220VAC)
4	VAL2	4way valve of system2(220VAC)(no use)
5	VAL1	4way valve of system(220VAC)
6	COMP2	Compressor of system2 (220VAC)(no use)
7	COMP1	Compressor of system1 (220VAC)
8	AC-L	Live wire
9	AC-N	neutral wire
10	KYOUT GND	On/Off switch (output)(no use)
11	kDOUT GND	Mode output (no use)
12	NET GND 12V	Wire controller
13	KYIN	On/Off Switch(input)(no use)
14	MDIN	Model (input) (no use)
15	WATER GND	Flow switch (input)(+normal close)
16	FROST GND	Defrost signal(no use)
17	SYS GND 12V	System protection(input)(normal close)
18	ROOMT	Ambient temp.(input)
19	PIPE2	Temp. Of fan coil2(input)(no use)
20	PIPE1	Temp. Of fan coil1(input)(no use for split type)
21	OUTWT	Water out temp.(input)
22	INTWT	Water in temp. (Input)

SWIMMING POOL HEAT PUMP

Error code	Protection
1	Refrigerant anti-freezing protection(Not available for the moment)
2	Refrigerant leakage protection(Not available for the moment)
3	Refrigerant low pressure protection
4	Gas compressing side high temperature protection
5	Compressor over-current protection
6	Refrigerant high pressure protection
7	System refrigerant inlet pipe sensor protection(Not available for the moment)
8	System refrigerant outlet pipe sensor protection(Not available for the moment)
9	Gas compressing side temperature sensor protection
EE	Power source phase protection

Description for protection function :

1. Refrigerant anti-freezing protection(Not available for the moment)
2. Refrigerant leakage protection(Not available for the moment)
3. Refrigerant low pressure protection:
After compressor start 3 minutes later, system continuously detect 10 seconds for the low pressure switch, if the low pressure switch is opened, system enter to low pressure protection (error code 3) , when detected low pressure switch is closed, system exit the low pressure protection .
4. Gas compressing side high temperature protection :
After compressor start 5 minutes later, system continuously detect 5 seconds for gas compressing side, if gas compressing side temperature $T_3 \geq 120^\circ \text{ C}$, system enter to gas compressing side air exhausting high temperature protection(error code 4) , when detected gas compressing side air exhausting tempertaure $T_3 \leq 90^\circ \text{ C}$, system exit the gas compressor side high temperature protection.
Remark 1 : P1, P2, P4 protection only valid when relevant system compressor is on, If relevant system compressor is off, even the temperature point is reached, protection is not valid. The on or off of the compressor is detected by compressor current (0 or not)
5. Compressor over-current protection:
System continuously detect 3 seconds for compressor phase 1 (or 2) , If phase 1 (or 2) current ≥ 1 , system enter to compressor over-current protection(error code 5). When detected compressor phase 1 (or 2) current ≤ 1 , system exit the protection of compressor over-current.
6. Gas compressing side high temperature protection:
When system continuously detects 10 seconds for the relevant system high pressure switch, and if high pressure switch is opened , system enter to high pressure protection(error code: 6) when detected the high pressure switch closed, system exit the protection of high pressure.
7. System refrigerant inlet pipe sensor protection(Not available for the moment)
8. System refrigerant outlet pipe sensor protection(Not available for the moment)
9. Gas compressing side temperature sensor protection
When system continuously detect 5 seconds for the relevant system compressor air exhaust temperature sensor to be short cuted or opened, system enter to gas compressing side temperature sensor protection (error code 9) , otherwise system exit the protection .(sensor open or not is detected only after relevant compressor run 1 minutes later)
10. Power source phase protection (Not valide durning heat pump running)
Within 10 seconds after heat pump is connected to power source, system detect continuously 2 seconds for the system phase , if wrong phase or lack phase, system enter to power source phase protection (error code EE). When this protection is activated, system can not return to normal unless re-connecting to power source.
Remark 2 : system high pressure protection E6, low pressure protection E3, over-current protection E5, gas compressor side air exhausting protection E4 , all are serious system malfunction , if any system appear continuously 3 times for such serious malfunction within 30 minutes, system can not return to normal unless re-connecting to power source . During defrosting period, system high/low pressure protection is not valid.

SWIMMING POOL HEAT PUMP

Service

1. How to obtain Service For Pool Owner

If you are having trouble with the unit, please contact the Installer immediately.

1. Provide your Dealer with the following information:

- A. Serial # located on back panel nameplate .
- B. Proof of Installation Date(Bill of sale or original invoice only)
- C. Description of the Symptoms

2. For Installing Dealer

If your customer is having a problem and you as the installing dealer have verified that the cause is NOT external to my company(such as tripped breaker, clogged pool filter, inadequate pump run time, etc.) following these steps will help you obtain the fastest service possible for your customer.

1. Help your customer gather the following information:

- A. Serial # located on back panel nameplate .
- B. Proof of Installation Date(Bill of sale or original invoice only)

3. Will Ever Need Freon

Unless there is a leak in the sealed refrigeration system, the factory charge of freon should last for the life of the unit. Freon is very stable and should not degrade or breakdown even under severe operating conditions. If your unit needs freon, then it has a leak, and adding freon will not solve the problem. The leak must be located and repaired. Fortunately, freon leaks are very uncommon and usually are due to shipping.

Attachment 1

SWIMMING POOL HEATING SYSTEM EVALUATION

1. The charts displayed for an outdoor pool

Energy flows in a heated pool

Energy flows in an unheated pool

Pool temperature

Range of pool temperature(max exceeded for 5% of the time and mini temperature exceed for 95% of the time.)

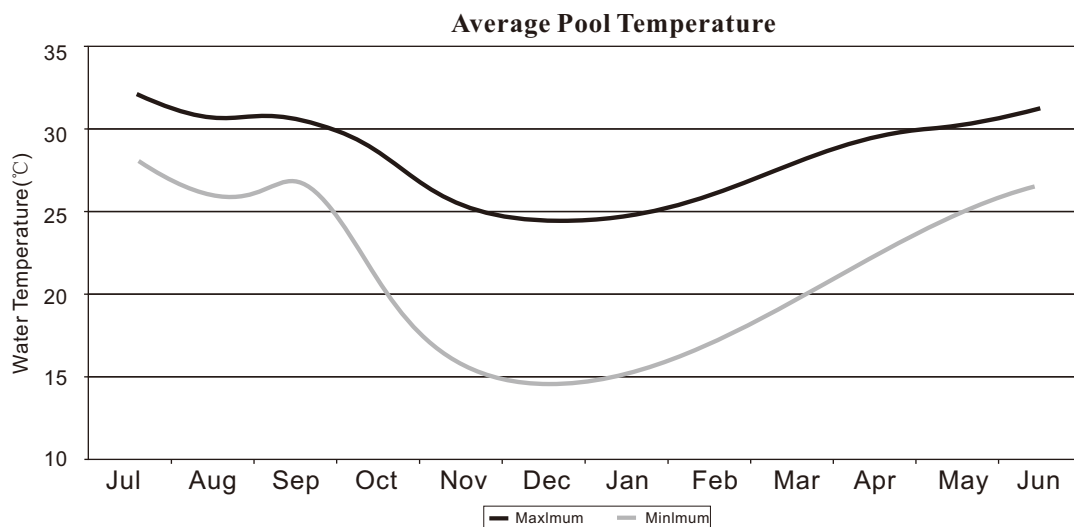

SWIMMING POOL HEAT PUMP

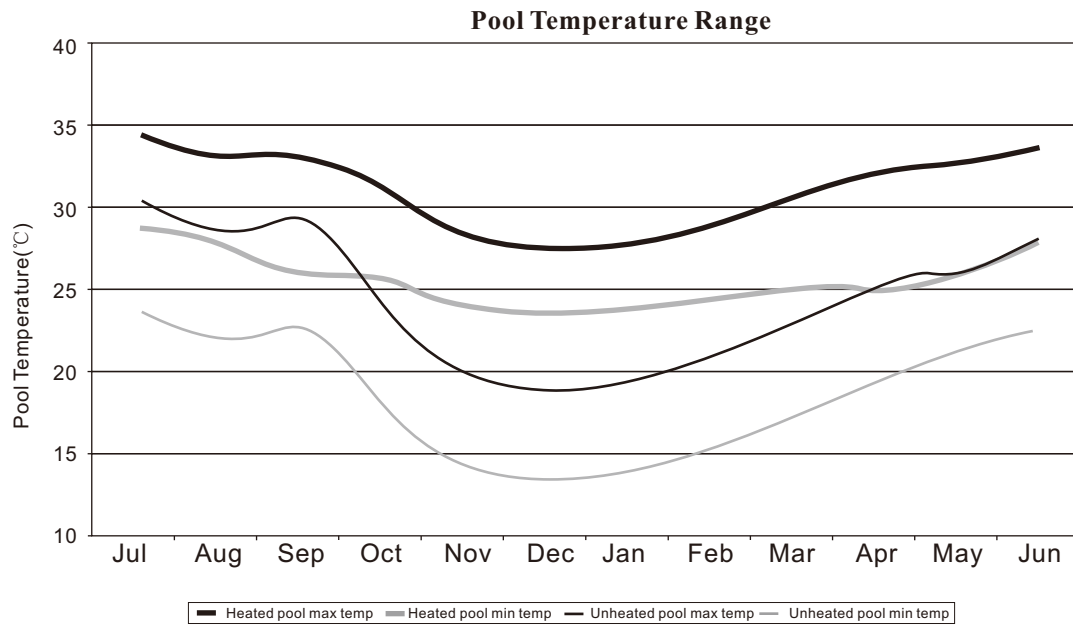

2. The charts displayed for an indoor pool are

- Energy flows for indoor pool.
- Pool temperature during daytime operating period.
- Space temperature during daytime operating period.
- Space humidity during daytime operating period.
- Pool temperature at night.
- Space temperature at night.
- Space humidity at night.

Some of the charts are.

**Pool Temperature
operating period**

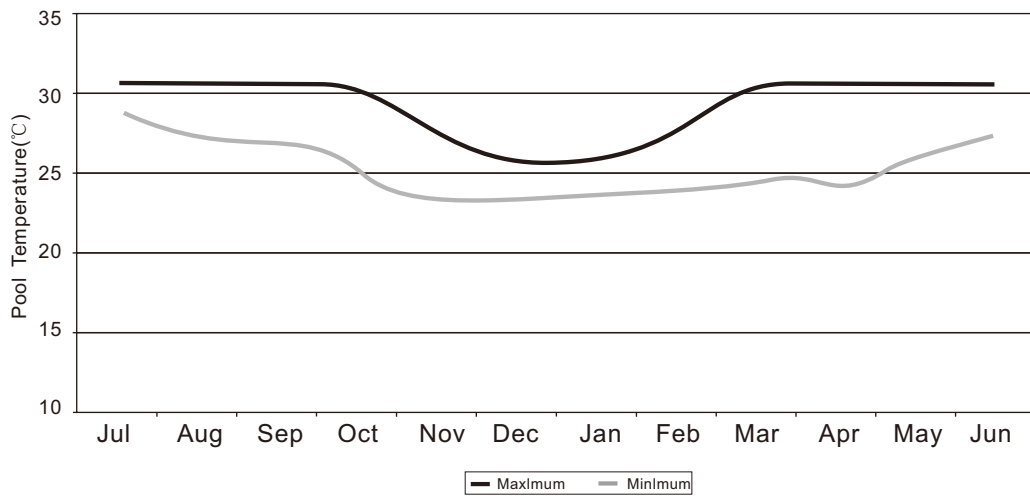

SWIMMING POOL HEAT PUMP

Space Temperature operating period

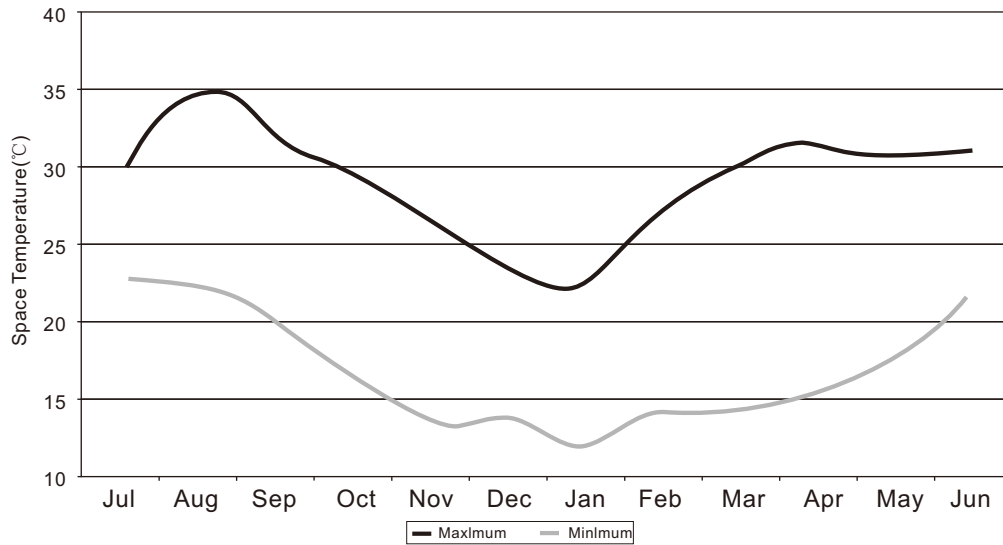

Space Humidity operating period

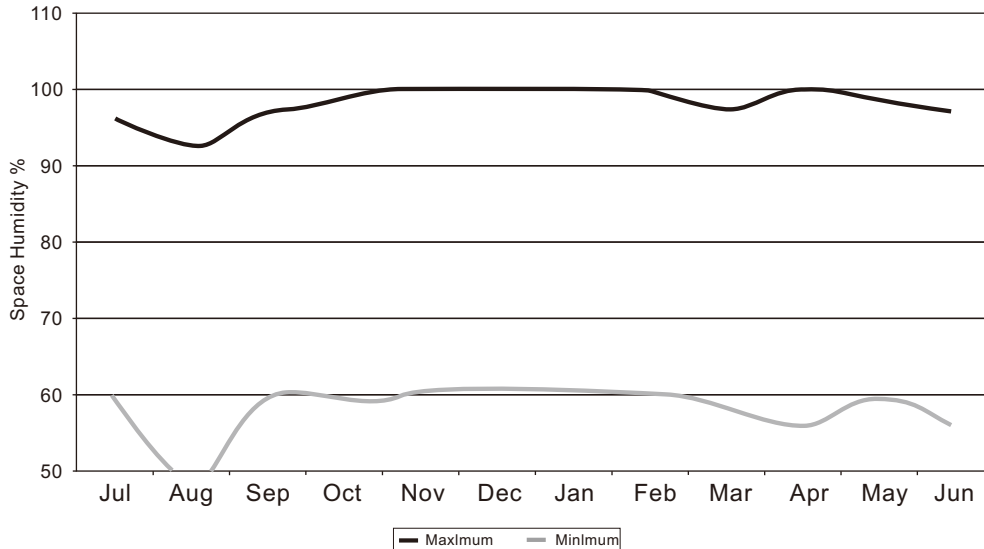

The position of installing unit

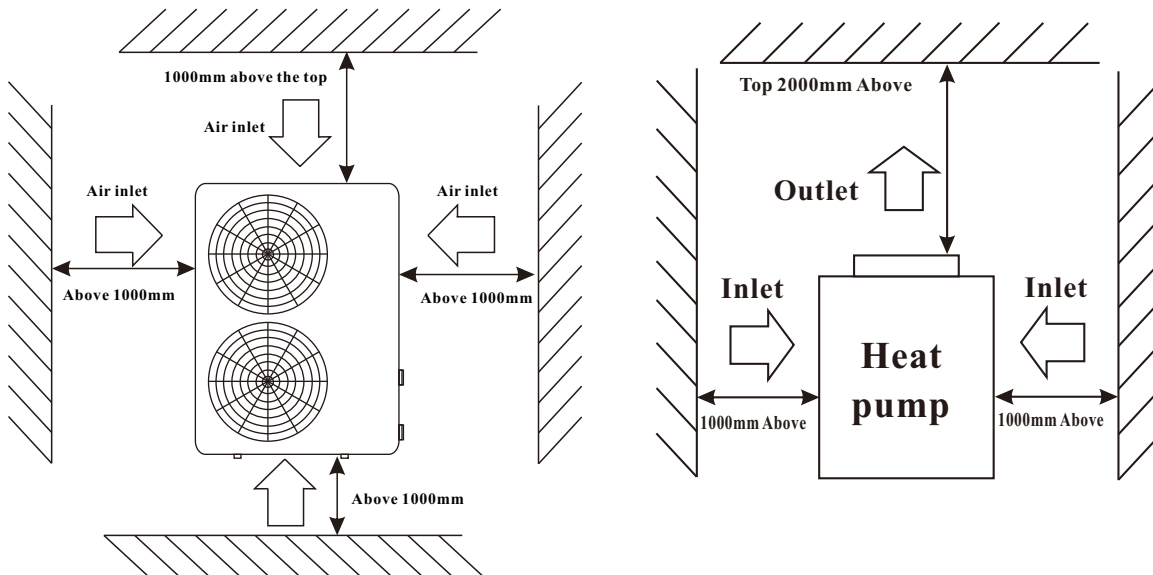

SWIMMING POOL HEAT PUMP

Attachment 2

The Installation about Heat Pump & Chlorinator

Pressure-type Chlorinator or Brominator

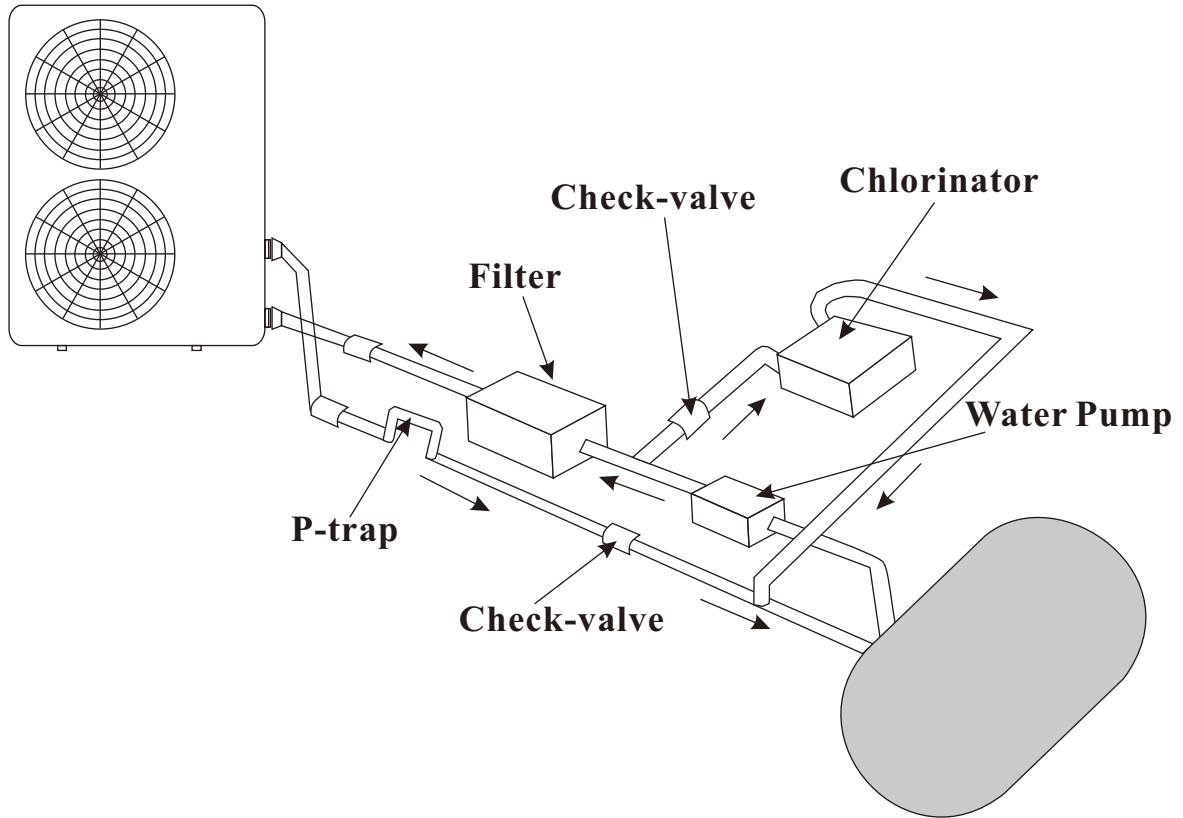

In-line Chlorinator or Brominator

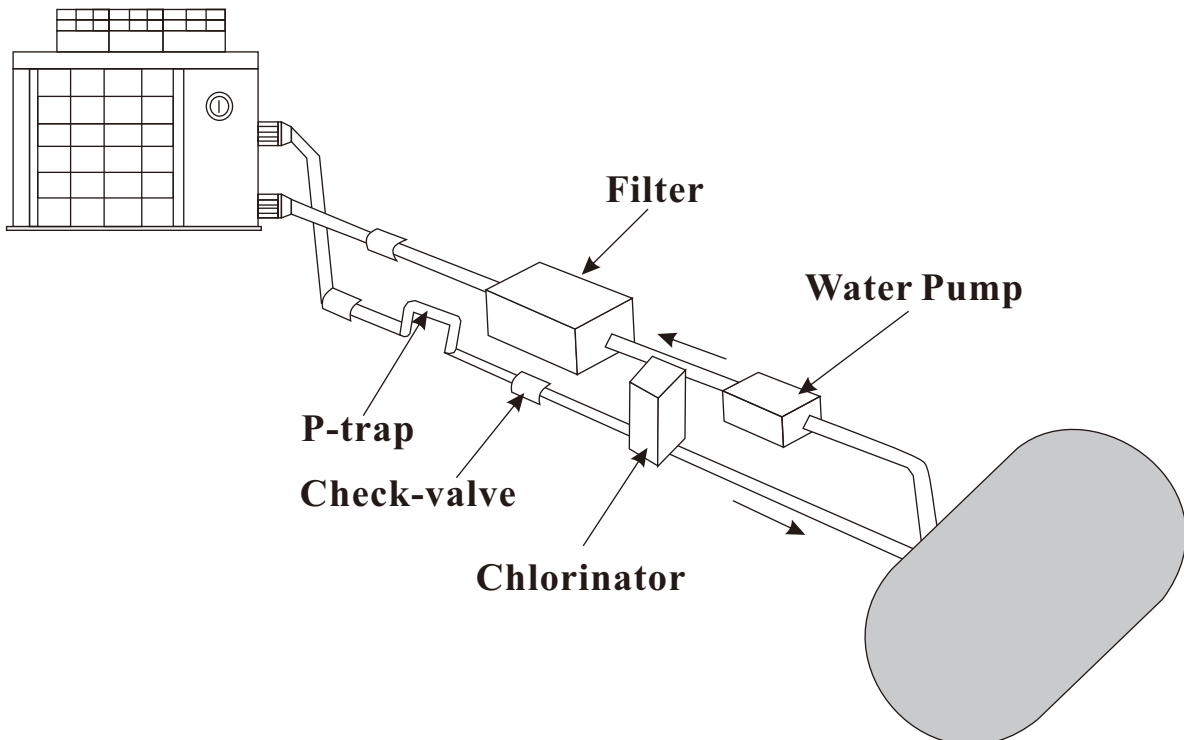

SWIMMING POOL HEAT PUMP

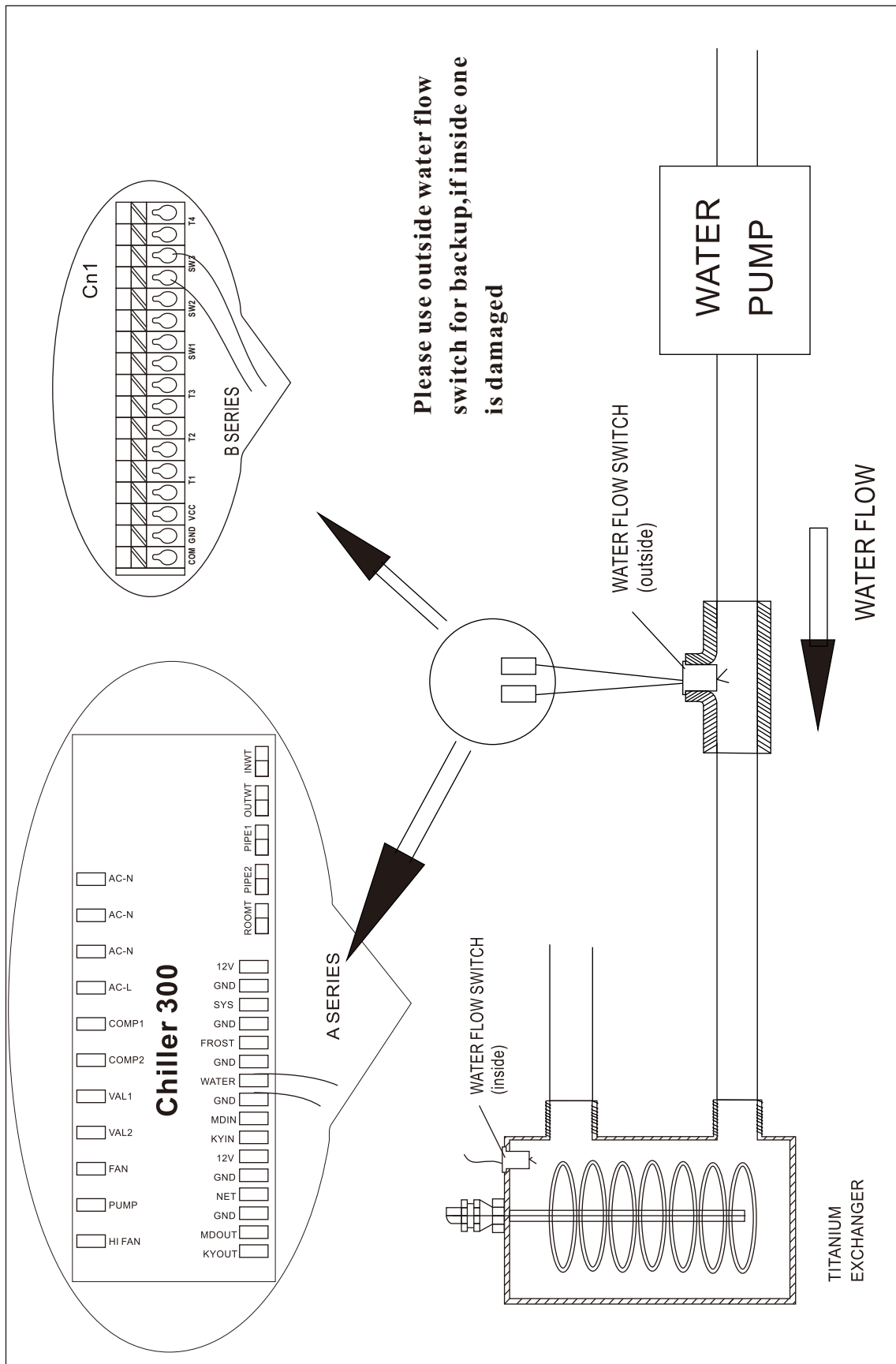

SWIMMING POOL HEAT PUMP

Attachment 3

Common Units Conversion

Linear Measure

1 inch=25.4 millimetres
1 foot=12 inches=0.3048 metre
1 yard=3 feet=0.9144 metre
1 (statute)mile=1760 yards=1.609 kilometres
1 nautical mile=1852 m.

Square Measure

1 square inch=6.45 sq.centimetres
1 square foot=144 sq.in.=9.29 sq.decimetres
1 square yard=9 sq.ft.=0.836 sq.metre
1 acre=4840 sq.yd.=0.405 hectare
1 square mile=640 acres=259 hectares

Cubic Measure

1 cubic inch=16.4 cu.centimetres
1 cubic foot=1728 cu.in.=0.0283 cu.metre
1 cubic yard=27 cu.ft.=0.765 cu.metre

Capacity Measure

British

1 pint 20 fluid oz.=34.68 cu.in.=0.568 litre
1 quart=2 pints=1.136 litres
1 gallon=4 quart=4.546 litres
1 peck=2 gallons=9.092 litres
1 bushel=4 pecks=36.4 litres
1 quarter=8 bushels=2.91 hectolitres

American dry

1 pint=33.60 cu.in.=0.550 litre
1 quart=2 pints=1.101 litres
1 peck=8 quarts=8.81 litres
1 bushel=4 pecks=35.3 litres

American liquid

1 pint=16 fluid oz.=28.88 cu.in.=0.473 litre
1 quart=2 pints=0.946 litre
1 gallon=4 quarts=3.785 litres

Avoirdupois Weight

1 grain=0.065 gram
1 dram=1.772 grams
1 ounce=16 drams=28.35 grams
1 pound=16 ounces=7000 grains=0.4536 kilogram
1 stone=14 pounds=6.35 kilograms
1 quarter= 2 stones=12.70 kilograms
1 hundredweight=4 quarters=50.80 kilograms
1 short ton=2000 pounds=0.907 tonne
1 (long)ton=20 hundredweight=1.016 tonnes

energy, power

1 usrt=3024 kcal/h=3516 w
1 kcal/h=1.163 w
1 kw=860 kcal/h
1 btu/h=0.293 w

velocity, flux

1 m/s=196.85 fpm
1 cfm=1.699 cmh
1 gpm=0.27276 cmh
1 gpm=0.2271 cmh

Pressure

1 bar=100000 pa
1 psi=0.0703 kgf/cm²
1 kgf/cm²=98000 pa
1 mm aq.=9.8 pa
1 mm hg=133.28 pa
1 m H₂O=9800 pa=0.1 kgf/cm²

