

SWIMMING POOL

HEAT PUMP UNIT

Installation & Instruction Manual

— English Version —

Model: SBR-50.0H-A-S

Contents

Performance Data Specifications

1.Performance data of Swimming Pool Heat Pump Unit -----	1
2.The dimension for Swimming Pool Heat Pump --- -----	2
3.Wire controller operation guide-----	3
4.Maintenance-----	15
5.Wiring diagram -----	16

Service

1.How to Obtain Service-----	17
2.For Installing Dealer-----	17
3.Will Ever Need Freon-----	17

Attachment

1.The charts displayed for outdoor pool & indoor pool -----	17
2.The Installation about Heat Pump & Chlorinator-----	19
3.Common Units Conversion-----	20

Mac No. of this unit:	
------------------------------	--

Dear customers:

In order to use this machine safely, please read this user's manual carefully before using and installation, especially pay attention to each notice remark for usage and maintenance. Also keep it carefully for later use. Heat pump water heater is a professional machine, it may cause damage or hazard when wrong installed. Relevant installation and maintenance shall be done by technical people. Please contact our installation service for reference.



Important warning:

- This appliance can be used by children aged from 8 years and above and persons with reduced physical, sensory or mental capabilities or lack of experience and knowledge if they have been given supervision or instruction concerning use of the appliance in a safe way and understand the hazards involved.
Children shall not play with the appliance. Cleaning and user maintenance shall not be made by children without supervision.
- Children should be supervised to ensure that they do not play with the appliance.
- The specifications of fuse is: AC250V, 3.15A.
- The appliance must be fitted with means for disconnection from the supply mains having a contact separation in all poles that provide full disconnection under overvoltage category III conditions and these means must be incorporated in the fixed wiring in accordance with the wiring rules.
Please make sure that the unit and power connection have good earthing, otherwise may cause electrical shock..
- The running range of the heat pump:
 - (1) Heating : outlet water range:20 ~40°C, the ambient temperature range 0 ~ 32°C;
 - (2) Cooling : outlet water range:8 ~28°C, the ambient temperature range 20 ~ 43°C;
 - (3) the pressure of water : 14 ~ 18kpa
- Do not forget to connect the ground wire
- Use an exclusive power source with a circuit breaker

SWIMMING POOL HEAT PUMP

1. Performance data of Swimming Pool for A type

Model		SBR-50.0H-A-S	
Rated Heating Capacity	W	50000	
	BTU/h	170000	
Rated Cooling Capacity	W	36000	
	BTU/h	125000	
Heating Range	°C	20~40	
Cooling Range	°C	8~28	
Heating Input Power	W	11100	
Cooling Input Power	W	11250	
Running Current Heating	A	17.6×3	
Running Current Cooling	A	17.8×3	
COP	W/W	4.7	
EER	W/W	3.2	
Power Supply	V/PH/Hz	380V/3/50	
Compressor Type		Scroll	
Compressor Nos.		2	
Fan Motor Nos.		2	
Fan Motor Input	W	160×2	
Fan Speed	RPM	900	
Noise	dB(A)	63	
Water Connections	inch	2"	
Water Flow Volume	m ³ /h	8-15	
Water Pressure Drop	Kpa	18	
Unit Dimension	L	mm	1450
	W		710
	H		1060
Packing Dimension	L	mm	1600
	W		800
	H		1230
Weight	Net Weight	kg	235
	Gross Weight		265

Measurement conditions:
 outdoor air temp:24°C/19°C, inlet water temp:27°C

SWIMMING POOL HEAT PUMP

2. The dimension for Swimming Pool Heat Pump

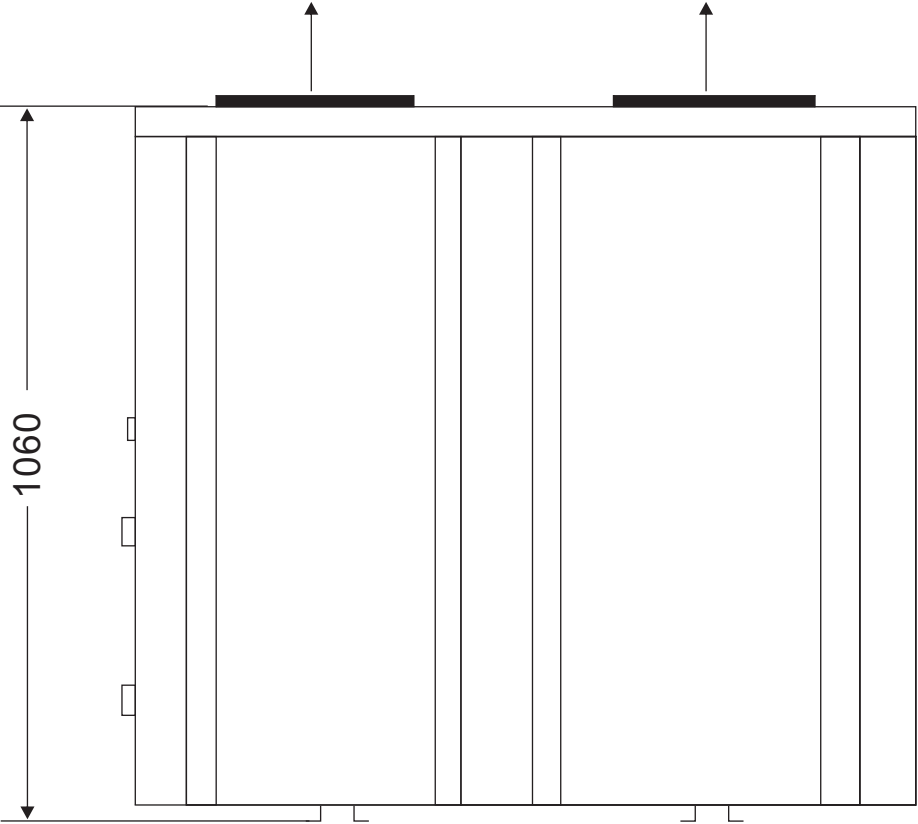
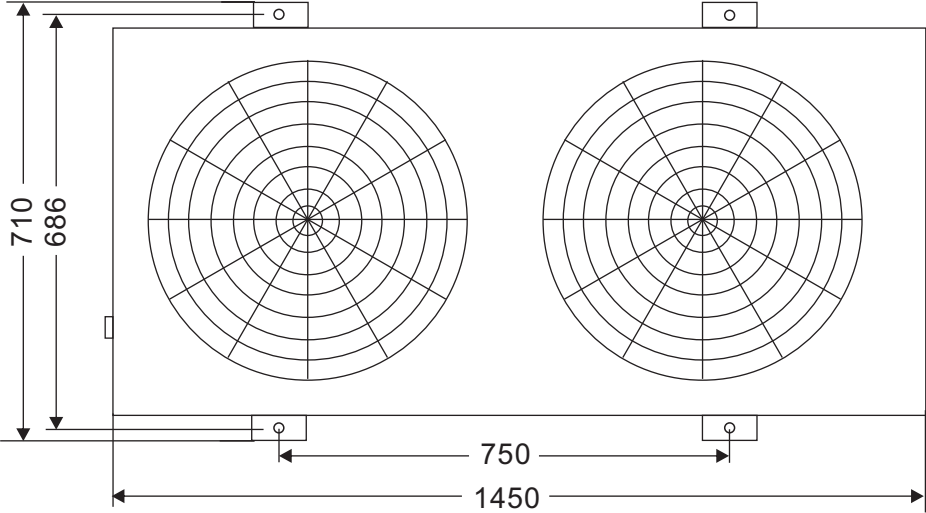

Measure: mm







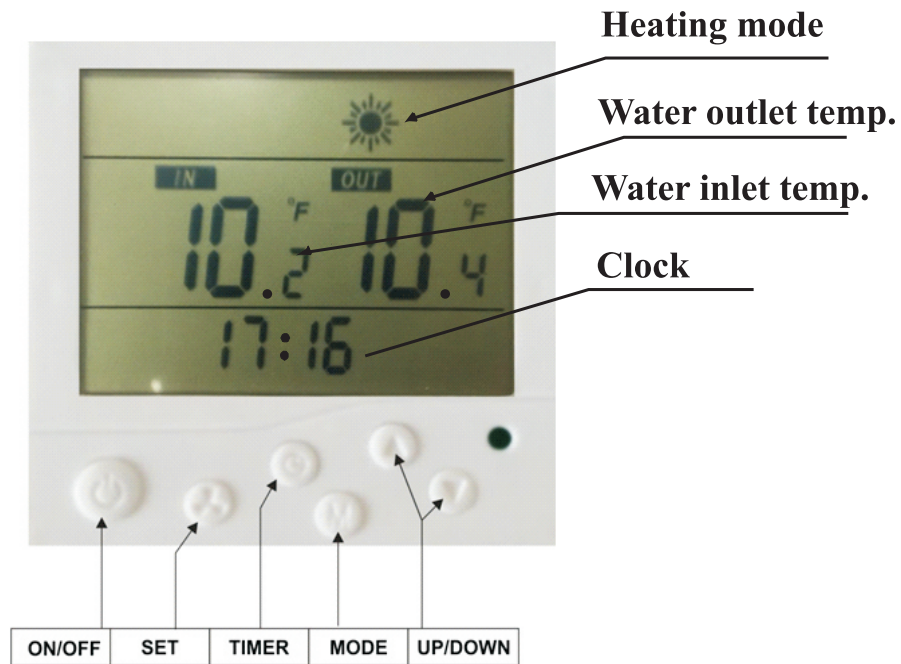







SWIMMING POOL HEAT PUMP

3. Wire controller operation guide

1). Controller introduction



2) Wire controller button definition

-  button
---to turn on or turn off your heat pump.
-  and  button
-----up and down button to check or change setting.
Press these two button at the same time for 3seconds, lock the keyboard.
-  button
Press  button alone, could come to clock setting. First set the hour data, and use  or  button to change the hour data.
Secondly press  again, to come to minute data setting. Still use  or  button to change the minuted data. After that, press  to confirm.
-  button
---Press  for 3 seconds in standby status, could enter for Force Defrost.
-  button
-----Button for timming.Integrating with up and down button, to set the time for turning on or turning off the heat pump.

SWIMMING POOL HEAT PUMP

3) Wire Controller Operation

- ◎ In the state of OFF, LCD display clock and working mode only.

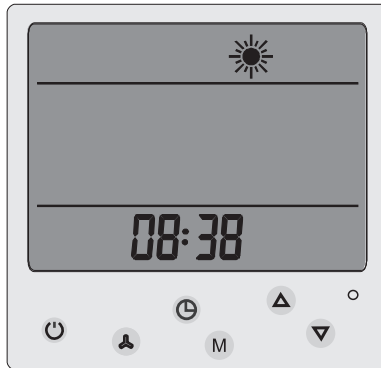

- ◎ When Press “power” button, heat pump turn on, and LCD display as below.



Parameter data setting

You could check and change the setting from any status as below steps.

1. Press up/ down button for the parameter you want to change setting.
2. When the **SET** appearing on the screen ,means you can change the data.
2. Press button once, and the right data flash
3. Use up/down button to change the setting.
4. Press button again for confirm.

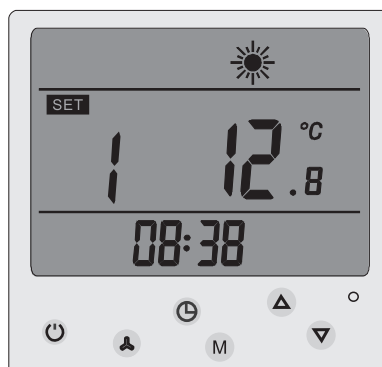

SWIMMING POOL HEAT PUMP

◎ Real Time Clock Setting

In the default state, press "☀" once to enter Real Time Clock Setting State; In the state of Real Time Clock Setting, press "☀" once again, hour numbers flash, press "▲" or "▼", can adjust the hour for the clock. After the clock hour is setted, press "☀" once again, minute numbers flash, press "▲" or "▼", can adjust the minute for the clock. After setting the clock minute, press "☀" again to confirm the clock setting and return default state.

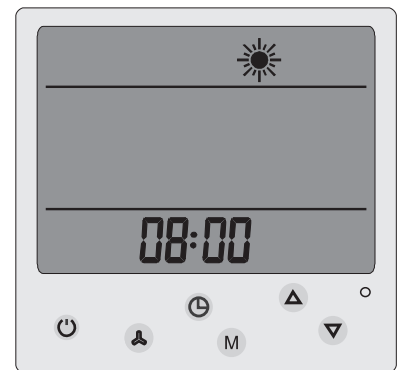

◎ Timming ON /OFF Setting

In default state, press "⌚" once to enter Timing Setting state. press "⌚" again, the hour numbers for timming ON flash, press "▲" or "▼" to adjust the hour for timming ON setting.

After setting the hour for timming ON, press "⌚" once again, the minute number for timming ON flash, press "▲" or "▼" to adjust the minute for timming ON.

After setting the minute for timming ON, press "⌚" once again, to enter the hour setting of timming OFF;

After setting the timming OFF hour and minute, press "⌚" again, to confirm current setting and return to default state.

In the state of Timming Setting, press "⌚" once again, when the timming ON/OFF setting is set at the same time, the timming ON/OFF setting is cancelled.

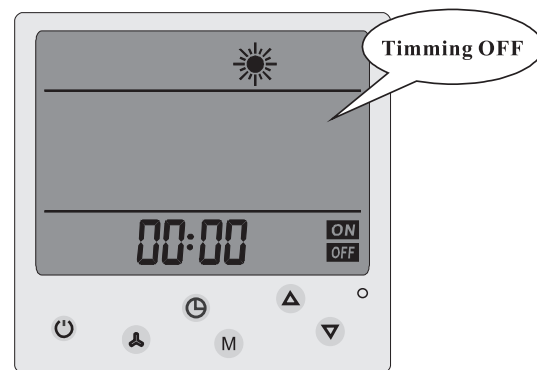
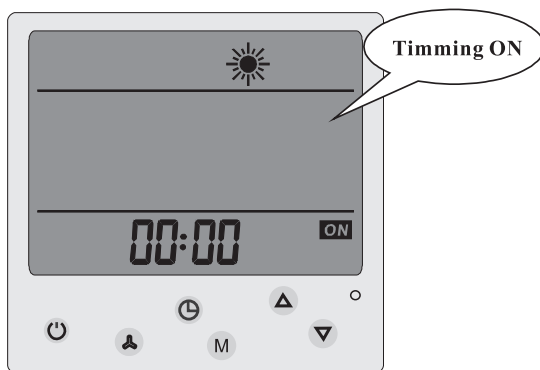

◎ Back Up Memory After Power Resumption

When the heat pump is working in normal state and electricity power cut off suddently, the system will run in the last setting record after power resumption.

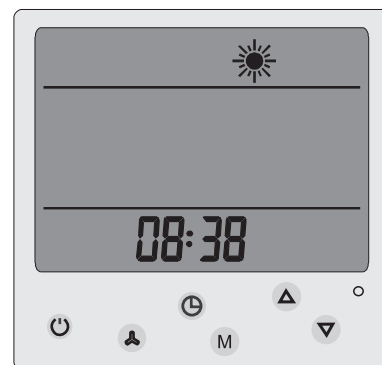

SWIMMING POOL HEAT PUMP

3) Parameters

Digit	Meaning	Range	Default	Remarks
SET0	Cold water set point temp	8-28°C	12°C	Can adjust
SET1	Hot water set point temp	20-40°C	40°C	Can adjust
SET2	Auto backwater set point temp	8-40°C	27°C	Can adjust
SET19	Tank water set point temp	25-60°C	55°C	Can adjust
1	Water inlet temp	0~99°C		Tested data
2	Water outlet temp	0~99°C		Tested data
3	Coil temp of system 1	-35~80°C		Tested data
4	Coil temp of system 2	-35~80°C		Tested data
5	Air circulation temp 1	-35~80°C		Reserve
6	Air circulation temp 2	-35~80°C		Reserve
7	Ambient temp	-35~80°C		Tested data
8	Exhaust temp of system 1	0~125°C		Tested data
9	Exhaust temp of system 2	0~125°C		Tested data
10	Actual steps for EEV	100~470		Reserve
11	Tank water temp	0~99°C		Reserve

SWIMMING POOL HEAT PUMP

4) Failure code and parameter tables

Protect/Failure	Long-distance controller	Remark
Water inlet temperature sensor failure	PP 1	
Water outlet temperature sensor failure	PP2	
Coil temperature sensor 1 failure	PP3	
Air circulation temperature sensor 1 failure	PP4	
Ambient temperature sensor failure	PP5	
Coil temperature sensor 2 failure	PP6	
Winter anti-freezing protection I	PP7	
Winter anti-freezing protection II	PP7	
Air circulation temperature sensor 2 failure	PP8	
Exhaust temperature sensor 1 failure	PP9	
Exhaust temperature sensor 2 failure	PP10	
Exhaust 1 high temperature protection	PP 11	
Exhaust 2 high temperature protection	PP 12	
Water-in and water-out temp difference protection	PP 13	
Anti freezing under cooling mode	PP 14	
System high pressure protection	EE 1	
System low pressure protection	EE 2	
Water flow switch failure	EE 3	
Power source wrong/open phase	EE 4	
Water-in and water-out temp difference too much shut down protection	EE 5	
Wire controller communication failure	EE 8	
Defrosting		

SWIMMING POOL HEAT PUMP

5) Two ways to connect wifi

a. First way

● For Android System

- Install the APP of “SmartLink3 Demo”
- Turn on the heat pump, and make sure the area of heat pump installed cover with wifi signal. What's more, make sure your smart phone with wifi connected.
- Long press the ON/OFF button and DOWN button of LCD controller for 10 seconds. See below pic.

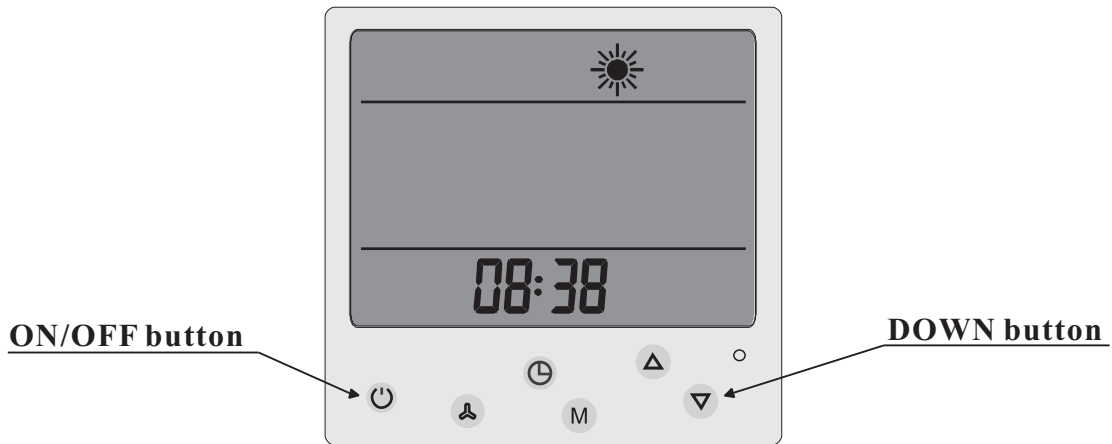

- Then input the password for example 12345678 of WIFI TP LINK-22233. **(The wifi should be your local wifi, and your password of local wifi)** And press “Start”, see below pic. (Your smart phone should near the controller to ensure easy connected for wifi)

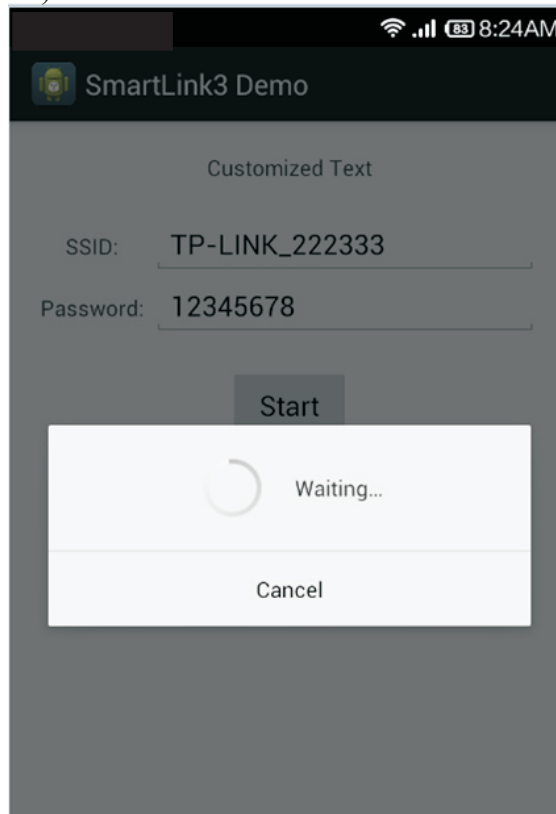

SWIMMING POOL HEAT PUMP

a. First way

- It may take 1 minute to match all wifi setting.

If connected successful, it could show “**SmartLink Compeltd**” as below pic.

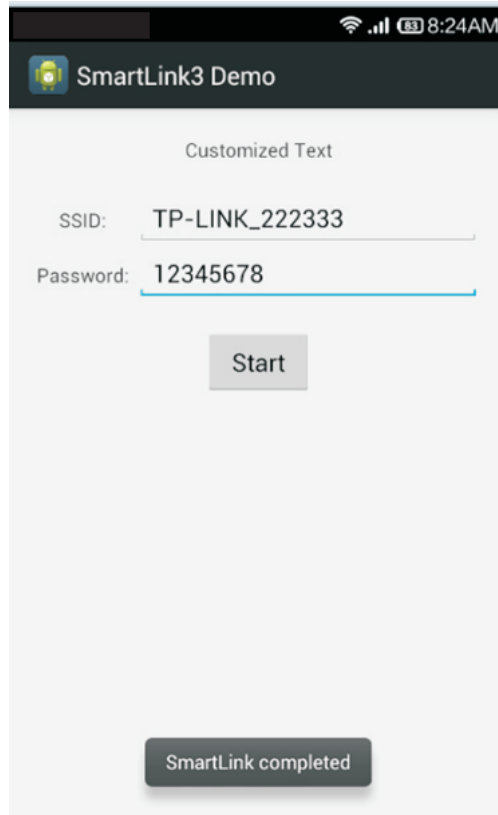

- If failed, it could show “**time out**”as below pic, then you have to repeat step 3 & 4 again.

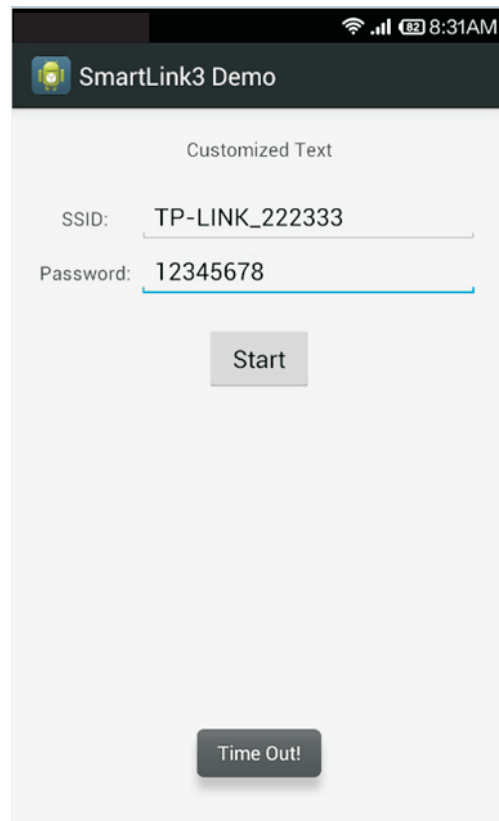

SWIMMING POOL HEAT PUMP

a. First way

- **For IOS System**

- Find out “SmartLink” in the APP Store, download and install it.

You can scan below QR code for fast installation as well.

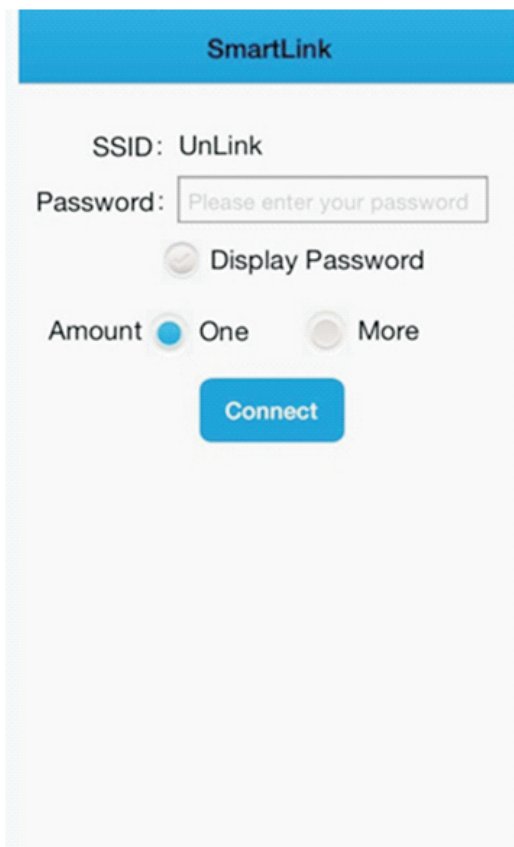

- Input the passwords of your local wifi.

A screenshot of the SmartLink app's WiFi connection screen. The title bar is blue with the text "SmartLink". Below it, the SSID is displayed as "UnLink". There is a "Password:" label followed by a text input field containing the placeholder text "Please enter your password". Below the input field is a "Display Password" toggle switch, which is currently turned off. At the bottom, there are two radio button options for "Amount": "One" (which is selected) and "More". A blue "Connect" button is positioned at the bottom center of the screen.

- Other setting please refer to Android system, as they are the same.
Remarks, initial wifi setting may need a few times to complete. Please try more times if once is not successful.

SWIMMING POOL HEAT PUMP

b. Second way for wifi setting

- Turn on the heat pump.
- Use laptop or smart phone to find wifi “HF-LPB100”and connect it.
- Open website of “10.10.100.254” , input user name and password as below.

User name: admin Password: admin

After that, you could find below interface.



- Select work mode, change to STA mode. And then press Save.
See below ref pic.

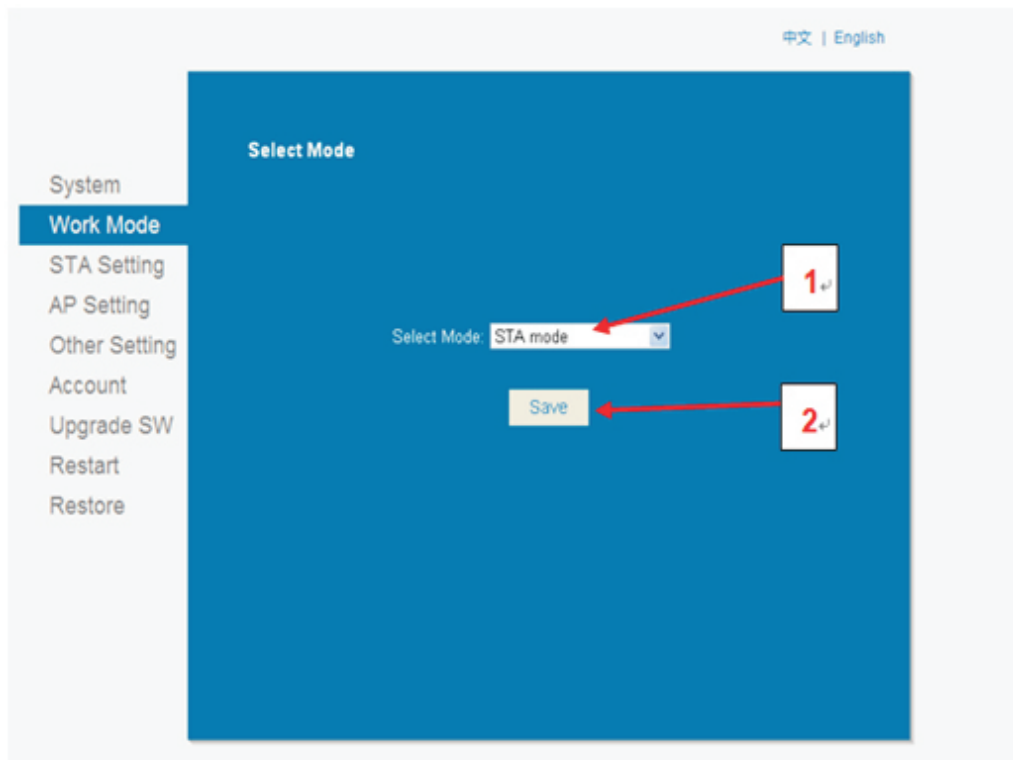

SWIMMING POOL HEAT PUMP

b. Second way for wifi setting

- Then select STA setting, press Scan, then press Save. See below refer pic.

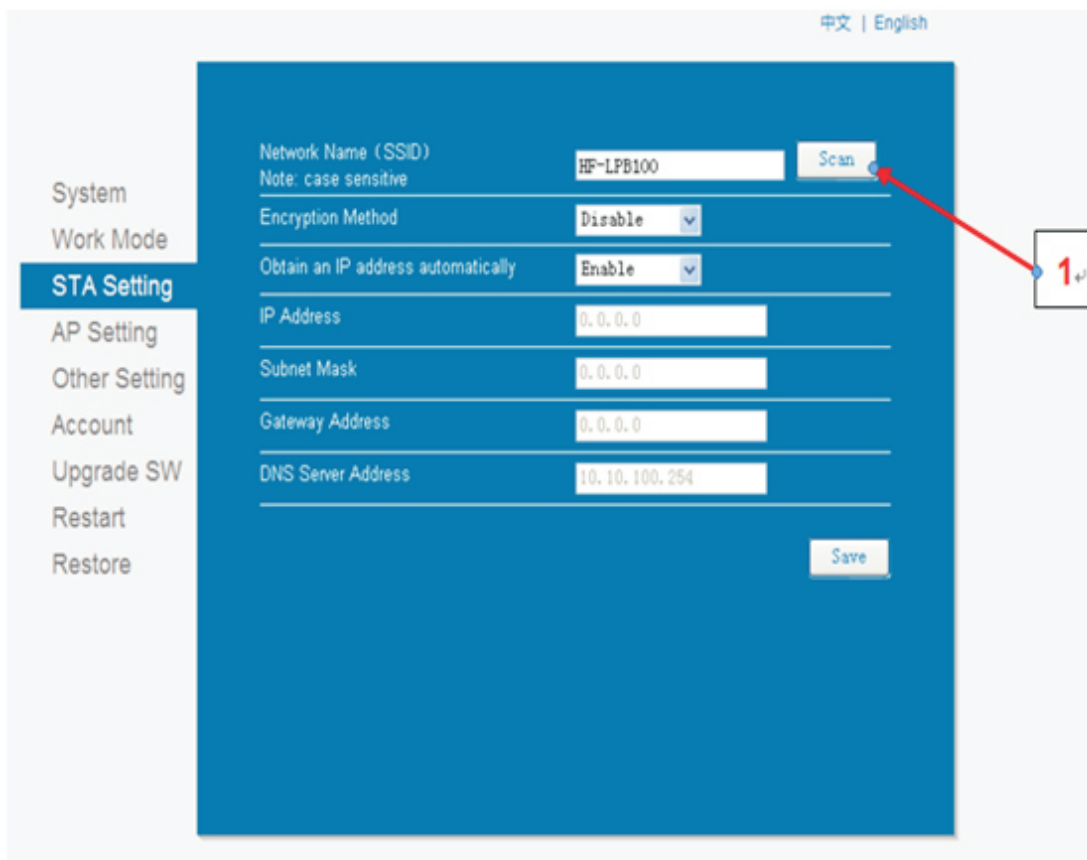

- Please choose the safety and reliable local area network which available. Then press OK to Confirm.

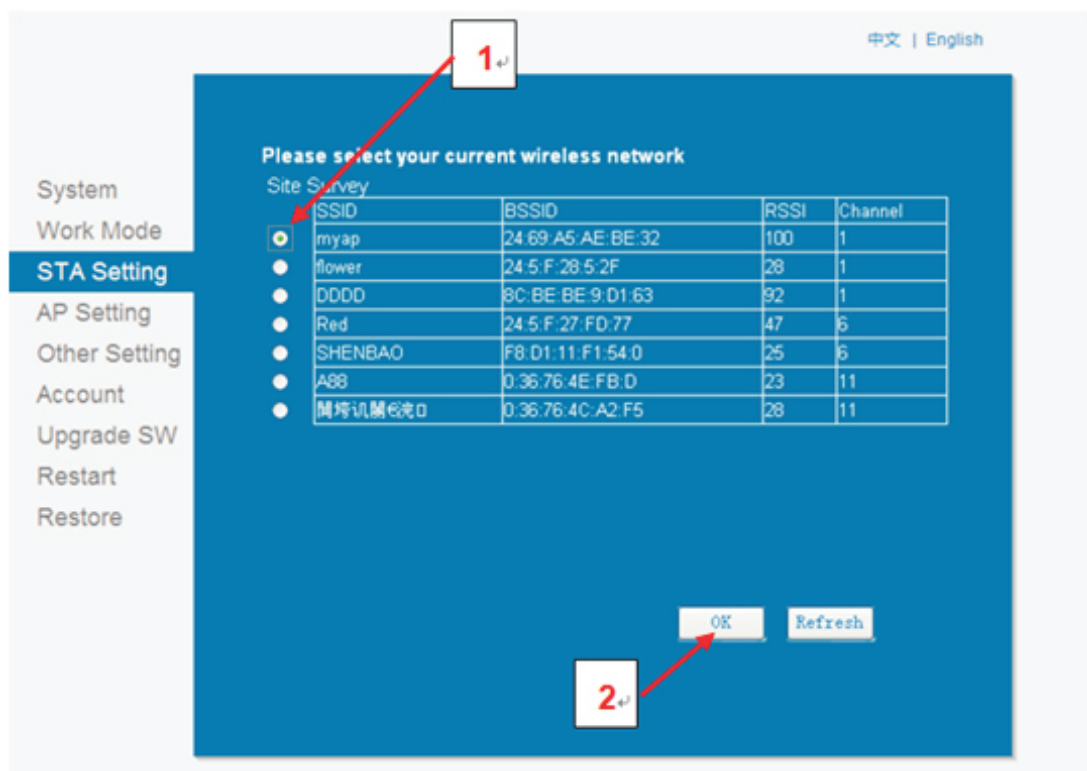

SWIMMING POOL HEAT PUMP

b. Second way for wifi setting

- Make sure the Encryption Method choose **WPA2PSK**, and Encryption Algorithm choose **AES**. Input the **password** of your local area network. Then press **Save**.



- After finished all above steps, come to Restart interface, and press OK to confirm RESTART. See below pic.

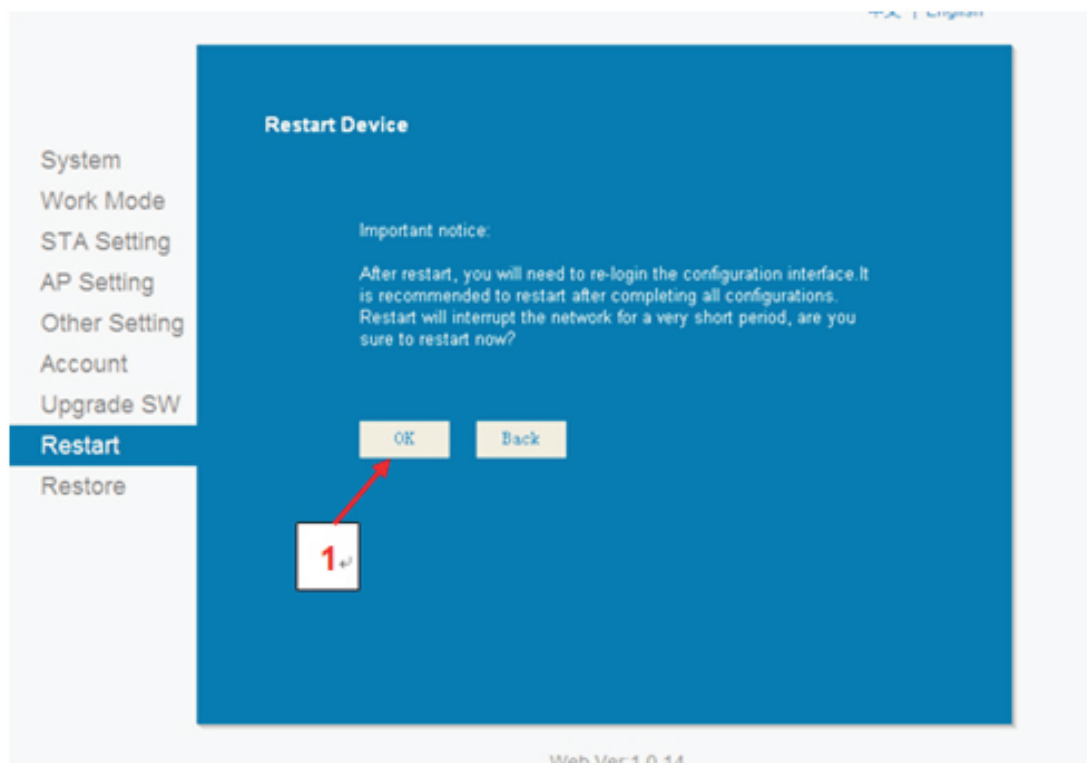

SWIMMING POOL HEAT PUMP

c. Remarks

- Make sure to press “SAVE” for each setting.
- If IP address changed, all above setting need to re-set.
- If you try first way of “Smartlink3 DEMO” and failed, then try the second way for wifi setting.
- Long press turn ON/OFF button and UP button for 10 seconds ,wifi will restore the default state.(see below pic)

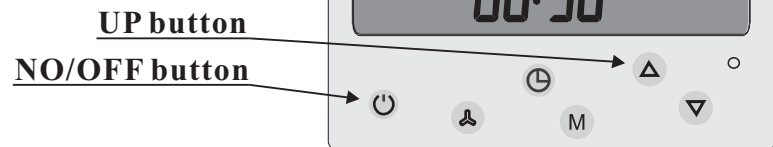

d. Fast Inquiry

- After wifi connected successful, you could have inquire about heat pump status by below website. <http://app.xlink.cn:9001/query.html>
Or you could scan below QR Code to enter the website for Heat pump status checking.
Fast inquire (only to check 1 or 2 heat pump units)



- Agent research (Able to check all the heat pumps as order). Or visit below website.
<http://app.xlink.cn:9001/login.html>



SWIMMING POOL HEAT PUMP

4. Maintenance

- **To check the water supply device often. You should avoid the condition of no water or air entering into system, or that will influence unit's performance and reliability. You should clear the water filter regularly to avoid unit's damage by filter' jam.**
- **There should be dry, sanitary and ventilation around the unit. To clean the side condenser regularly for good heating exchanging and saving energy.**
- **To check the power supply and cable connection often, to see if there is abnormal action or bad smell about the electrical component. If yes, Contact Installer immediately.**
- **Please discharge all water in the water pump and water system lest freeze the water pump or water system. You should discharge the water at the bottom of water pump if the units will stop for long time. And you should check the units thoroughly and fill the system with water fully before power on the units again.**

SWIMMING POOL HEAT PUMP

5. Wiring diagram

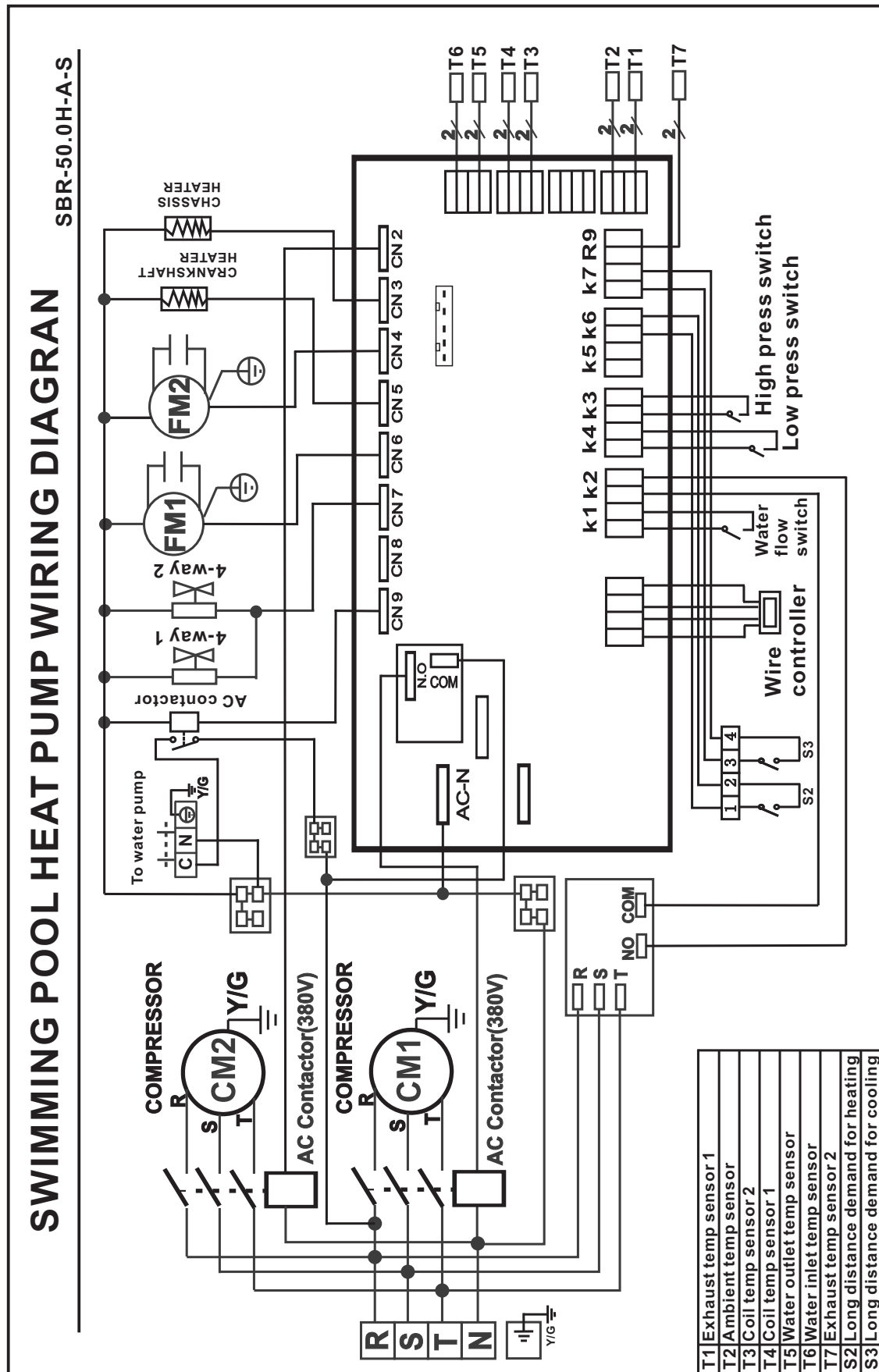

SWIMMING POOL HEAT PUMP

Service

1. How to obtain Service For Pool Owner

If you are having trouble with the unit, please contact the Installer immediately.

1. Provide your Dealer with the following information:

- A. Serial # located on back panel nameplate .
- B. Proof of Installation Date (Bill of sale or original invoice only)
- C. Description of the Symptoms

2. For Installing Dealer

If your customer is having a problem and you as the installing dealer have verified that the cause is NOT external to my company (such as tripped breaker, clogged pool filter, inadequate pump run time, etc.) following these steps will help you obtain the fastest service possible for your customer.

1. Help your customer gather the following information:

- A. Serial # located on back panel nameplate .
- B. Proof of Installation Date (Bill of sale or original invoice only)

3. Will Ever Need Freon

Unless there is a leak in the sealed refrigeration system, the factory charge of freon should last for the life of the unit. Freon is very stable and should not degrade or breakdown even under severe operating conditions. If your unit needs freon, then it has a leak, and adding freon will not solve the problem. The leak must be located and repaired. Fortunately, freon leaks are very uncommon and usually are due to shipping.

Attachment 1

SWIMMING POOL HEATING SYSTEM EVALUATION

1. The charts displayed for an outdoor pool

Energy flows in a heated pool

Energy flows in an unheated pool

Pool temperature

Range of pool temperature (max exceeded for 5% of the time and mini temperature exceed for 95% of the time.)

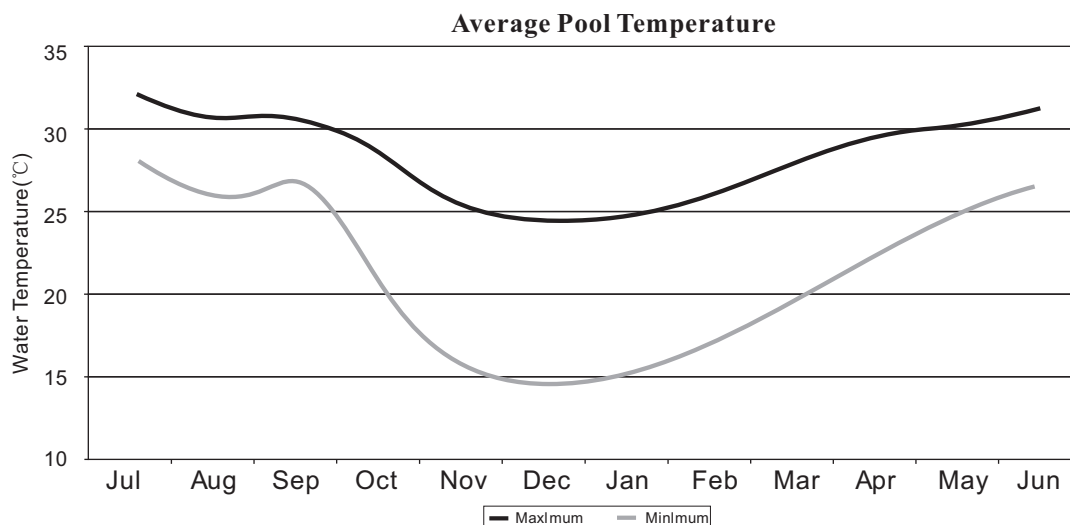

SWIMMING POOL HEAT PUMP

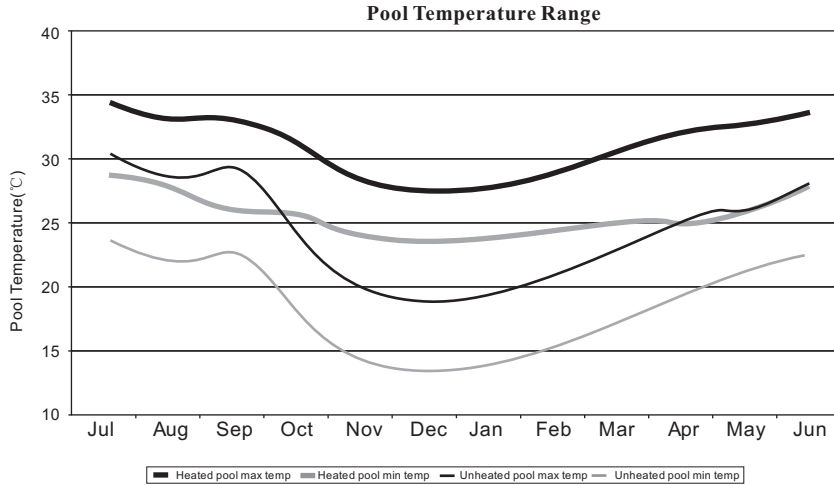

2. The charts displayed for an indoor pool

Energy flows for indoor pool.

Pool temperature during daytime operating period.

Space temperature during daytime operating period.

Space humidity during daytime operating period.

Pool temperature at night.

Space temperature at night.

Space humidity at night.

Some of the charts are.

Pool Temperature operating period

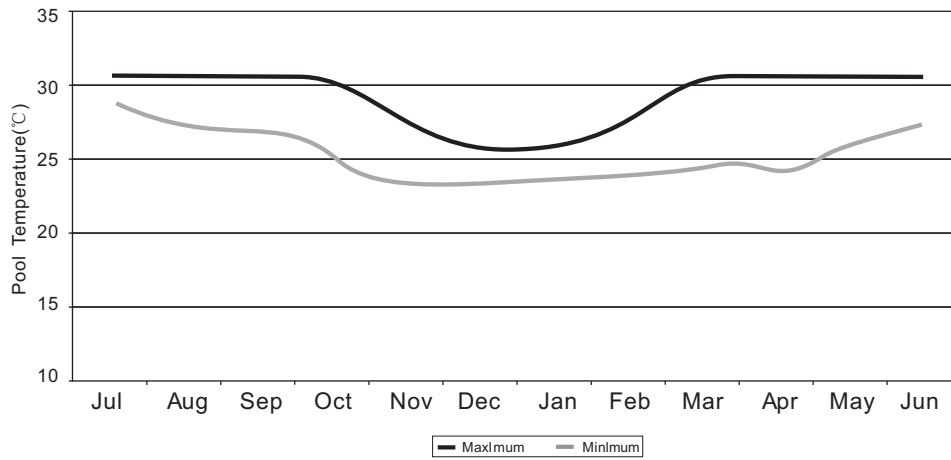

Space Temperature operating period

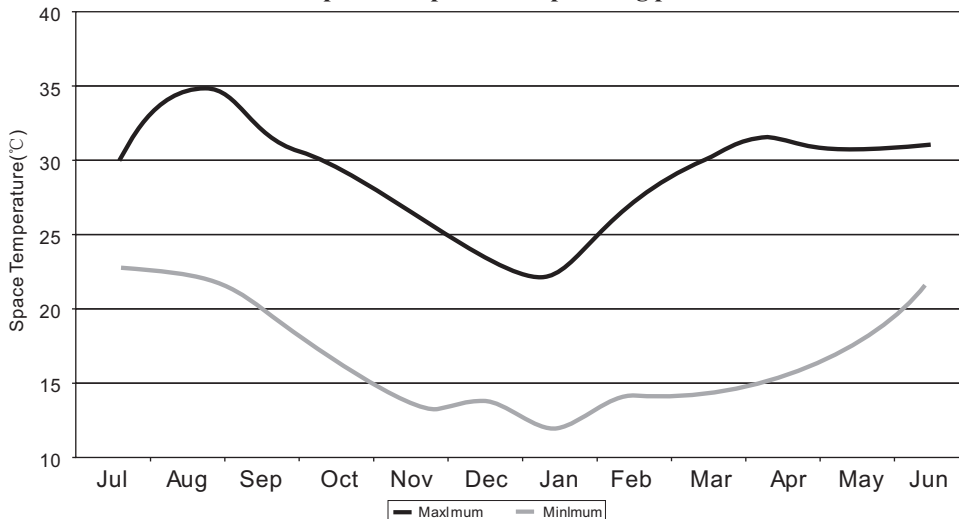

SWIMMING POOL HEAT PUMP

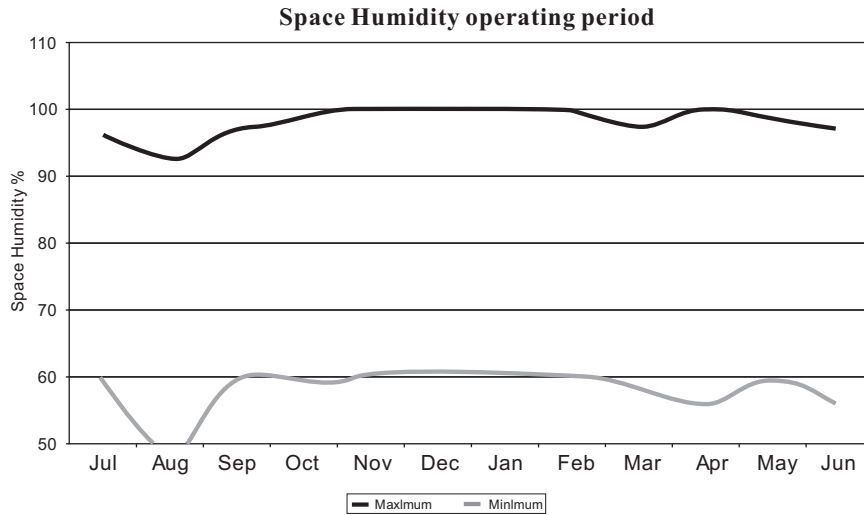

The position of installing unit

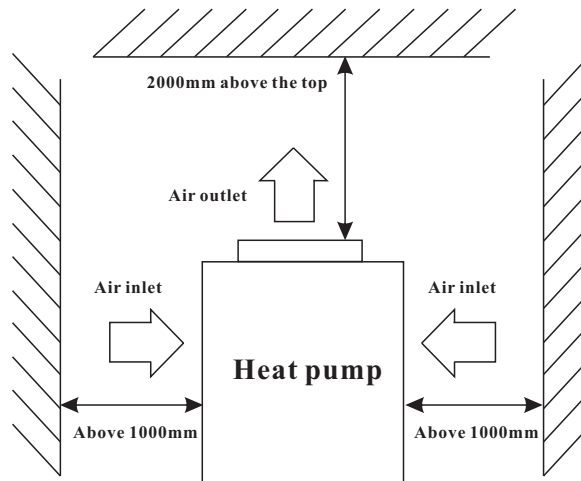

Attachment 2

The Installation about Heat Pump & Chlorinator

Pressure-type Chlorinator or Brominator

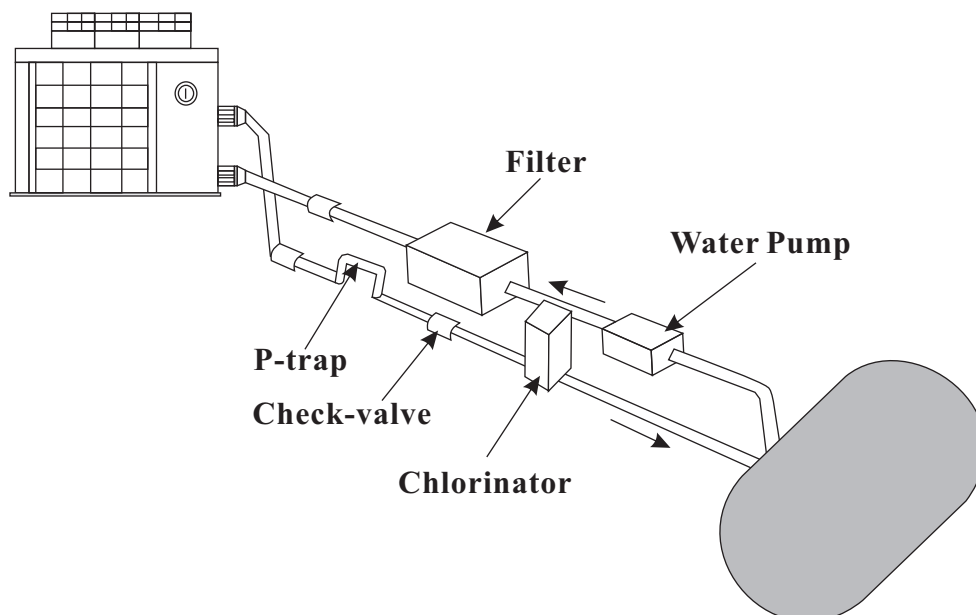

SWIMMING POOL HEAT PUMP

Attachment 3

Common Units Conversion

Linear Measure

1 inch=25.4 millimetres
1 foot=12 inches=0.3048 metre
1 yard=3 feet=0.9144 metre
1 (statute)mile=1760 yards=1.609 kilometres
1 nautical mile=1852 m.

Square Measure

1 square inch=6.45 sq.centimetres
1 square foot=144 sq.in.=9.29 sq.decimetres
1 square yard=9 sq.ft.=0.836 sq.metre
1 acre=4840 sq.yd.=0.405 hectare
1 square mile=640 acres=259 hectares

Cubic Measure

1 cubic inch=16.4 cu.centimetres
1 cubic foot=1728 cu.in.=0.0283 cu.metre
1 cubic yard=27 cu.ft.=0.765 cu.metre

Capacity Measure

British

1 pint 20 fluid oz.=34.68 cu.in.=0.568 litre
1 quart=2 pints=1.136 litres
1 gallon=4 quart=4.546 litres
1 peck=2 gallons=9.092 litres
1 bushel=4 pecks=36.4 litres
1 quarter=8 bushels=2.91 hectolitres

American dry

1 pint=33.60 cu.in.=0.550 litre
1 quart=2 pints=1.101 litres
1 peck=8 quarts=8.81 litres
1 bushel=4 pecks=35.3 litres

American liquid

1 pint=16 fluid oz.=28.88 cu.in.=0.473 litre
1 quart=2 pints=0.946 litre
1 gallon=4 quarts=3.785 litres

Avoirdupois Weight

1 grain=0.065 gram
1 dram=1.772 grams
1 ounce=16 drams=28.35 grams
1 pound=16 ounces=7000 grains=0.4536 kilogram
1 stone=14 pounds=6.35 kilograms
1 quarter= 2 stones=12.70 kilograms
1 hundredweight=4 quarters=50.80 kilograms
1 short ton=2000 pounds=0.907 tonne
1 (long)ton=20 hundredweight=1.016 tonnes

energy, power

1 usrt=3024 kcal/h=3516 w
1 kcal/h=1.163 w
1 kw=860 kcal/h
1 btu/h=0.293 w

velocity, flux

1 m/s=196.85 fpm
1 cfm=1.699 cmh
1 gpm=0.27276 cmh
1 gpm=0.2271 cmh

Pressure

1 bar=100000 pa
1 psi=0.0703 kgf/cm²
1 kgf/cm²=98000 pa
1 mm aq.=9.8 pa
1 mm hg=133.28 pa
1 m H₂O=9800 pa=0.1 kgf/cm²

