

●●● **BM fan coil unit-C series**

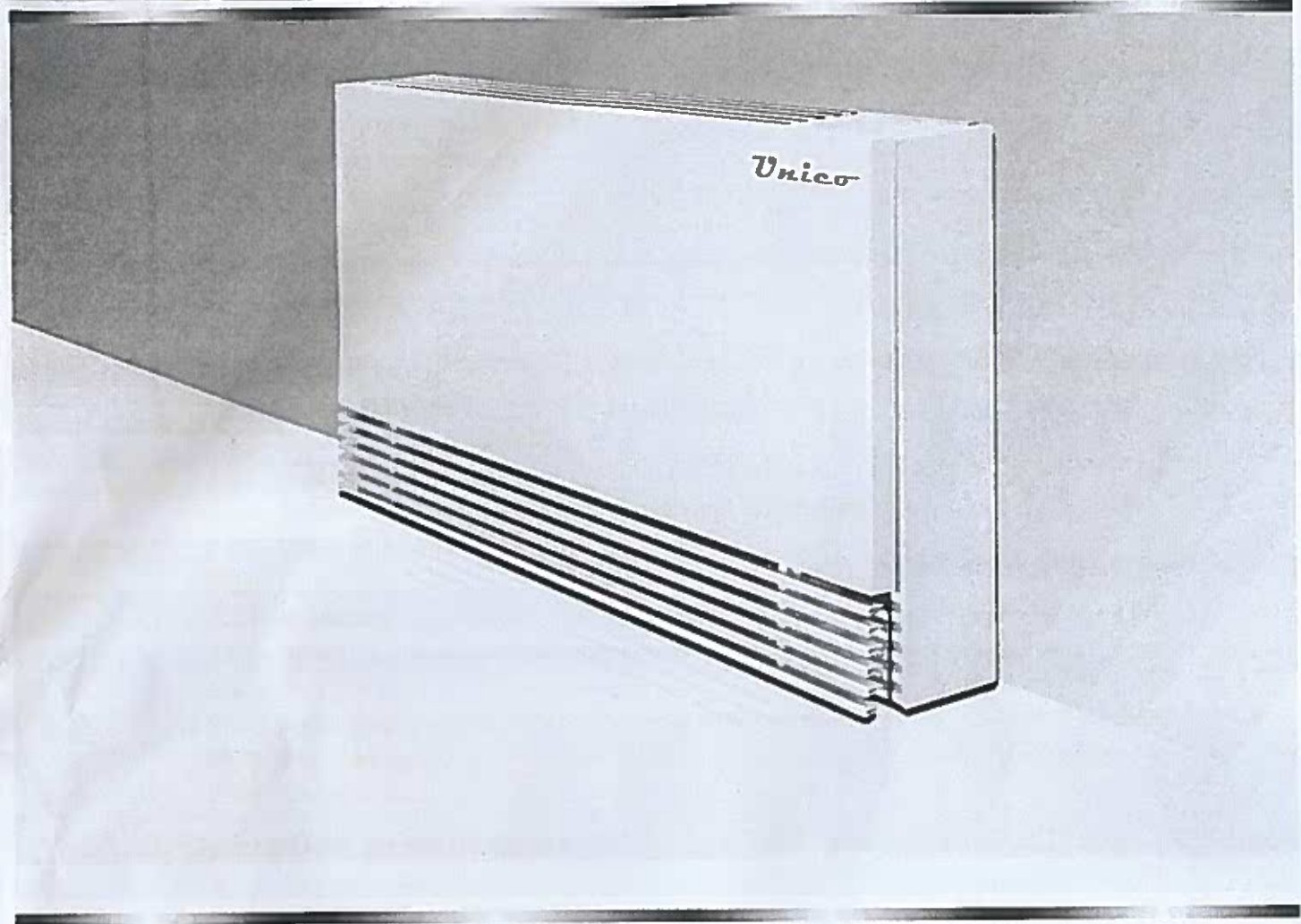

**INSTALLATION AND  
USER'S MANUAL**

☆ Before operating this unit, please read this  
manual and keep it well for future reference

# Catalogue

## 1. Introduction

1.1	General Information .....	1
1.2	Precautions .....	1
1.3	Features .....	4
1.4	Operation Temperature Range .....	4

## 2. Installation

2.1	Transportation and handling .....	5
2.2	Handling instructions .....	5
2.3	Dimensions .....	6
2.4	Parts description .....	8
2.5	Unit Installation .....	8
2.6	Precautions .....	9
2.7	Accessories .....	9
2.8	Installation .....	10
2.8.1	Before installation .....	10
2.8.2	Take off the air outlet grill .....	11
2.8.3	Wall mounted installation .....	11
2.8.4	Installation of feet (for the models with feet included only) .....	13
2.8.5	Water pipe connection .....	14
2.8.6	Filter .....	17
2.8.7	Insulation .....	18
2.8.8	Setting up the condensate drainage system .....	18
2.9	Test-run .....	18
2.9.1	Air purging .....	18
2.9.2	Pre Start-up .....	19
2.9.3	Unit Start-up .....	19

## 3. Operation Instructions

3.1	Operation panel .....	20
3.2	Operation instructions .....	21

## 4. Maintenance

4.1	Precautions .....	25
4.2	Cleaning the air filter .....	25
4.3	Check and clean the air inside water system occasionally .....	26
4.4	Drainage .....	26
4.5	Service to electric parts .....	26
4.6	Service to fan blade and fan motor .....	27
4.7	Circuit board changing .....	28

## 5. Appendix

5.1	Exploded view .....	30
5.2	Wiring diagram .....	32
5.3	Technical Data .....	33

# ▶ 1. Introduction

## 1.1 General Information

Thank you for choosing our product. Please read this manual carefully before use and follow the instructions to operate the unit in order to prevent damages on the device or injuries to staff. Specifications are subject to change with product improvements without prior notice. Please refer to the specification sticker on the unit for upgraded specifications.

## 1.2 Precautions

The precautions listed here are divided into following 3 types. They all cover very important topics, so be sure to follow them carefully.

! ..... Warning

⚠ ..... Caution

⊘ ..... Prohibition



Children should be supervised to ensure that they do not play with the appliance.

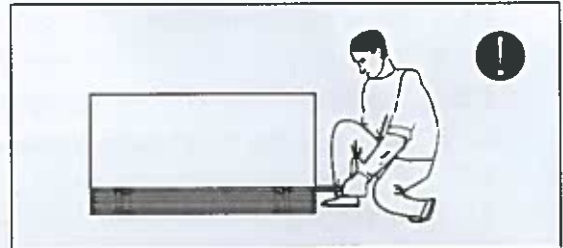

The installation, dismantlement and maintenance of the unit must be performed by qualified personnel. It is forbidden to do any changes to the structure of the unit. Otherwise injury of person or unit damage might happen.

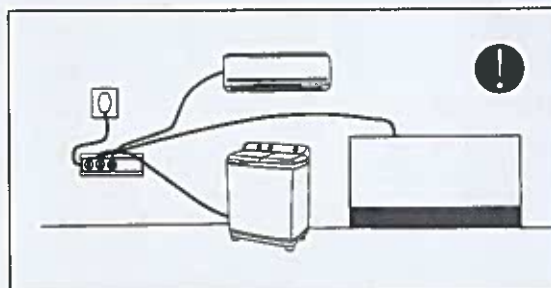

Use a dedicated socket for this unit, otherwise malfunction may occur.

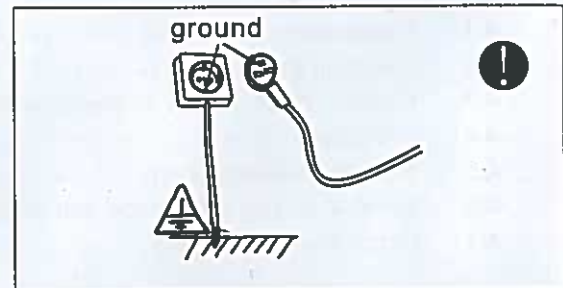

The power supply to the unit must be grounded.



## ▶ 1. Introduction

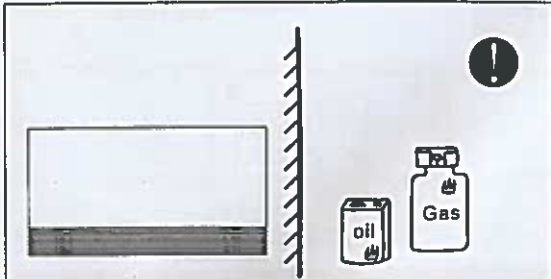

Keep the unit away from the combustible or corrosive environment.



Be sure to read this manual before use.

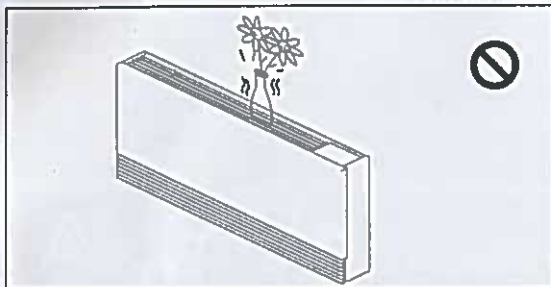

Make sure no water or other liquid drips into the electric box of the unit. Otherwise the unit might be damaged.

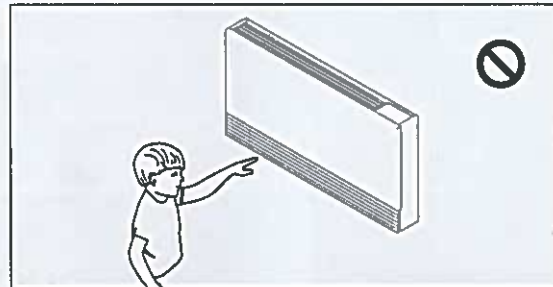

Do not insert any foreign objects into the air outlet grill when the fan motor is running. Otherwise injury of person or unit damage might happen.

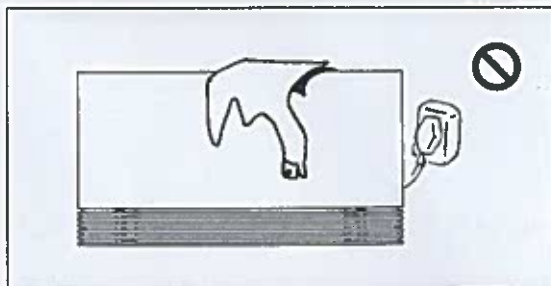

Do not clog air inlet or outlet by paper or any other foreign objects, to keep the unit well ventilated.

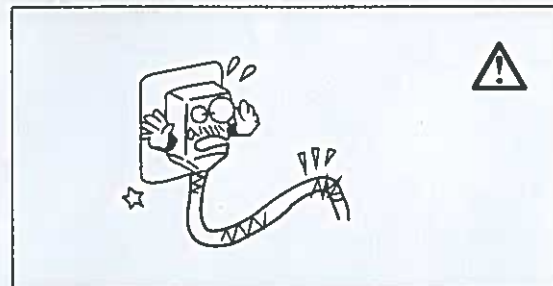

When the power cord gets loose or damaged, always get a qualified person to fix it.

## ▶ 1. Introduction

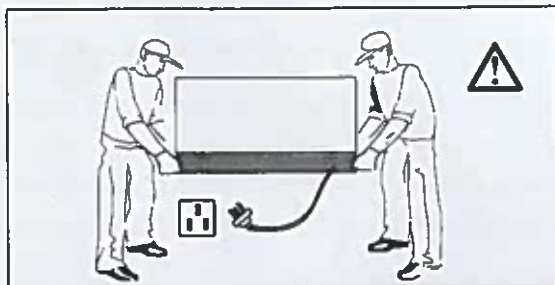

Make sure the power supply to the unit is off before any services are done on the unit.

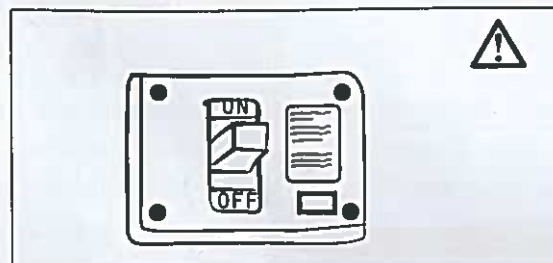

It is mandatory to use a suitable circuit breaker for the unit and make sure the power supply to the unit corresponds to the specifications. Otherwise the unit might be damaged.

1. If the supply cord is damaged, it must be replaced by the manufacturer, its service agent or similarly qualified persons in order to avoid a hazard.
2. This appliance is not intended for use by persons (including children) with reduced physical, sensory or mental capabilities, or lack of experience and knowledge, unless they have been given supervision or instruction concerning use of the appliance by a person responsible for their safety.
3. Children should be supervised to ensure that they do not play with the appliance.
4. The appliance shall be installed in accordance with national wiring regulations
5. The type and ratings of fuse: 522 T3, 15A L250V
6. This marking indicates that this product should not be disposed with other household wastes throughout the EU. To prevent possible harm to the environment or human health from uncontrolled waste disposal, recycle it responsibly to promote the sustainable reuse of material resources. To return your used device, please use the return and collection systems or contact the retailer where the product was purchased. They can take this product for environmental safe recycling.

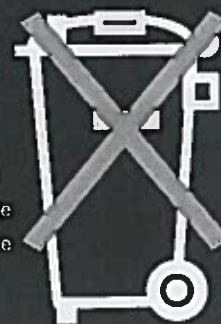



# 1. Introduction

## 1.3 Features

- Unique structure for super slim and super quiet.
- With high efficiency DC fan motor.
- Balanced fan system for super low noise.
- Heat exchanger with hydrophilic coated aluminum coil and inner grooved copper tube, effectively increasing the heat transfer area of this unit.
- Casing in pre-painted galvanized metal sheet, complete with insulation, grilles in high quality aluminium alloy.
- Condensation collection tray with natural drainage, complete with anti-condensation insulation.
- Mesh filter in regenerative polypropylene.

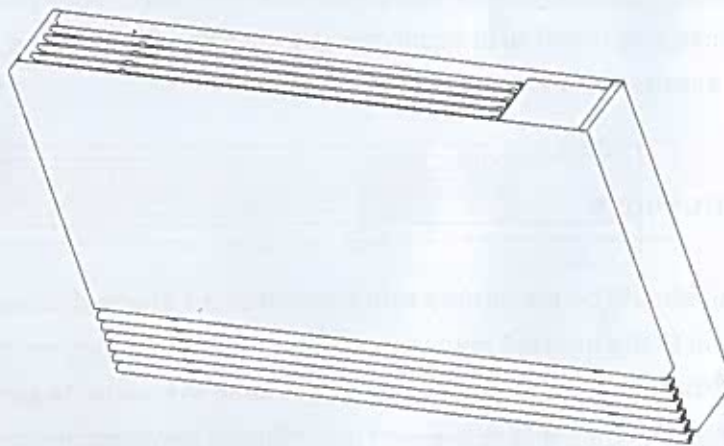

## 1.4 Operation Temperature Range

Operation mode	Room temperature		Water inlet temperature	
	Min	Max	Min	Max
Heating/Cooling	5°C	32°C-60%U.R./R.H.	4°C	80°C

## ► 2. Installation

### 2.1 Transportation and handling



Do not open or tamper with the packaging before installation. The units should only be moved and lifted by specialised personnel trained in these operations. Check on arrival that the unit has not been damaged during transport and that it is complete with all its parts.

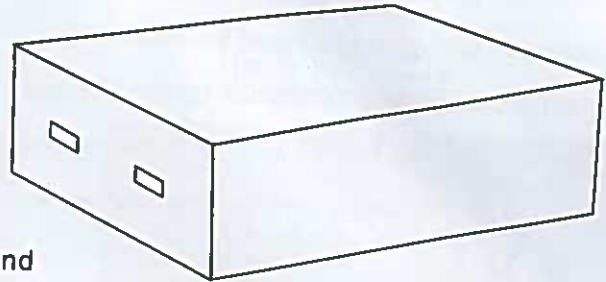

To unpack the unit, follow these instructions:

1. Check for visible damage
2. Open the packaging.
3. Check that all accessories are packed inside the unit.
4. Dispose of the packaging material in accordance with current legislation, at the appropriate waste reception or recycling site.

### 2.2 Handling instructions



Movement of the unit should be performed with care, in order to avoid damage to the external structure and to the internal mechanical and electrical components.

Also make sure that there are no obstacles or people along the route, to avoid the danger of collisions or crushing and to prevent the lifting or handling device from turning over.

All the operations listed below must be carried out in accordance with current health and safety regulations, both as regards the equipment used and as regards the procedure followed. Before commencing moving operations, check that the lifting apparatus has the required capacity for the unit in question.



## ► 2. Installation

### 2.3 Dimensions

The fan coil unit without motorized water valve

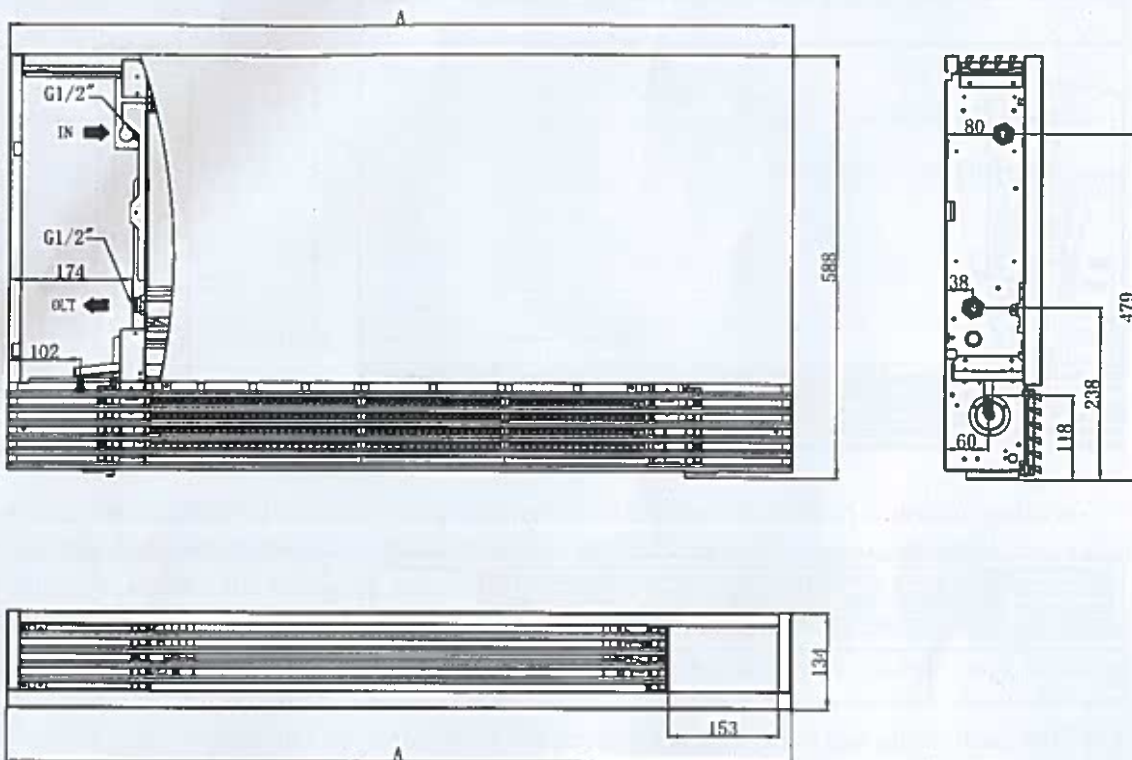

Model no.	A (mm)	Connector size	Net weight (Kg)
MS200DC-V	694	G1/2"	16
MS400DC-V	894	G1/2"	22
MS600DC-V	1094	G1/2"	28
MS800DC-V	1294	G1/2"	32



## ► 2. Installation

The fan coil with three-way valve

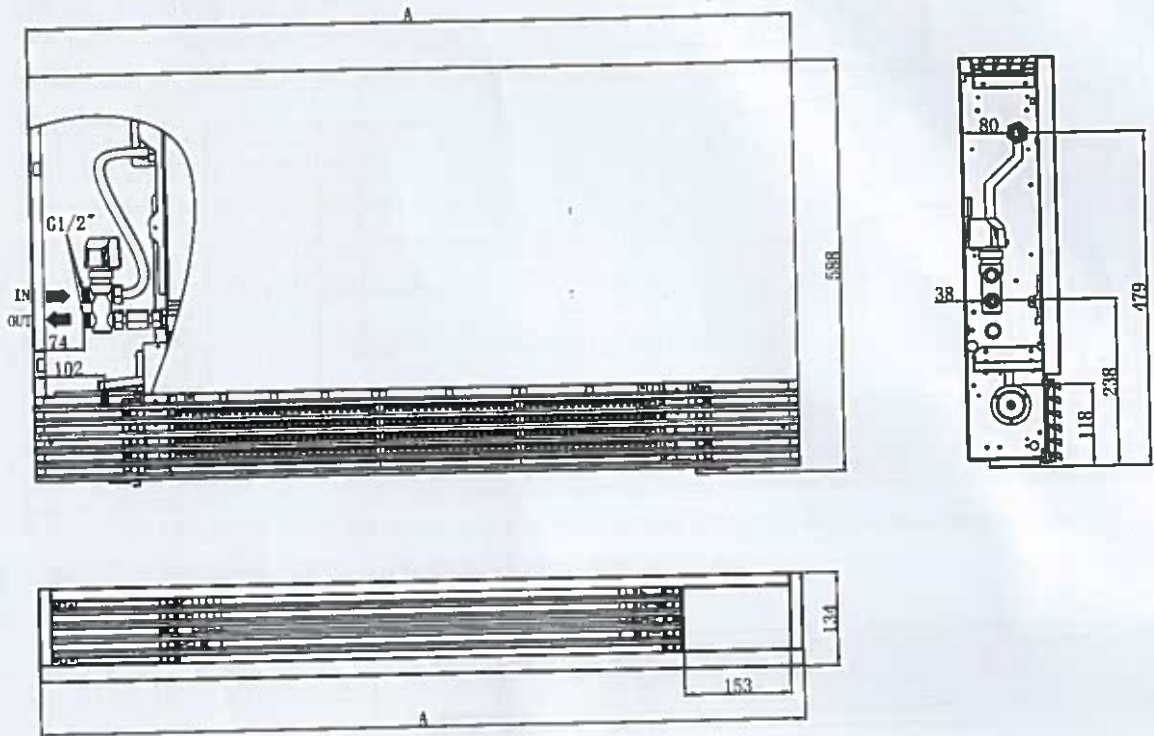

Model	A (mm)	Connector	Net weight (Kg)
MS200DC-V	694	G1/2"	16
MS400DC-V	894	G1/2"	22
MS600DC-V	1094	G1/2"	28
MS800DC-V	1294	G1/2"	32

## ► 2. Installation

### 2.4 Parts description

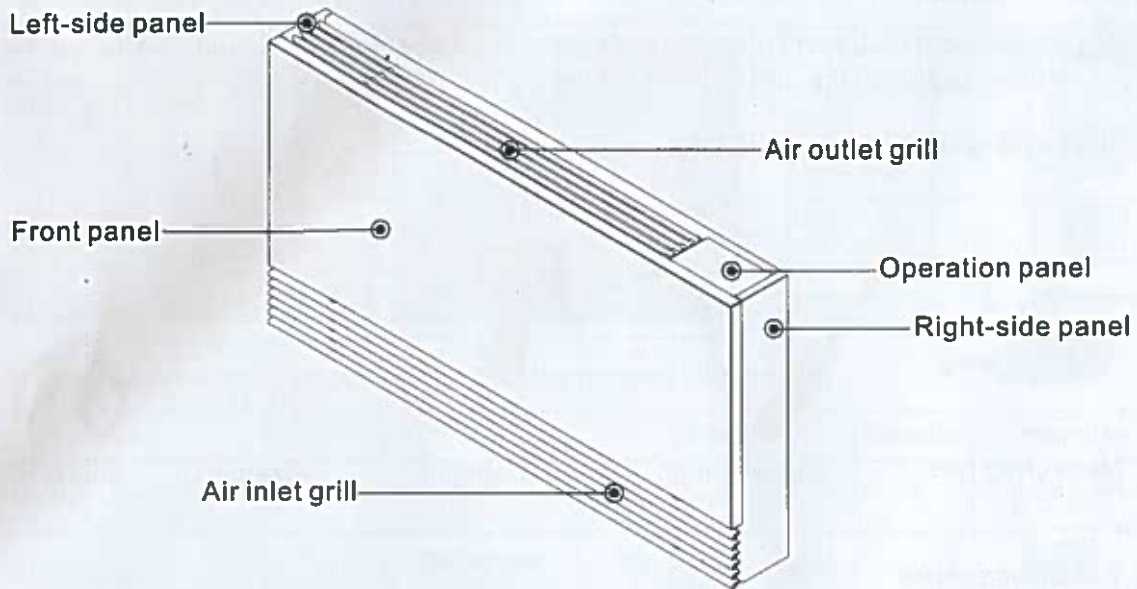

### 2.5 Unit Installation

Unit can be installed on the floor (only for the model with feet included) to obtain optimum efficiency and performance. In order to prevent any failures or hazardous situation, the installation location must meet the following requirements:

- For floor installation, the minimum clearance is 80mm between the floor and the bottom of the unit, 20mm from unit side to the wall for easy removal of side panels, and 140mm around the air inlets and outlets.
- The wall must be sturdy and capable of supporting the weight of the appliance, and the air inlet from the unit must be 400mm clear of any other objects.

#### Location of the unit

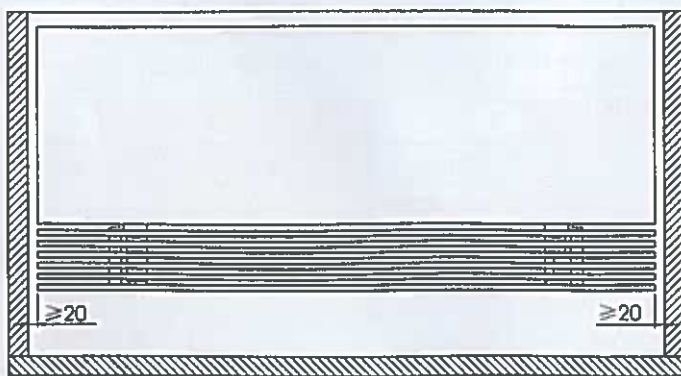

Front view for vertical mounting

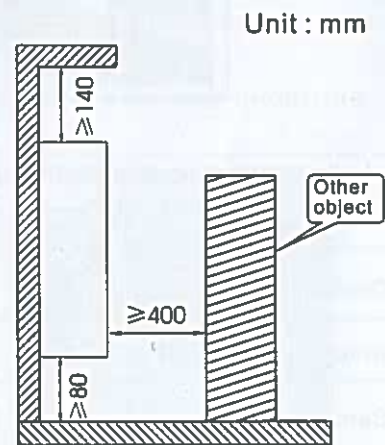

Wall mounting

Unit : mm

## ► 2. Installation

### 2.6 Precautions:

- ⚠ Installation of the unit must be performed by professional and qualified installers.  
Power supply to the unit must be off before installation or maintenance work starts.

### Necessary tool for installation







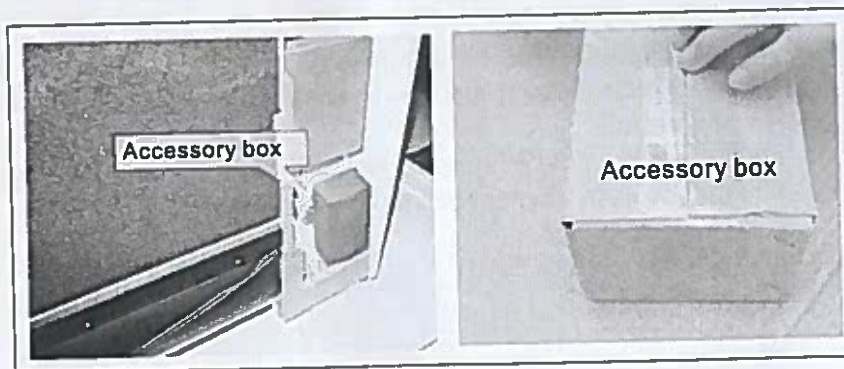

### 2.7 Accessories

(1) For the models with feet included only:

Take out the accessory box as shown in below pictures:



List of accessories included in accessory box:

Name	Quantity	Remark	Name	Quantity	Remark
Gasket	1		Machinery screw + Flat ring	2	
Screws (ST4. 1X10)	4		Expansion bolt	4	
Sensor fixture	1		Sealing gasket	2	



## 2. Installation

(2) Take out the accessory bag from the place as shown in below pictures (for all models):

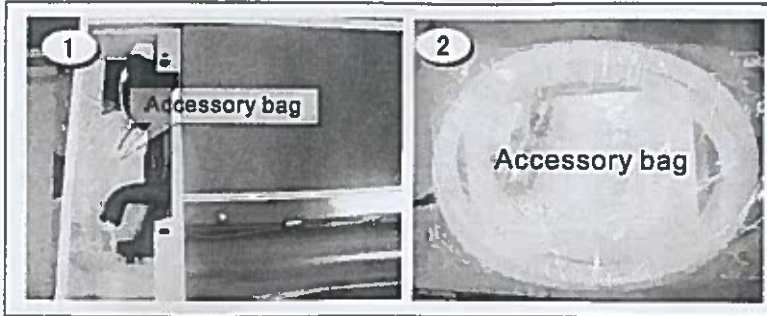

Accessories included in accessory bag for the models with feet included:

Name	Quantity	Remark
Positioning board	1	
Drain pipe	1	
User manual	1	
Ribbon	2	

Accessories included in accessory bag for the models without feet

Name	Quantity	Remark	Name	Quantity	Remark
User manual	1		Drain pipe	1	
Ribbon	2		Plastic hose clamp	1	
Expansion bolts	4		Sealing gasket	2	
Machinery screw	2		Spring washer	2	
Gasket	1		Screws	4	
Sensor fixture	1		Positioning board	1	

### 2.8 Installation

#### 2.8.1 Before installation

Before installation, left-side panel and right-side panel need to be taken off. Use a screw driver to take off two screws under the left side of the air outlet grill, and then pull to take out the left-side panel.

Press operation panel on right side of the machine, unscrew two screws under the operation panel, to take out the right-side panel.

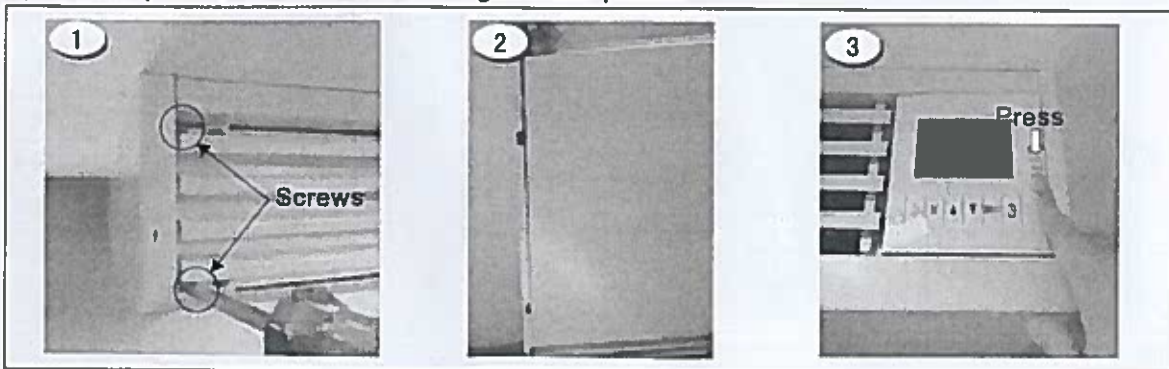



## ► 2. Installation

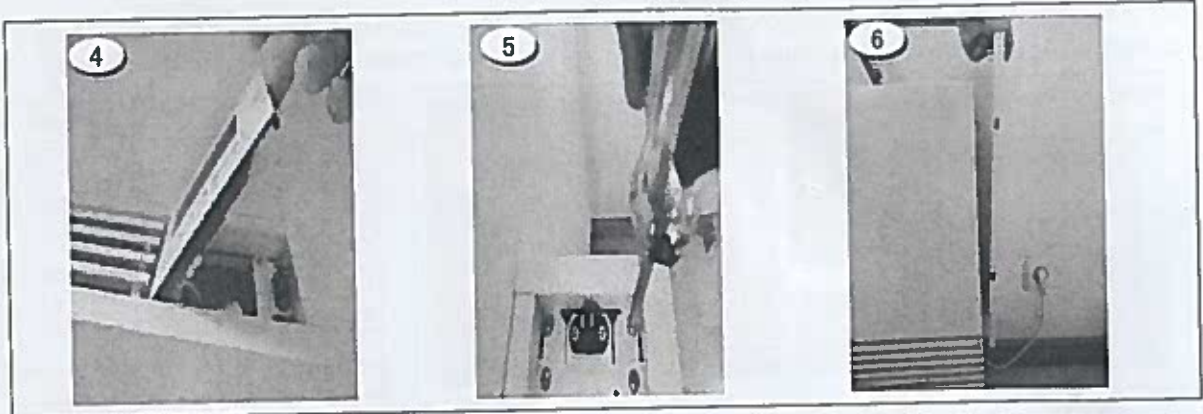

### 2.8.2 Take off the air outlet grill

Take off one screw on each side of the air outlet grill, and take out the air outlet grill.

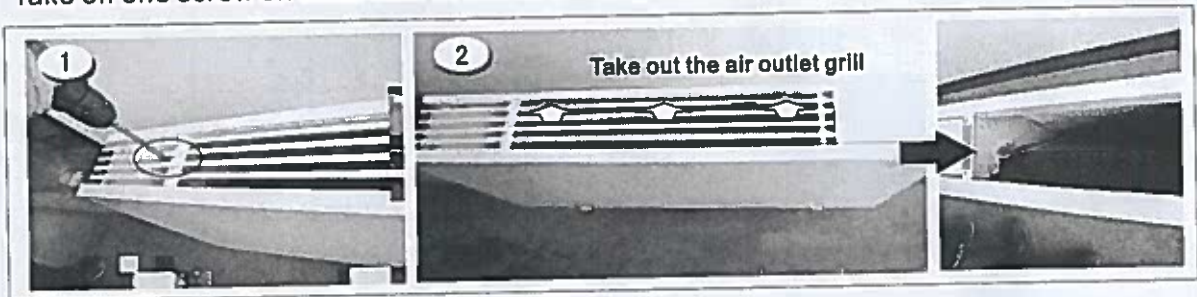

### 2.8.3 Wall mounted installation

Take out the positioning board from accessory. Please put the positioning board up against the wall.

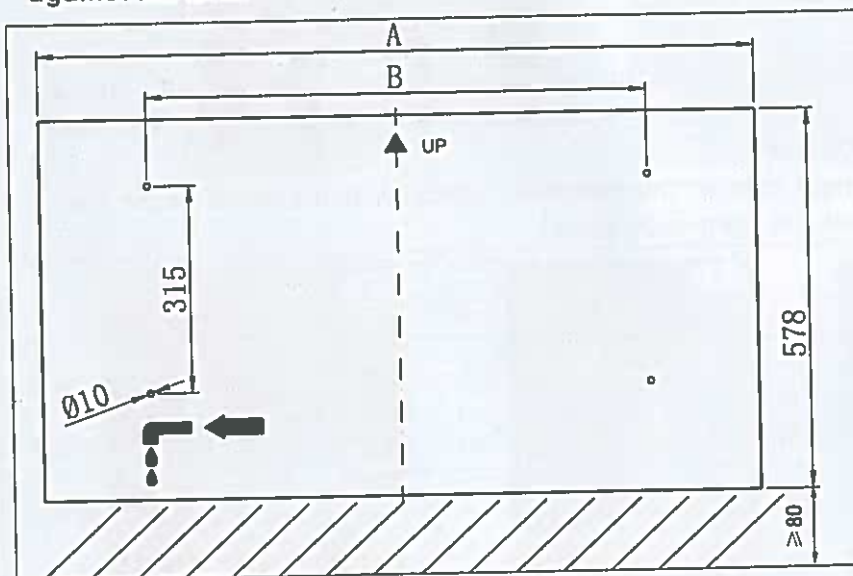

Cardboard

Unit : mm

MS200DC-V	1294	964
MS400DC-V	1094	764
MS600DC-V	794	564
MS800DC-V	594	364
Model	A	B

## ► 2. Installation

1. After a suitable place for installation is selected, the unit must be fastened to the wall in place by two expansion bolts in each side. To fasten the unit to a wooden wall, use suitable bolts.
2. Mark on the wall where the mounting holes will be drilled. Drill the wall with a power drill. Put the  $\phi 8$  expansion bolts in the holes, mount the gasket on expansion bolt to avoid the touching between unit and wall.
3. Mount the unit on the expansion bolts (refer fig. 3) and position the unit properly using a level, so that it slightly tilt to the area of water discharge for good condensate drainage.

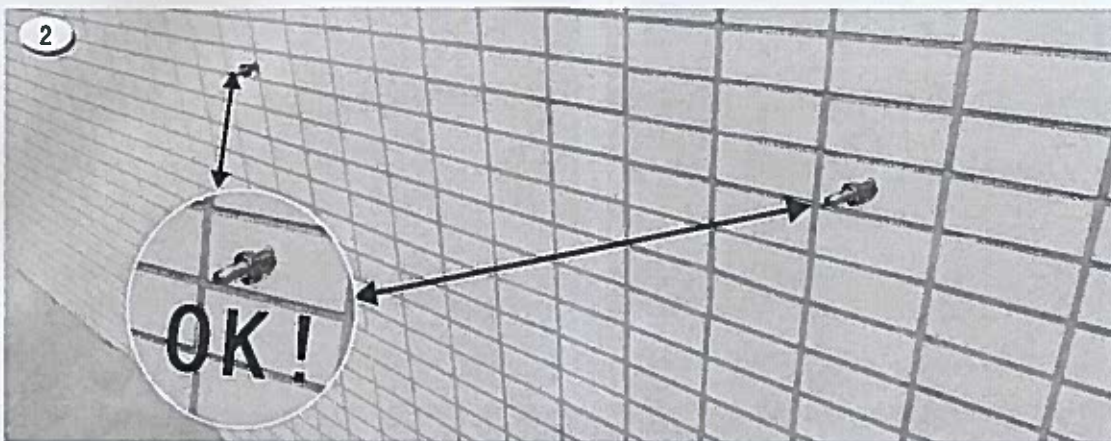



## ► 2. Installation

1. After a suitable place for installation is selected, the unit must be fastened to the wall in place by two expansion bolts in each side. To fasten the unit to a wooden wall, use suitable bolts.
2. Mark on the wall where the mounting holes will be drilled. Drill the wall with a power drill. Put the  $\phi 8$  expansion bolts in the holes, mount the gasket on expansion bolt to avoid the touching between unit and wall.
3. Mount the unit on the expansion bolts (refer fig. 3) and position the unit properly using a level, so that it slightly tilt to the area of water discharge for good condensate drainage.

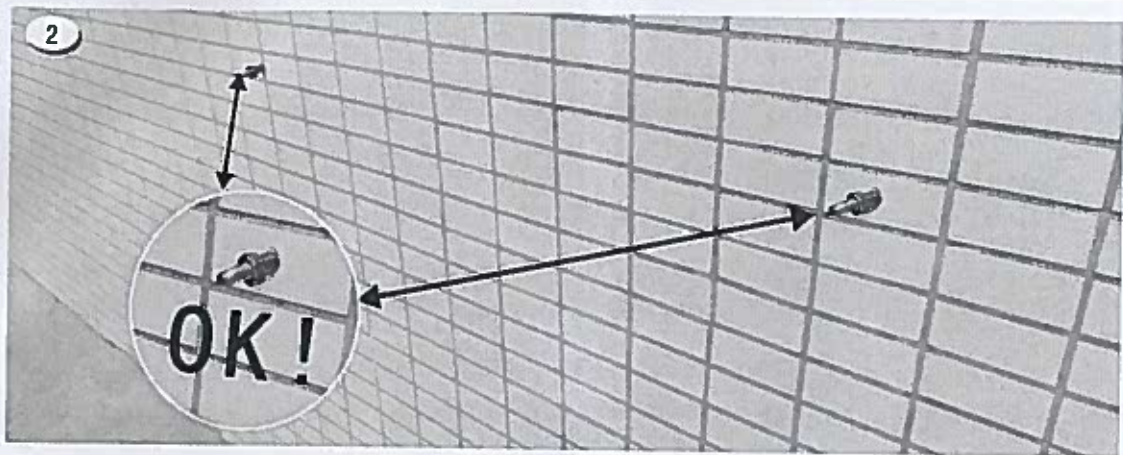

## ► 2. Installation

### 2.8.4 Installation of feet (for the models with feet included only)

Fix the feet onto the unit by fastening the screws on two sides of feet. After a suitable place is selected, put the unit against the wall, fasten expansion bolts on left and right side of back panel to fix the unit on the wall. Mount the gasket on expansion bolt to avoid the touching between unit and wall.

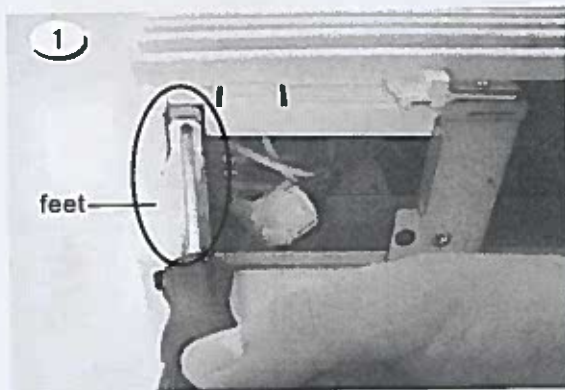

### Installation of baffle plate for feet

Please insert the baffle plate into the feet after water connection is finished (See chapter 2.8.4). The depth for inserting the baffle plate into the feet can be adjusted according to the thickness of base board, so that the baffle plate can be close to base board.

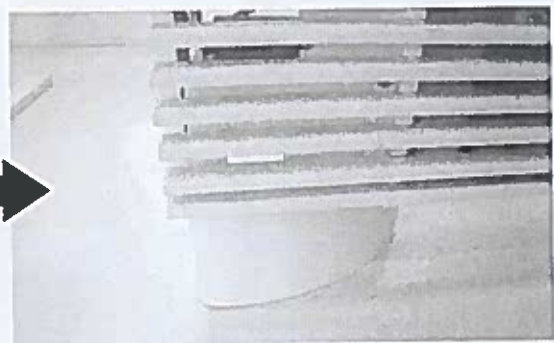
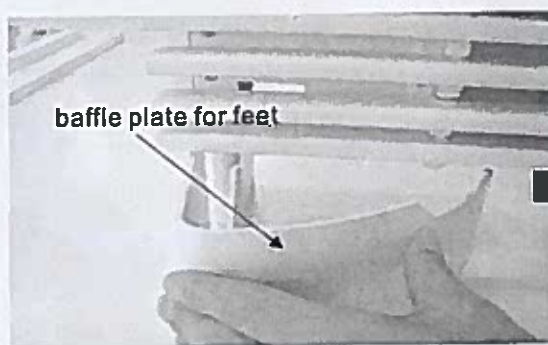



## ► 2. Installation

### 2.8.5 Water pipe connection

Note: the water pipe mustn't stick out beyond the range of side panel, otherwise the side panel can't be installed back.

After the unit is installed in place, connect water inlet and outlet pipes according to the stickers on the unit. Please refer to local safety requirements for safety purpose. After installation, please check the leakage, clean the unit etc, to meet the local regulations before usage.

For the models with 4 connectors 3-way valve:

Water pipes passing through the wall

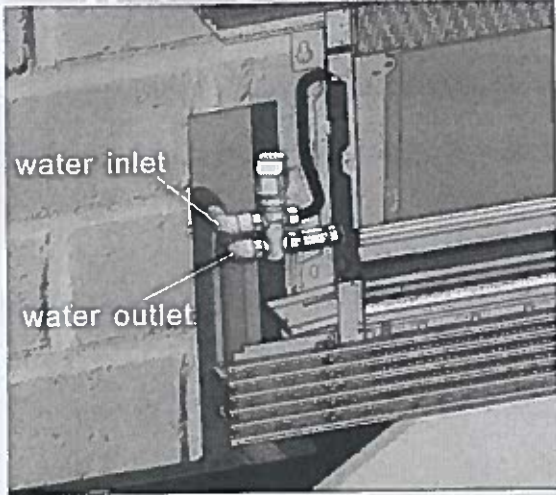

Water pipes passing through the ground

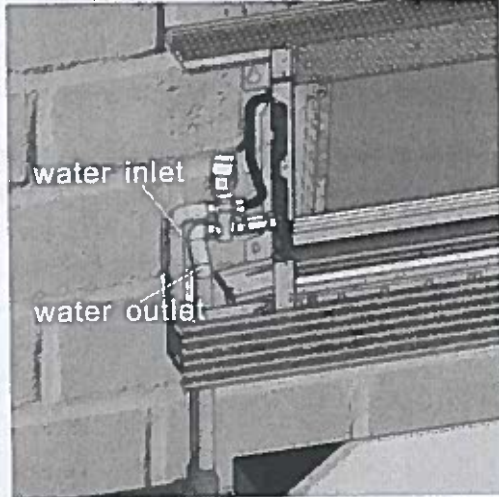

For the models with 3 connectors 3-way valve:

Water pipes passing through the wall

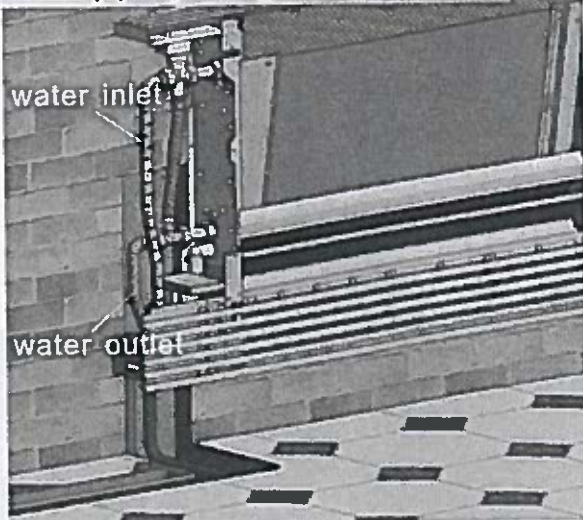

Water pipes passing through the ground

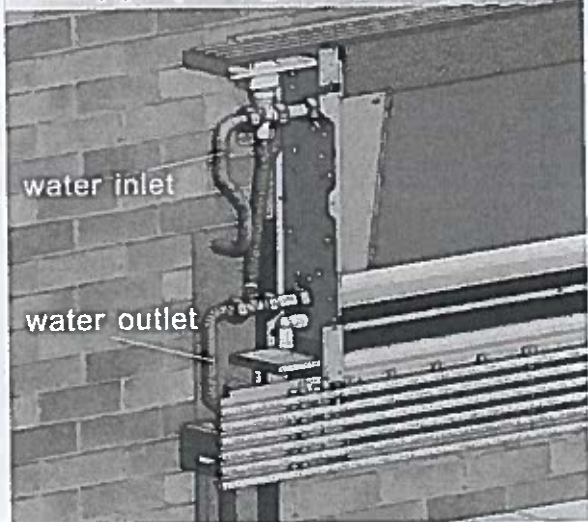

## ► 2. Installation

Installation steps:

For the models with 4 connectors 3-way valve:

1. Take off the sealing cover of water inlet/outlet pipe .

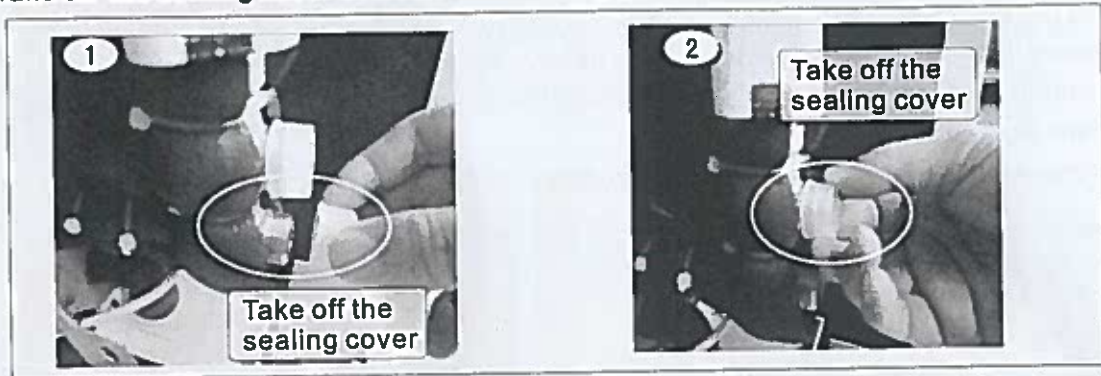

2. Connect the unit to water system, Stainless steel corrugated pipe are recommended for the inlet/outlet water pipe. Choose the water pipe in proper length to connect the unit to water system.

Note: The gasket seal must be put on the connector jointing, then fasten the screws nuts by spanner , to make sure there is no leakage in the joint.

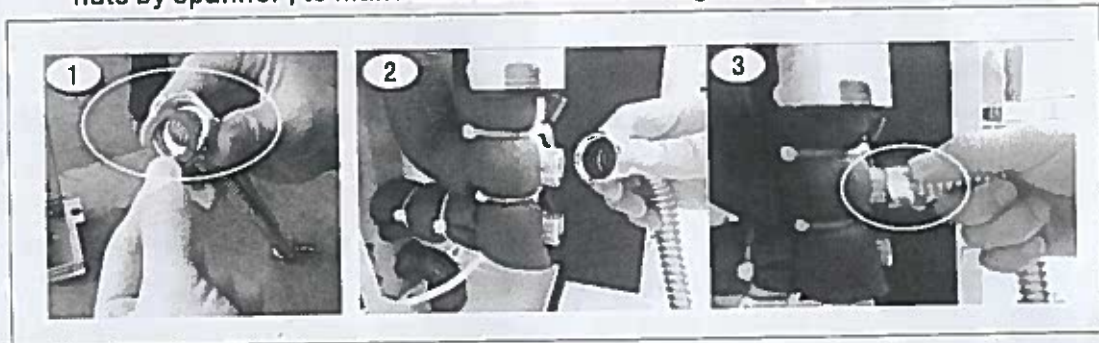

Note: To connect the water inlet/outlet of the unit to water pipe, it's necessary to use a spanner to fix the water inlet/outlet, and use another spanner to screw up the connector of water pipe into the water inlet/outlet. Don't use only one spanner to do this operation, otherwise the water pipe of the unit would be damaged by turning round.

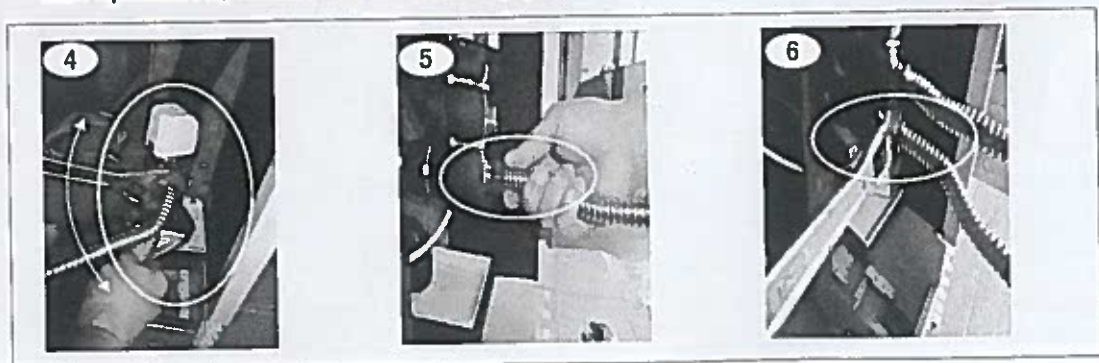



## ► 2. Installation

### Installation steps:

For the models with 3 connectors 3-way valve:

1. Take off the sealing cover or water inlet/outlet pipe .



2. Connect the unit to water system, Stainless steel corrugated pipe is recommended for the inlet/outlet water pipe. Choose the water pipe in proper length to connect the unit to water system.

Note: The gasket seal must be put on the connector jointing, then fasten the screws nuts by spanner , to make sure there is no leakage in the joint.

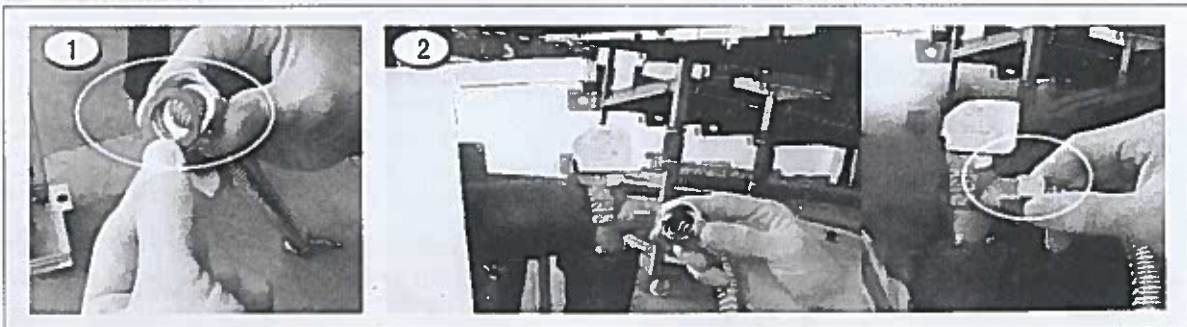

Note: To connect the water inlet/outlet of the unit to water pipe, it's necessary to use a spanner to fix the water inlet/outlet, and use another spanner to screw up the connector of water pipe into the water inlet/outlet. Don't use only one spanner to do this operation, otherwise the water pipe of the unit would be damaged by turning round.



## ► 2. Installation

3. Connect the smaller end of drainpipe to the outfall of auxiliary drain pan, then fasten the jointing by a tie.

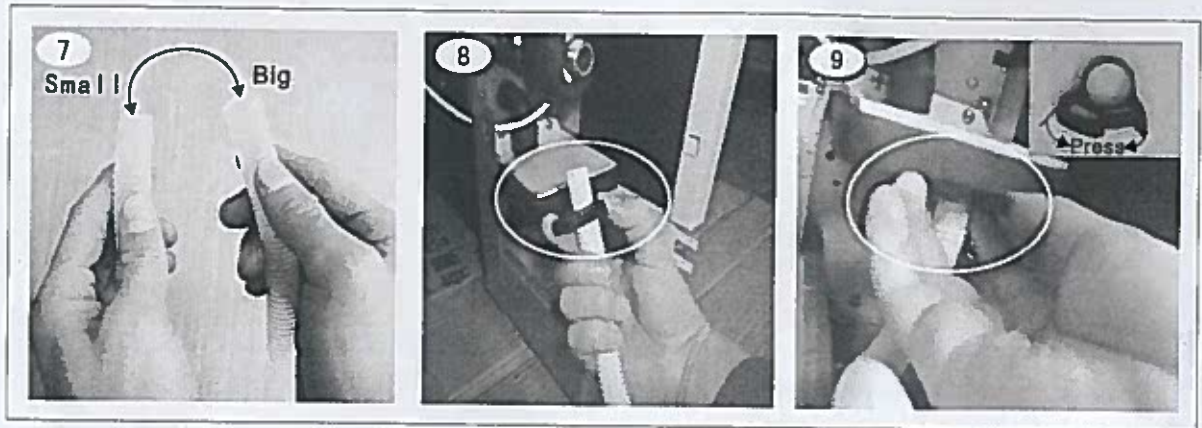

### 2.8.6 Filter

▼ It's suggested that a 80 mesh filter be installed before the water inlet of the unit, for keeping the water quality and collecting impurity contained in the water. Make sure to keep the water filter mesh downwards. Check valve is recommended so that the filter can be cleaned or changed in an easier way.

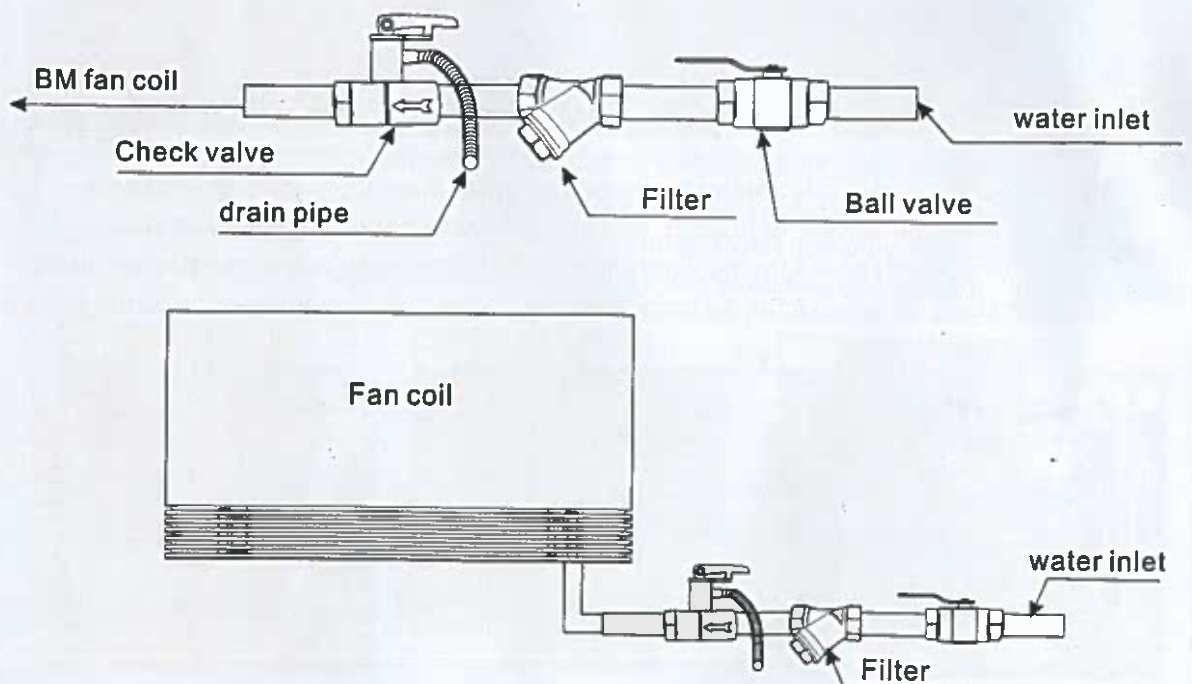



## ► 2. Installation

### 2.8.7 Insulation

All the water piping must be insulated with insulation no less than 9mm thick. But all the valve switches need to stay outside for future use. The insulation must be fastened by tape, without any gap.



### 2.8.8 Setting up the condensate drainage system

The condensate drainage system must be set up with an adequate decline, to ensure the water drain away properly. Following are directions for setting up a proper condensate drainage system:

**Notice:** To check if water flow is in correct direction, it's recommended to pour some water into the drain pan very slowly. If the water can't drain away smoothly, some adjustments should be made.

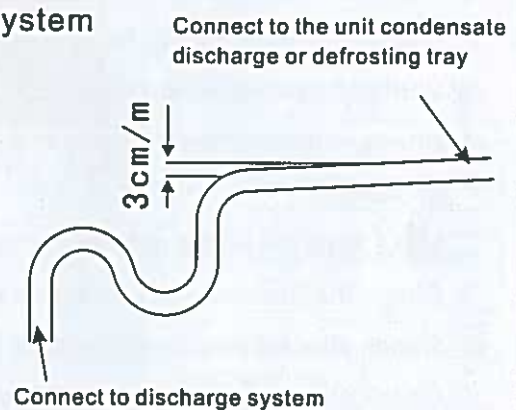

## 2.9 Test-run

### 2.9.1 Air purging

After finishing the installation, proceed with the following steps to discharge the air in the unit:

- ①. Take out the air outlet grille
- ②. Open all valves of water system to have water flow into the unit.
- ③. Open air purging valve, and check the water in a transparent pipe connected with the valve. If the transparent pipe is filled with water without any bubbles, the air is completely purged from the coil. Then close the purging valve.

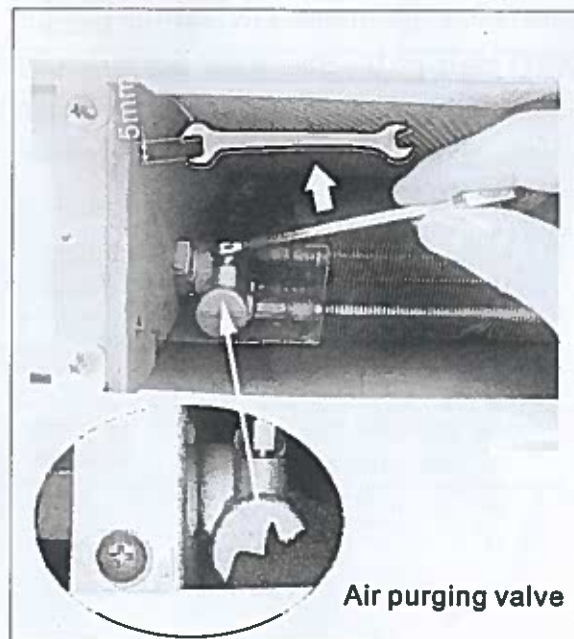

## **2. Installation**

### **2.9.2 Pre Start-up**

Before starting up the unit, a certain number of verifications must be performed on the installation to ensure that the unit will operate under the best possible conditions.

The check list below is not exhaustive and should only be used as a minimum reference basis:

- ①. Make sure fan rotates freely.
- ②. Inspect all water piping for flow direction.
- ③. Verify all system piping is correct for operation as per installation requirement.
- ④. Check voltage of the unit power supply and make certain voltage is within authorized limitations.
- ⑤. Make sure the unit is properly grounded.
- ⑥. Check the presence of protective and breaking devices.
- ⑦. Check all electric connections for tightness.
- ⑧. Check all piping for leaks and air is well ventilated.

### **2.9.3 Unit Start-up**

After ensuring all electric connections confirm to the local regulations, follow the Operation Instructions to start-up the unit.

After start-up the unit, if there is an abnormal sound, please shut off the power supply immediately to ensure the safety of the unit.

## ▶ 3. Operation Instructions

### 3.1 Operation panel

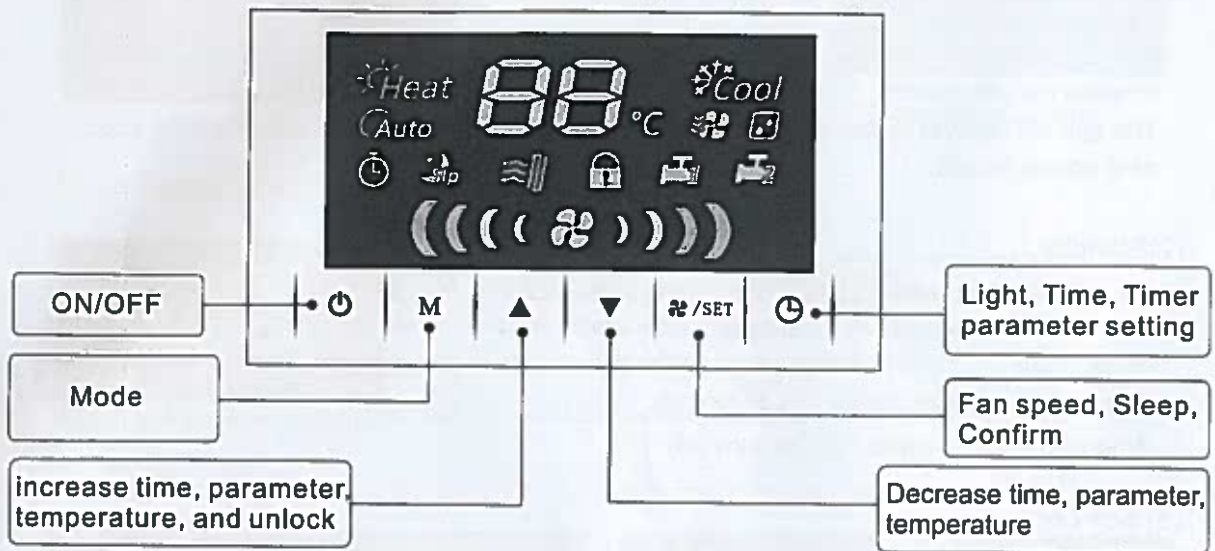

Symbol	Meaning	Symbol	Meaning
	Heating mode		Timer
	Cooling mode		Electrical heater
	Auto mode		Sleeping mode
	Dry mode		Key lock
	Fan mode		Fan speed
	Water valve1 and2		Air Inlet Temperature and Setting Temperature



## ▶ 3. Operation Instructions

### 3.1 Operation panel

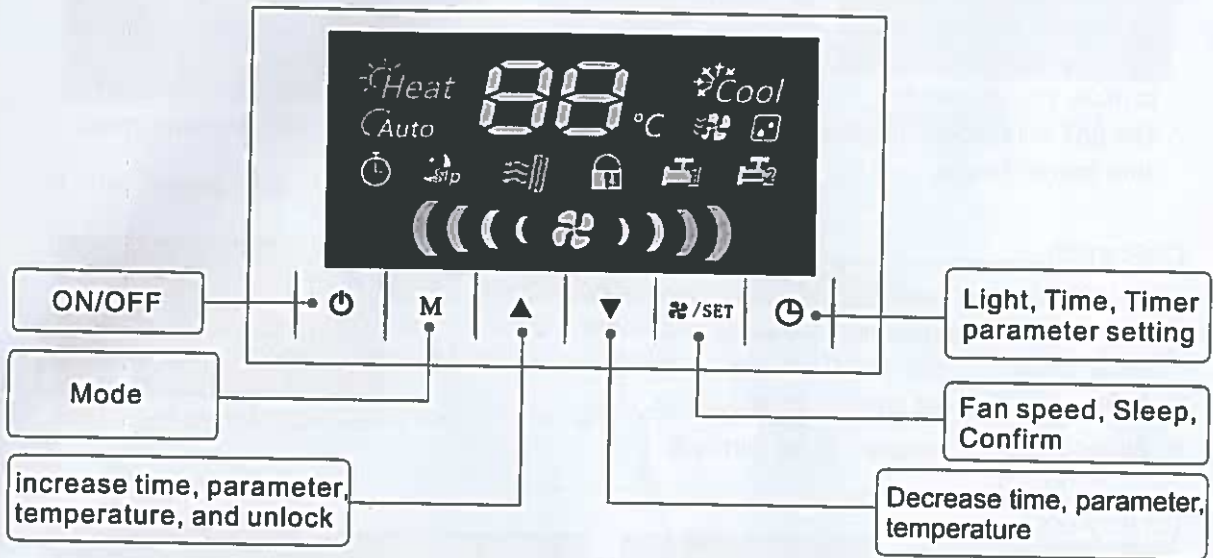



Symbol	Meaning	Symbol	Meaning
	Heating mode		Timer
	Cooling mode		Electrical heater
	Auto mode		Sleeping mode
	Dry mode		Key lock
	Fan mode		Fan speed
	Water valve 1 and 2		Air Inlet Temperature and Setting Temperature

## ▶ 3. Operation Instructions

### 3.2 Operation Instructions

#### (1) ON/OFF

● When the unit is standby, press  3 seconds to turn on the unit.

When the unit is working, press  again for 3 seconds to make the unit standby.

The unit will recover its latest working settings automatically after power failure.



ON with Heating mode

#### (2) Standby

● The following two conditions are called standby, the unit does not work when standby, but only shows the room temperature.

1. Power on → but not press  to turn on.



2. When working → press  to turn off.



Standby with no Key lock

#### (3) Key Lock

● The touchpad will automatically be locked if there is no operation for 30 seconds when the unit is turned on. When the touchpad is under key lock,  will be shown on the screen and the unit will not response for any operation on the touchpad.





Press the  button for 3 seconds until the  disappears on the screen to unlock the touchpad.



ON with Heating mode and Key lock

#### (4) Mode Selection

● When the unit is turned on and at main interface, press  to choose the operation mode. It comes in the sequence:



Heating mode , Cooling mode , Dry mode , Fan mode , Auto mode .

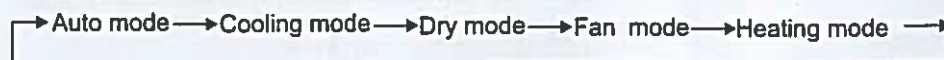

Mode Selection



#### (5) Sleeping Mode

Press  button for 3 seconds to select or quit sleeping mode. When the sleeping is selected,  will be displayed on the screen.

When sleep function is activated, unit will reduce (in heating operation) or increase (in cooling operation) the set temperature by 2°C for a comfort sleep. It will quit automatically after 8 hours. This setting is valid only once.





## ▶ 3. Operation Instructions

### ☞ Timer Unsetting









Pressing  button and set the timer to zero to cancel the timer.

### (9) Self-checking

Press  two times within 3 seconds after power the unit, unit will enter into self-checking mode. It will power water valve 1 (EV1) and valve 2(EV2) in sequence.

Unit will quit self-checking function automatically in 10 seconds. But unit will only recover to standard working mode after repower the unit.

### (10) Parameters Setting

● Press  and  at the same time to enter the parameters setting when the unit is standby. The screen will display the twinkling serial number  of the parameters after entering the parameters setting. Press  and  to select and press  confirm the serial number of parameter you want to change and set the corresponding parameter with  and . The system will be back automatically to the serial number setting if there is no instruction in 10 seconds after setting the parameter and will quit the parameters setting if there is no instruction in 10 seconds. In order to save and back, press  after setting a parameter or serial number.

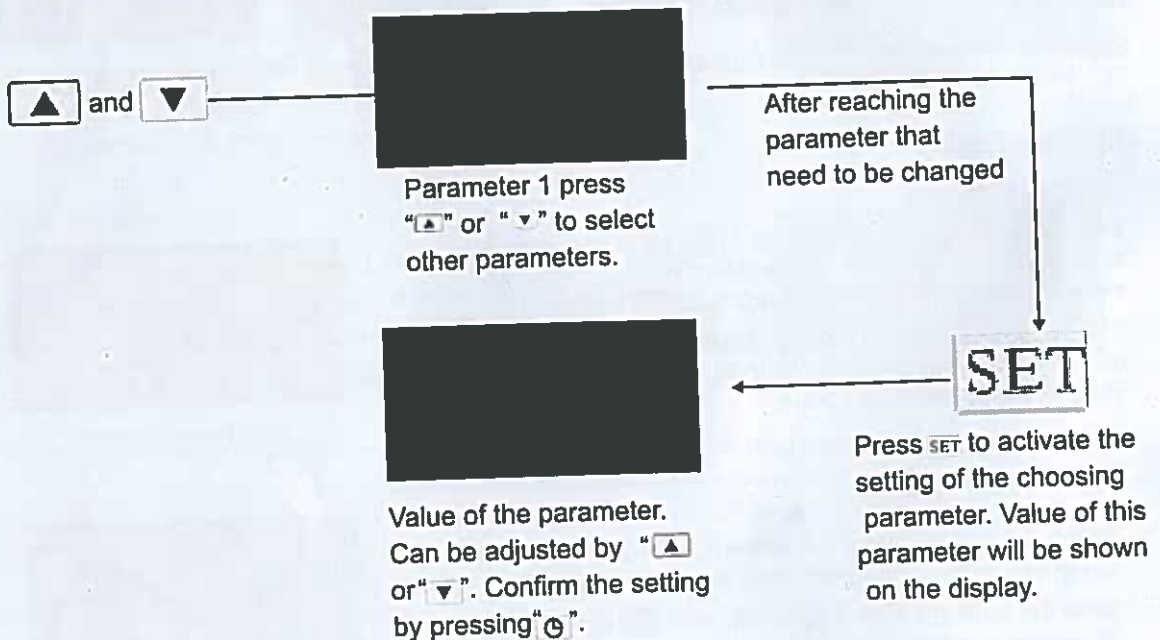

## ▶ 3. Operation Instructions

### (11) Parameters

Serial Number	Meaning	Range	Default Setting
1	High fan speed of cooling	12-15	14
2	Medium fan speed of cooling	10-13	12
3	Low fan speed of cooling	8-12	10
4	High fan speed of heating	10-15	12
5	Medium fan speed of heating	8-12	10
6	Low fan speed of heating	5-10	7
7	Super low fan speed of heating	4-8	5
8	Valve functions	0 (OFF) , 1 (ON)	1
9	485 communication	0 (OFF) , 1 (ON)	0

Ps: Actual fan speed = Setting fan speed \* 100

### (12) Failure code

Failure code will flash on the display. Multiple failure code will come in sequence on the display

Serial Number	Possible causes	Error Code Displayed
1	Air inlet temperature sensor failure	E1
2	Water inlet temperature sensor failure	E2
3	DC motor failure	E3
4	Wired controller temperature sensor failure	E4 (parameter 9 valid)
5	Wired controller humidity sensor failure	E5 (parameter 9 valid)
6	Bottom wired controller communication failure	E6
7	485 wired controller communication failure	E7 (parameter 9 valid)

Failure code shows up when:

1. Air inlet temperature sensor failure: Cancel room temperature control, the error code shows up.
2. Water inlet temperature sensor failure: Cancel water inlet temperature limit, the error code shows.
3. DC motor failure: The unit stops running, the error code shows up.
4. Wired controller temperature sensor failure: Cancel room temperature control, the error code shows.
5. Wired controller humidity sensor failure: It only shows the error code.
6. Bottom wired controller communication failure: It only shows the error code.
7. 485 wired controller communication failure: The unit stops running, the error code shows up.

## ► 4. Maintenance

### 4.1 Precautions

- It is forbidden to change the inner structure and wiring of the unit. Otherwise injury of person or unit damage might happen.
- If the unit fails to work properly, please cut off the power supply immediately. The maintenance work must be performed by qualified personnel.
- "Failure code" in this manual is helpful to find out and fix the failure of the unit.
- In cold weather, if the unit is not run for a long time, do drain out the water inside the system.
- Occasionally check the surrounding, stability and airflow of the unit.
- The filter must be cleaned occasionally to ensure the water flow of the water system

### 4.2 Cleaning the air filter

To ensure the correct air intake, the air filter must be cleaned once a month, or more frequently if the unit is being used in very dusty environment.

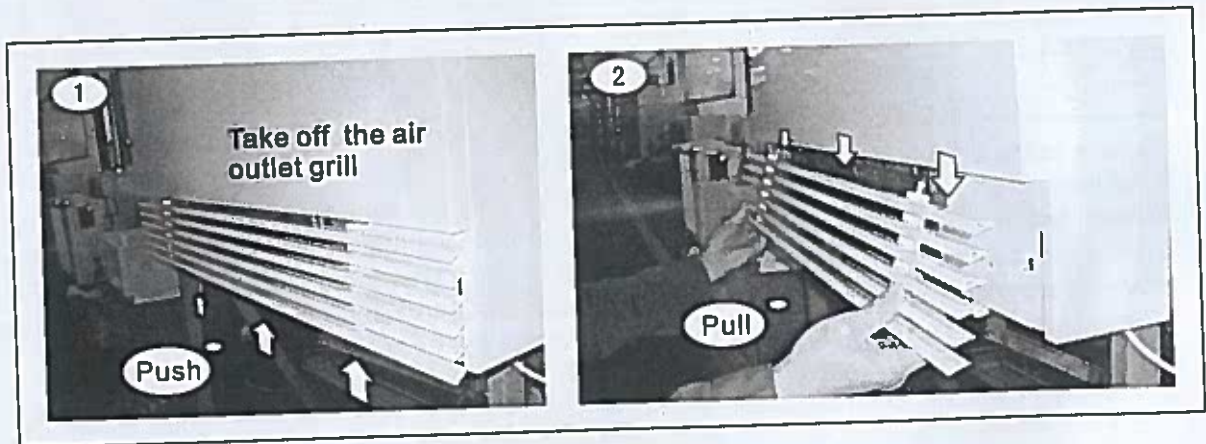

To take off the filters, pull them towards you. Filters are cleaned by removing any impurities from their surface with a vacuum-cleaner; then wash them with a mild detergent and plenty of warm water, rinse them thoroughly and dry before re-assembly. Filters must be re-fitted by introducing the end of the shorter side into the plastic guide positioned under the fan. please refer fig.4.



## ► 4. Maintenance

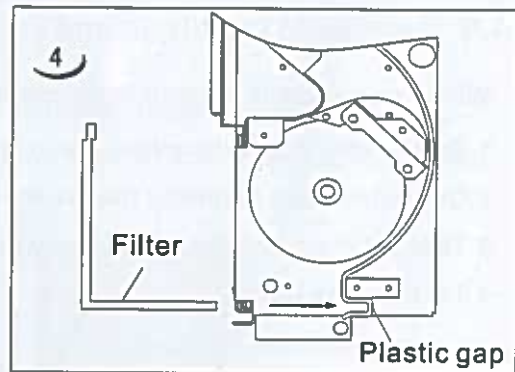
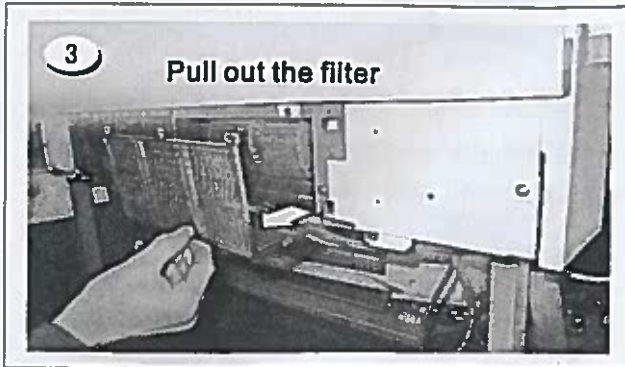

### 4.3 Check and clean the air inside water system occasionally

It is suggested to check and clean the air inside water system occasionally, to ensure the performance of the unit.

Please do air purging work as per 2.9.1

### 4.4 Drainage

Please drain out the water in the system, if the unit is not run for a long time.

Occasionally check whether there is air in the water system. If yes, purge it out as per instruction in chapter 3.

### 4.5 Service to electric parts

If any service to electric parts is required, please refer to part 2.8 to take out the right side panel to get access to electric box.



## ► 4. Maintenance

### 4.6 Service to fan blade and fan motor

When fan system is not working properly, please open right side panel.

1. Take off the right side panel, open the electric box, pull out the connector of the motor.
2. Use a Allen key to unlock the fan blade with fan motor.
3. Take off the screw for fan motor fixture .
4. Take out the fan blade or fan motor.

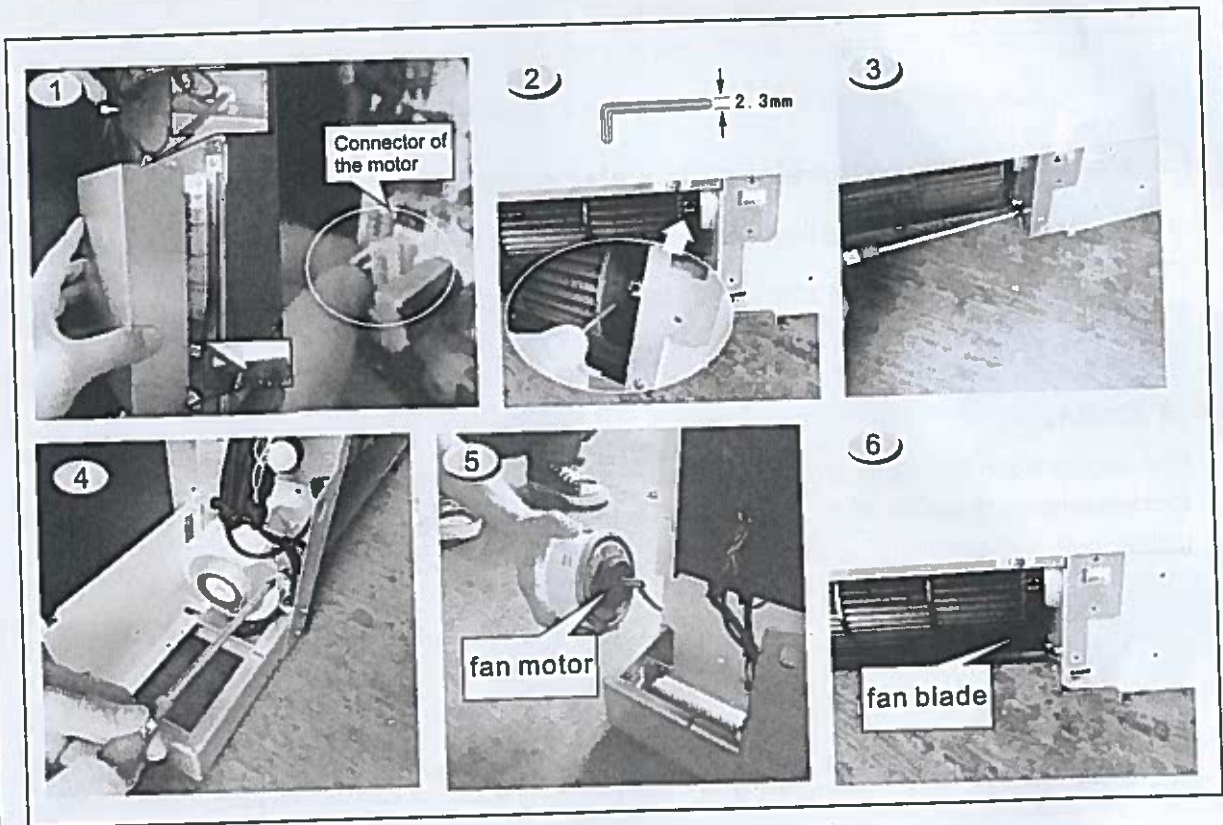

## ► 4. Maintenance

### 4.7 Circuit board changing

#### 【Take off the circuit board】

1. Cut off the power supply of the fan coil unit, take off the right side panel of the unit.
2. Take off the screws at the top and bottom side of the electric box with a screw driver, open the cover of the electric box.



3. Unplug the motor connector, power supply connector, electrical three-way valve connector, wired controller connector, air inlet temperature sensor connector and water inlet temperature sensor connector on the circuit board.

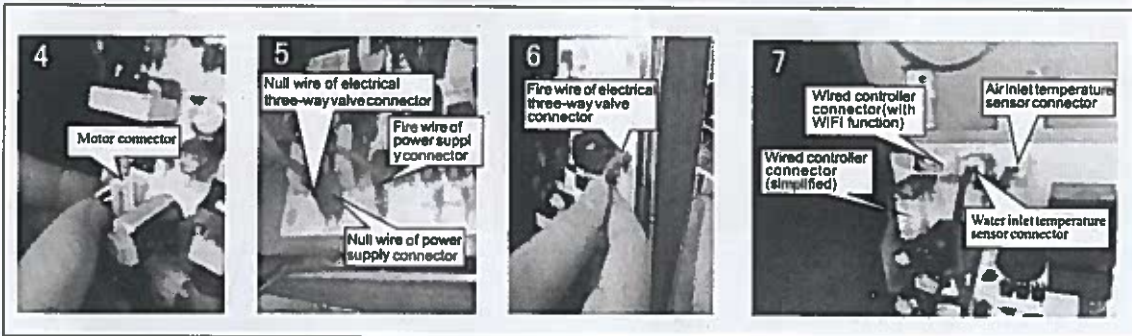

4. Unbolt the four plastic screws on the circuit board with a screw driver and take off the circuit board.

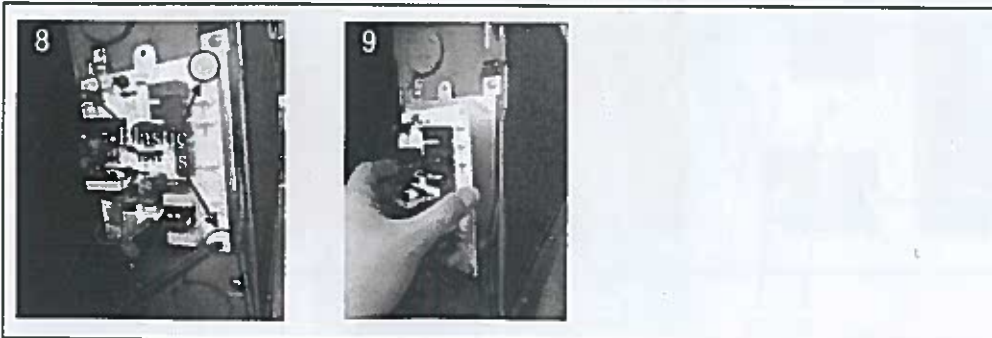



## ► 4. Maintenance

**【Install a new circuit board】**

1. Put on a new circuit board and fix the circuit board with the four plastic screws.



2. Plug the motor connector, power supply connector, electrical three-way valve connector, wired controller connector, air inlet temperature sensor connector and water inlet temperature sensor connector on the circuit board.

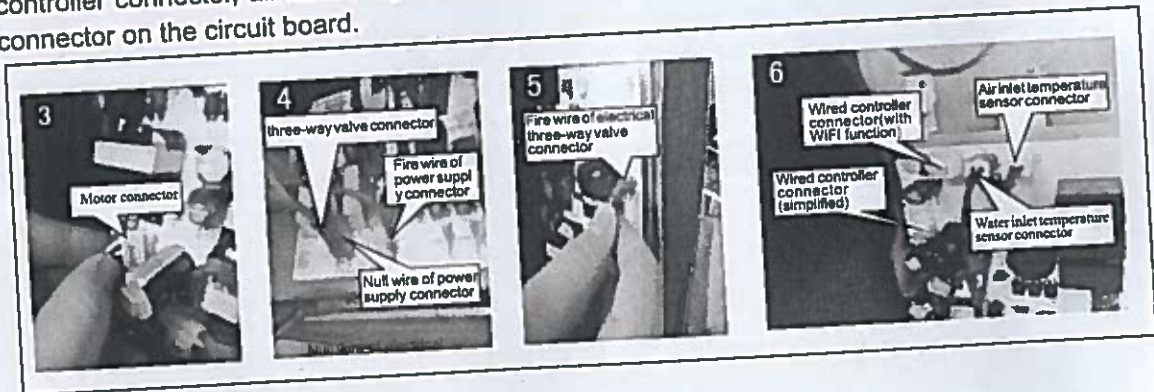

3. Put on the cover of the electric box

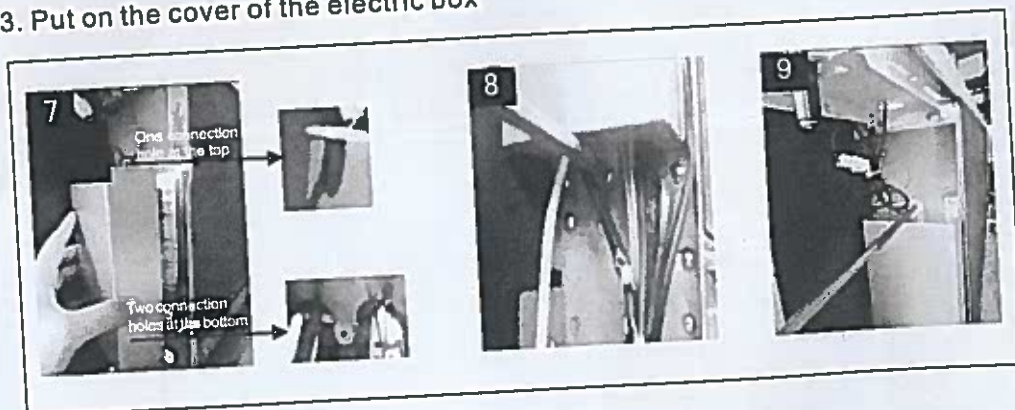

# ► 5. Appendix

## 5.1 Exploded view

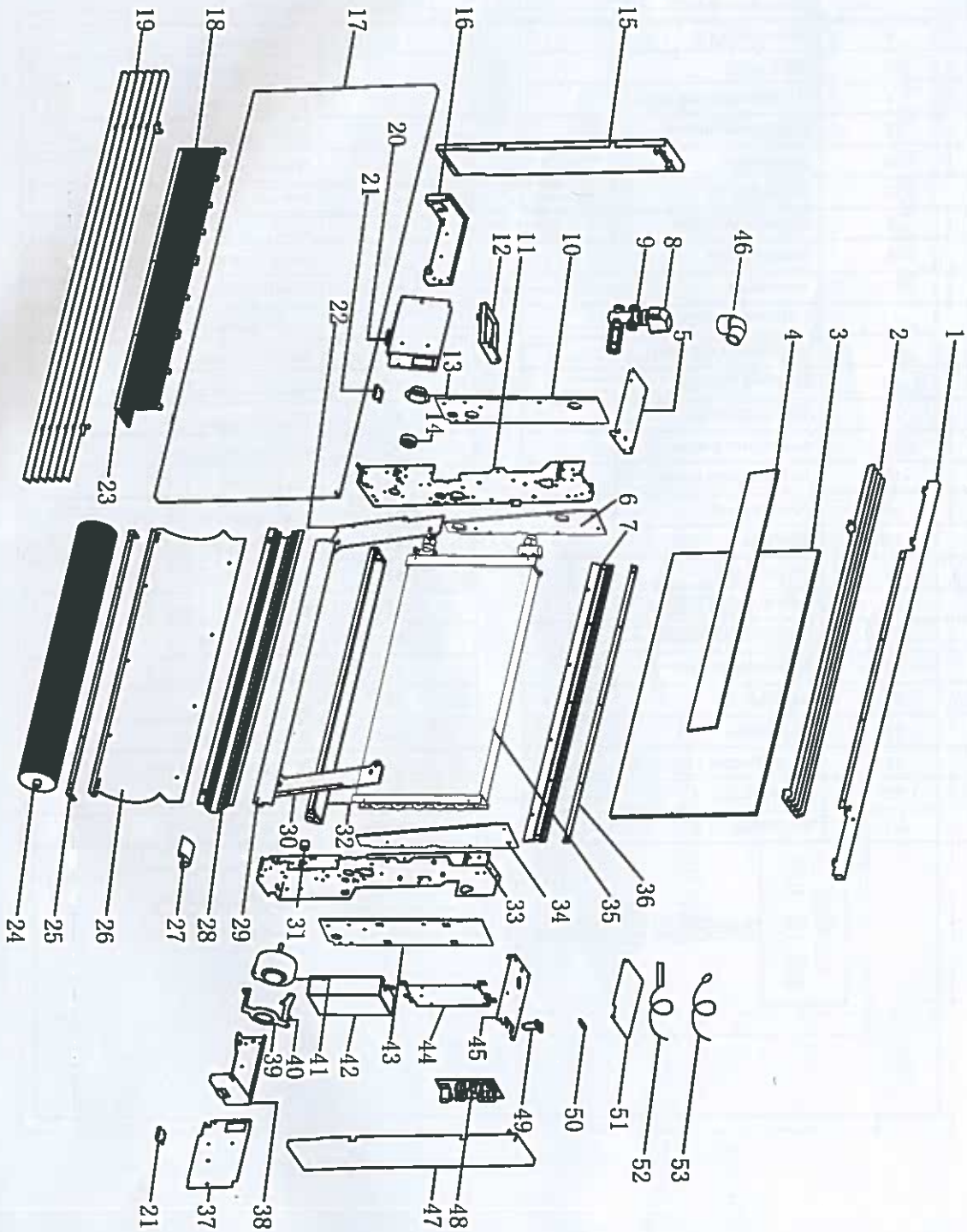

## ► 5. Appendix

SN	Name
1	Connection bar
2	Air outlet grill
3	ABS plate
4	Air deflector sponge
5	Decorative panel
6	Insulation
7	Air deflector 4
8	Valve controller
9	Water valve
10	Insulation
11	Left-inner plate
12	Auxiliary drain pan
13	Bearing fixture 1
14	Bearing fixture 2
15	Left-outer plate
16	Left support plate 1
17	Front panel
18	Air filter 1
19	Air inlet grill
20	Left support plate 2
21	Air inlet grill fixture
22	Coil fixture-left
23	Air filter 2
24	Fan blade
25	Air deflector supporter
26	Air deflector 3
27	Air deflector 5

SN	Name
28	Air deflector 1
29	Air deflector 2
30	Coil fixture-right
31	Rubber plug
32	Drain pan
33	Right-inner plate
34	Insulation
35	Coil
36	Air guide plate 4 support plate
37	Right-support plate 2
38	Right-support plate 1
39	Motor fixture 1
40	Motor fixture 2
41	DC fan motor
42	Electric box cover
43	Insulation
44	Electrical Installation plate
45	Operation panel supporter
46	Rubber elbow
47	Right-outer plate
48	Circuit board
49	Magnetic
50	Magnetic fixture
51	Decorative panel
52	Coil temperature sensor
53	Air inlet/outlet sensor



# 5. Appendix

## 5.2 Wiring diagram

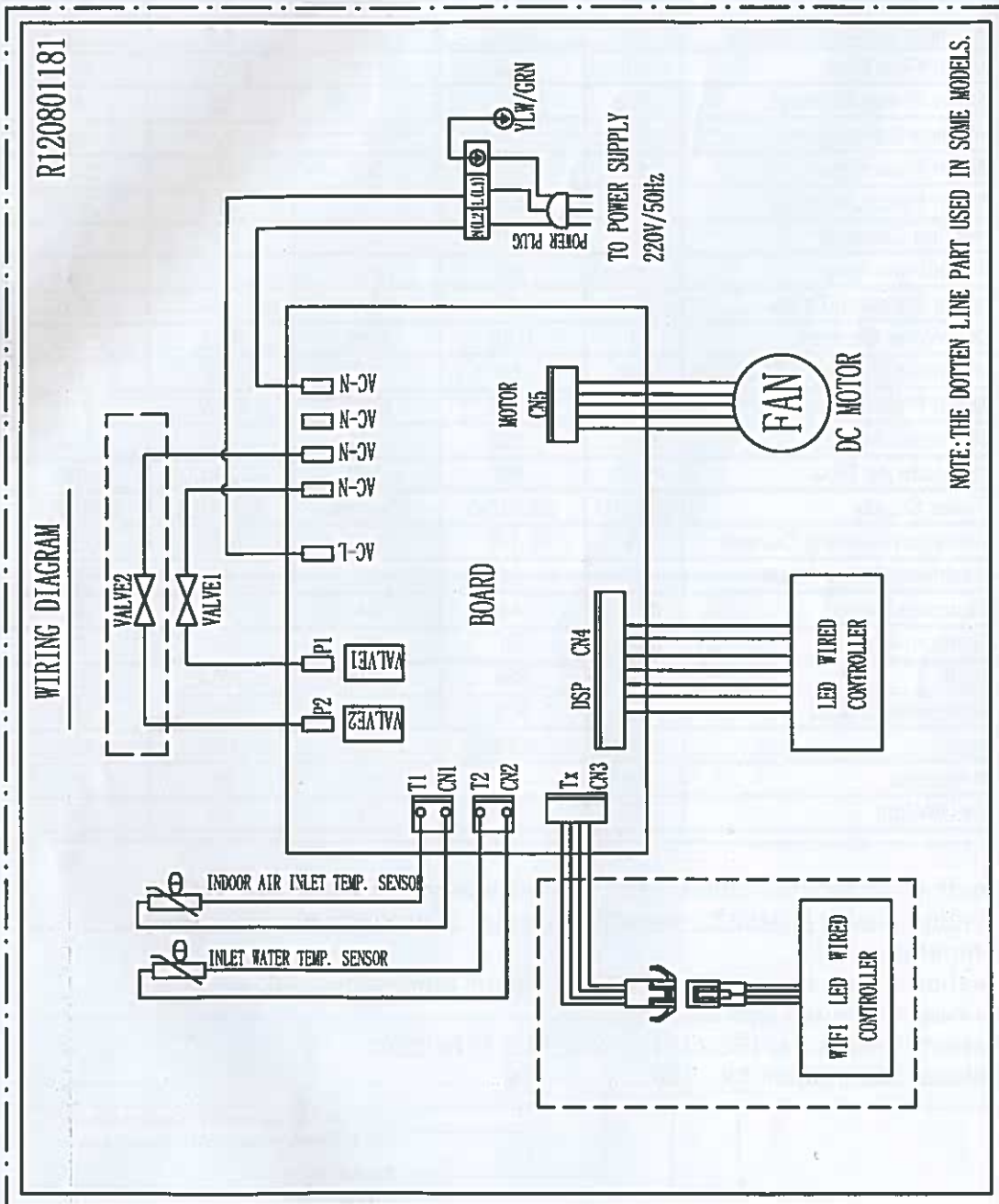

## ► 5. Appendix

### 5.3 Technical Data

Model		MS200DC-V	MS400DC-V	MS600DC-V	MS800DC-V
(a) Total Cooling Capacity	kw	0.75	1.5	2.2	3.1
Sensible Cooling Capacity	kw	0.61	1.25	1.9	2.6
Water Flow Rate	l/h	142	302	453	573
Water Pressure Drops	kPa	7	9	22	28
(b) Heating Capacity	kw	0.99	2	2.8	4.2
Water Flow Rate	l/h	142	302	453	573
Water Pressure Drops	kPa	6.5	7	18.5	24.5
(c) Heating Capacity	kw	1.55	3.1	4.6	6.3
Water Flow Rate	l/h	162	343	471	600
Water Pressure Drops	kPa	7	7.5	19	25.0
Coil Water Content	l	0.48	0.85	1.15	1.48
Maximum Operating Pressure	bar	10	10	10	10
Water Pipe Connector	inches	G1/2	G1/2	G1/2	G1/2
(d) Maximum Air Flow	m <sup>3</sup> /h	160	320	460	580
(d) Minimum Air Flow	m <sup>3</sup> /h	50	150	200	300
Power Supply	V/ph/Hz	230/1/50	230/1/50	230/1/50	230/1/50
Maximum Running Current	A	0.115	0.16	0.21	0.24
Maximum Power Input	W	14	23	27	33
(e) Maximum Noise	dB(A)	44	44	44	44
(e) Minimum Noise	dB(A)	28	28	28	28
Length	mm	694	894	1094	1294
Height(without feet)	mm	580	580	580	580
Depth	mm	129	129	129	129
Net Weight	kg	16	22	28	34
Gross Weight	KG	18	24	30	36

**Note:**

(a) Cooling: Water inlet/outlet 7/12°C; Room temperature DB/WB 27/19°C.

(b) Heating: Water inlet 50°C, water flow rate as in cooling operation; Room temperature 20°C.

(c) Heating: Water inlet 70°C, outlet 60°C; Room temperature 20.

(d) Air flow measured with clean filter.

(e) Noise tested as per ISO23741/2 and ISO 7779:2001

( f ) Model description: **BM 150 C - \*W**

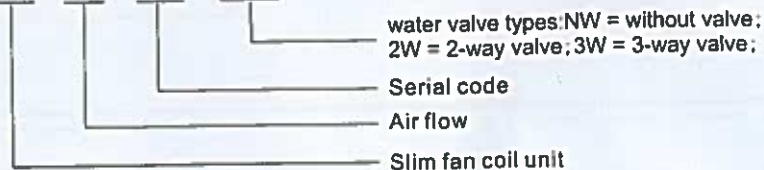

The specification are subject to change without prior notice. For actual specifications of unit, please refer to the stickers on the unit.