

# INVERTER POOL PUMP

INSTALLATION AND OPERATION MANUAL



# CONTENTS

1.  IMPORTANT SAFETY INSTRUCTIONS.....	1
2. TECHNICAL SPECIFICATIONS.....	2
3. OVERALL DIMENSION (mm).....	2
4. INSTALLATION.....	3
5. SETTING AND OPERATION.....	5
6. WIFI OPERATION.....	11
7. EXTERNAL CONTROL.....	18
8. PROTECTION AND FAILURE.....	19
9. MAINTENANCE.....	21
10. WARRANTY & EXCLUSIONS.....	22
11. DISPOSAL.....	22

THANK YOU FOR PURCHASING OUR INVERTER POOL PUMPS.

THIS MANUAL CONTAINS IMPORTANT INFORMATION THAT WILL HELP YOU IN OPERATING AND MAINTAINING THIS PRODUCT.

PLEASE READ THE MANUAL CAREFULLY BEFORE INSTALLATION & OPERATION AND RETAIN IT FOR FUTURE REFERENCE.



## 1. IMPORTANT SAFETY INSTRUCTIONS

This guide provides installation and operation instructions for this pump. If you have any other questions about this equipment, please consult your supplier.

### 1.1 When installing and using this electrical equipment, basic safety precautions should always be followed, including the following:

- RISK OF ELECTRICAL SHOCK. Connect only to a branch circuit protected by a ground-fault circuit-interrupter (GFCI). Contact a professionally trained and qualified electrician if you cannot verify that the circuit is protected by a GFCI.
- TO PREVENT THE RISK OF ELECTRICAL SHOCK, please connect the ground wire on the motor (green/yellow) to the grounding system.
- This pump is for use with permanently installed in-ground or above-ground swimming pools and may also be used with hot tubs and spas with a water temperature under 50°C. Due to the fixed installation method, this pump is not suggested to be used on above-ground pools that can be readily disassembled for storage.
- The pump is not submersible.
- Never open the inside of the drive motor enclosure.

### 1.2 All installations must be fitted with earth leakage or residual current protection devices, having a rated residual operating current not exceeding 30mA.

#### WARNING:

- Fill the pump with water before starting. Do not run the pump dry. In case of dry run, mechanical seal will be damaged and the pump will start leaking.
- Before servicing the pump, switch OFF power to the pump by disconnecting the main circuit to the pump and release all pressure from pump and piping system.
- Never tighten or loosen screws while the pump is operating.
- Ensure that the inlet and outlet of the pump are unblocked with foreign matter.

## 2. TECHNICAL SPECIFICATIONS

Model	Advised Pool Volume (m <sup>3</sup> )	P1	Voltage (V/Hz)	Qmax (m <sup>3</sup> /h)	Hmax (m)	Circulation (m <sup>3</sup> /h)	
		KW				At 8m	At 10m
IW20	30-50	0.75	220-240/ 50/60	23.7	11.3	17.4	11.6
IW25	40-70	1.05		26.3	13.9	23.1	19.5
IW30	60-90	1.4		28.7	16.7	27.5	25.1

## 3. OVERALL DIMENSION (mm)

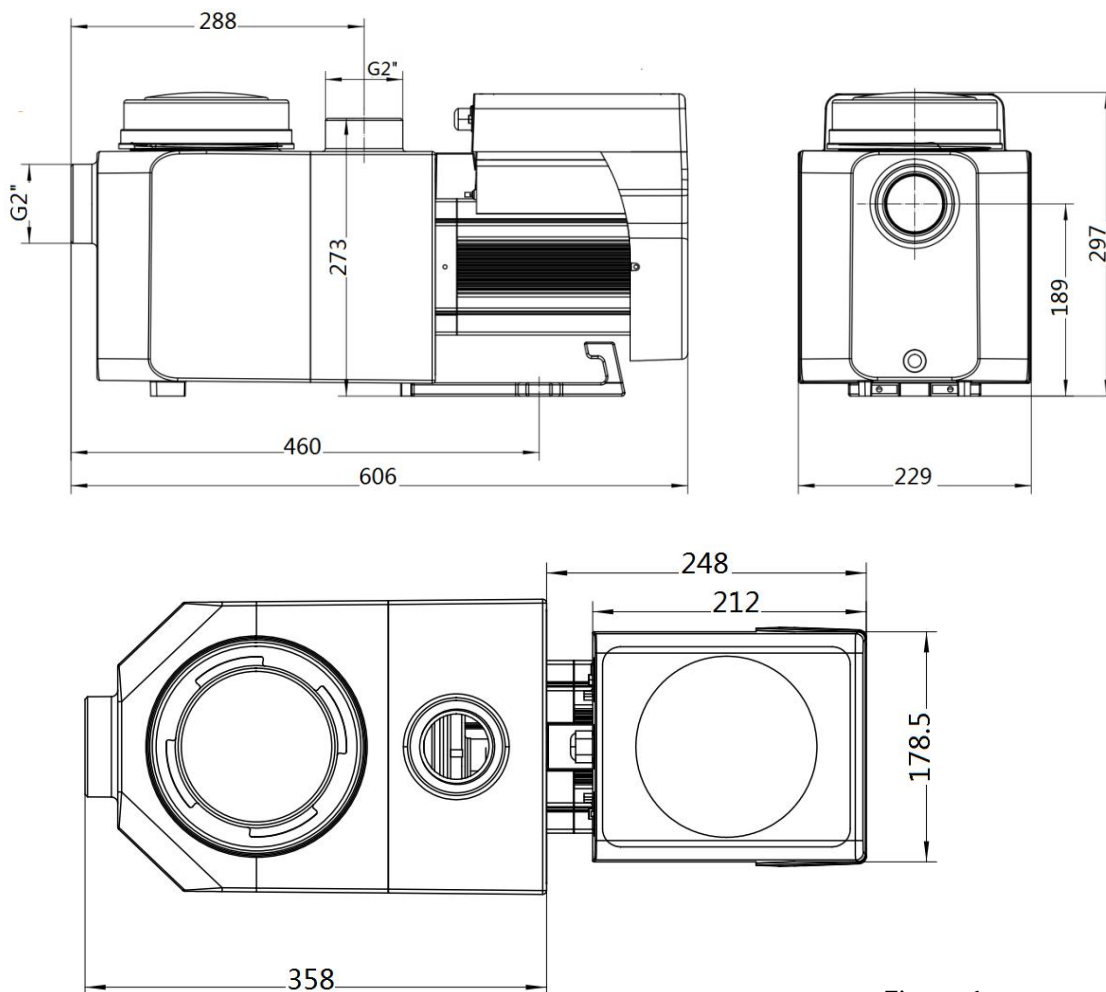

Figure 1

## **4. INSTALLATION**

### **4.1. Pump Location**

- 1) Install the pump as close to the pool as possible, to reduce friction loss and improve efficiency, use short, direct suction and return piping.
- 2) To avoid direct sunshine, heat or rain, it is recommended to place the pump indoors or in the shade.
- 3) DO NOT install the pump in a damp or non-ventilated location. Keep pump and motor at least 150mm away from obstacles, pump motors require free circulation of air for cooling.
- 4) The pump should be installed horizontally and fixed in the hole on the support with screws to prevent unnecessary noise and vibration.

### **4.2. Piping**

- 1) For optimization of the pool plumbing, it is recommended to use a pipe with size of 63mm. When installing the inlet and outlet fittings (joints), use the special sealant for PVC material.
- 2) The dimension of suction line should be the same or larger than the inlet line diameter, to avoid pump sucking air, which will affect the efficiency of the pump.
- 3) Plumbing on the suction side of the pump should be as short as possible.
- 4) For most installations we recommend installing a valve on both the pump suction and return lines, which is more convenient for routine maintenance. However, we also recommend that a valve, elbow, or tee installed on the suction line should be no closer to the front of the pump than seven times the suction line diameter.
- 5) Pump outlet piping system should be equipped with a check valve to prevent the pump from the impact of medium recirculation and pump-stopping water hammer.

### **4.3. Valves and Fittings**

- 1) Elbows should be no closer than 350mm to the inlet. Do not install 90° elbows directly into the pump inlet/outlet. Joints must be tight.

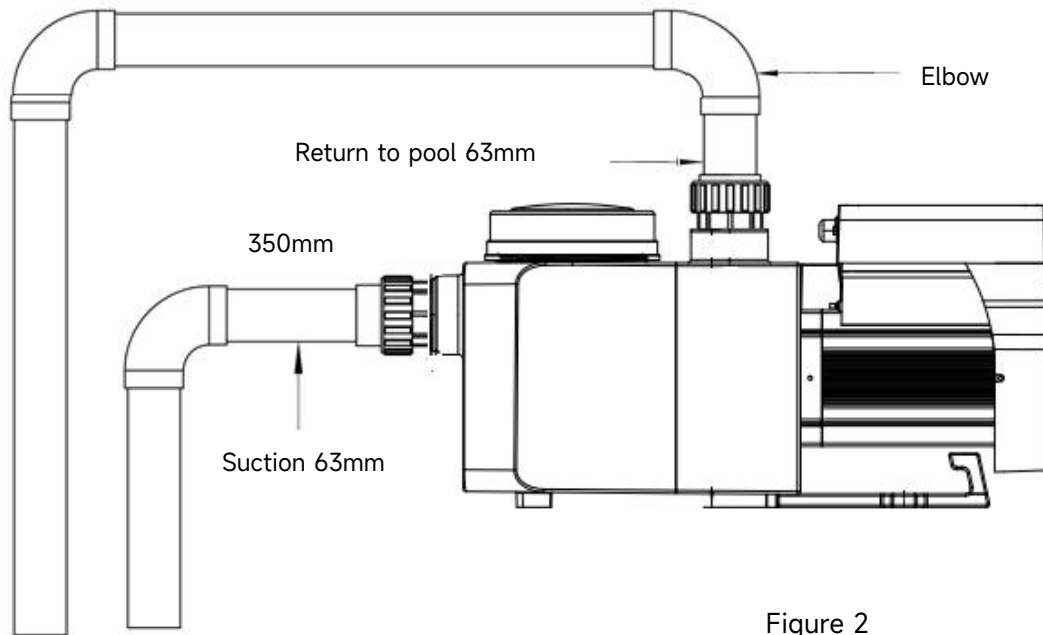

Figure 2

\* The pump inlet/outlet union size: optional with metric (50 or 63mm) or imperial (1.5" or 2")

2) Flooded suction systems should have gate valves installed on suction and return line for maintenance; however, the suction gate valve should be no closer than seven times the suction pipe diameter as described in this section.

3) Use a check valve in the return line where there is significant height between the return line and the outlet of the pump.

4) Be sure to install check valves when plumbing in parallel with other pumps. This helps prevent reverse rotation of the impeller and motor.

#### **4.4 Check before initial startup**

- 1) Check whether pump shaft rotates freely;
- 2) Check whether power supply voltage and frequency conform to the nameplate;
- 3) Facing the fan blade, the direction of motor rotation should be clockwise;
- 4) It is forbidden to run the pump without water.

## 4.5 Application conditions

Ambient temperature	Indoor installation, temperature range: -10~42°C
Water temperature	5°C~50°C
Salt pools	Salt concentration up to 0.5%, i.e 5g/l
Humidity	≤90% RH, (20°C±2°C)
Altitude	Not exceed 1000m above sea level
Installation	The pump can be installed max. 2m above water level
Insulation	Class F, IP55

## 5. SETTING AND OPERATION

### 5.1 Display on control panel:

	① Power consumption
	② Running capacity / Flow rate
	③ WIFI indicator
	④ Unit of flow
	⑤ Timer period
	⑥ Timer 1/2/3/4
	Backwash/unlock
	Up/down: to change the value (capacity/flow/time)
	Switch between Manual-Inverter Mode and Auto-Inverter Mode <b>Manual-Inverter Mode:</b> The running capacity will be set manually between 30%-100% <b>Auto-Inverter Mode:</b> The running capacity will be automatically adjusted between 30%-100% according to the preset flow rate. The default mode is <b>Manual-Inverter</b> mode.
	Timer setting
On/off	

## 5.2 Startup:

When the power is switched on, the screen will be fully light for 3 seconds, the device code will be displayed, and then it will enter the normal working state. When the screen is locked, only the button



will light up; Press and hold



for more than 3 seconds, other buttons will all light up. The screen will automatically lock up when there is no operation for more than 1 minute and the

brightness of the screen is reduced by 1/3 of the normal display. Short press  to wake up the screen and observe the relevant operating parameters.

## 5.3 Self-priming

When switched on for the first time after installation, the pump will start self-priming automatically and followed by self-learning.

- **Self-priming:**

When the system performs self-priming, it will count down from 1500s and stop automatically when the system detects the pump is full of water, then the system will recheck for 30s again to make sure the self-priming is completed.

User can exit self-priming manually by pressing  for more than 3 seconds. The pump will start self-learning process for 180s and then enter the default Manual-Inverter mode if the user exits the first self-priming manually. If the user exits the self-priming after the following start up, the pump will run as per the mode and setting before the last shut-down.

- **Self-learning:**

After the first self-priming is completed, the system will perform the first time self-learning for 180s, and redefine the adjustable flow range of the pump by detecting the pipeline pressure.

eg: the default adjustable flow range of InverWarrior IW24 is 5-25 m<sup>3</sup>/h, after self-learning, the range may be redefined to 7-22 m<sup>3</sup>/h. User can still set 25 m<sup>3</sup>/h in this situation, the pump will adjust the running capacity automatically to reach the current reachable max. flow rate (22 m<sup>3</sup>/h), and the flow display on the controller will turn back to 22 m<sup>3</sup>/h after 3 seconds



The default adjustable flow range for InverWarrior is as below:

Model	Default adjustable flow rate range
IW20	5~20 m <sup>3</sup> /h
IW25	5~25 m <sup>3</sup> /h
IW30	5~30 m <sup>3</sup> /h

### Remark:

The pump is delivered with self-priming enabled. Each time the pump restarts, it will perform self-priming automatically. The user can enter the parameter setting to disable the default self-priming function (see 5.8)





If the default self-priming function is disabled, and the pump has not been used for a long time, the water level in basket may drop, user can manually activate the self-priming function by pressing both   for 3 seconds, the adjustable period is from 600s to 1500s (default value is 600s). After the manual self-priming is completed, the pump will perform self-learning for 180s to redefine the flow range of the system.

User can press  for more than 3 seconds to exit the manual self-priming, the pump will perform self-learning for 180s after the next restart.











#### 5.4 Backwash

User can start the backwash or fast re-circulation in any running state by pressing .

	Default	Setting range
Time	180s	Press  or  to adjust from 0 to 1500s with 30 seconds for each step
Running capacity	100%	80~100%, enter the parameter setting (see 5.8)













If backwash is completed or disabled, press and hold  for 3 seconds, the pump will return to the normal operating state before backwash.

#### 5.5 Manual-Inverter Mode

1		Hold  for more than 3 seconds to unlock the screen;
2		Press  to start. The pump will run at 80% of the running capacity after self-priming.
3	 	Press  or  to set the running capacity between 30%~100%, each step by 5%
4		Press  again to switch to Auto-Inverter mode.

#### 5.6 Auto-Inverter Mode

Under Auto Inverter Mode, the pump could automatically detect the system pressure and adjust the speed of motor to reach the set flow.

1		Unlock the screen, press  to shift from the Manual-Inverter mode to Auto-Inverter mode.
2	 	The flow rate could be adjusted, by pressing  or  with 1m <sup>3</sup> /h for each step.
3	 	The unit of flow rate could be changed to lpm, IMP gpm or US GPM, by pressing both   for 3 seconds (default is m <sup>3</sup> /h)
4		Press  to switch to Manual-Inverter mode

**Note:**









After the first self-priming, the pump will redefine the adjustable flow range. The pipeline pressure will be recorded by the system after the pump running at the set flow/capacity for 3 minutes without other operation.



During the pump running, if it is detected that the pipeline pressure changes beyond a certain range, the icon of % or m<sup>3</sup>/h (or other flow unit) symbol will flash for 5 minutes. If the change last for 5 minutes, the pump will perform a self-priming and self-learning procedure (see 5.3), and redefine the flow range accordingly.

After the redefinition of flow range, the pump will automatically adjust the running capacity to reach the set flow.

**5.7 Timer mode**

The pump's on/off and running capacity could be commanded by timer, which could be programmed daily as needed.

1	Enter timer setting by pressing 
2	Press  or  to set the local time
3	Press  to confirm and move to time-1 setting
4	Press  or  to choose the desired running periods, running capacity or flow rate (when % icon is flashing, user can change to set the flow rate by pressing 
5	 Repeat above steps to set other 3 timers

6	 Hold 3 seconds to save setting
7	 or  Check 4 timers to make sure there is no invalid setting

**Note:**

When timer mode is activated, if the set time period contains the current time, the pump will start running according to the set running capacity or flow rate. If the set time period does not contain the current time, the timer number 

1	2	3	4
---	---	---	---

 (or 1 or 2 or 3 or 4) that is about to start running will be displayed on the controller and flash, **88:88 - 88:88** will display the corresponding time period, indicating a successful timer setting.



All 4 time periods should be set in chronological order. Overlap setting of time will be considered as invalid, the pump will only run based on the previous valid setting. If all 4 time periods set by the timer are invalid, 

-	-	:	-	-	-	:	-	-
---	---	---	---	---	---	---	---	---











 and 

1	2	3	4
---	---	---	---

 will flash to remind the user, you can press  to reset the time period again to make sure they are valid.

During timer setting, if you want to return to the previous setting, hold both   for 3 seconds. If you don't need to set all 4 timers, you can hold  for 3 seconds, the system will automatically save the current set value and activate the timer mode.

**5.8 Parameter Setting**

Restore factory setting	Under off mode, hold both   for 3 seconds
Check the software version	Under off mode, hold both   for 3 seconds
Manual priming	Under on mode, hold both   for 3 seconds
Enter parameter setting as below	Under off mode, hold both   for 3 seconds; If current address does no need to be adjusted, hold both   to next address

<b>Parameter Address</b>	<b>Description</b>	<b>Default Setting</b>	<b>Setting Range</b>
1	PIN3	100%	30~100%, by 5% increments
2	PIN2	80%	30~100%, by 5% increments
3	PIN1	40%	30~100%, by 5% increments
4	Backwash capacity	100%	80~100%, by 5% increments
5	Control mode of Analog Input	0	0: current control 1: Voltage control
6	Enable or disable the priming that occurs at each start	25	25:enables 0: disables

## 6. WIFI OPERATION

### 1 InverFlow Download



Android



iOS



### 2 Account registration

Register by e-mail or third-party application

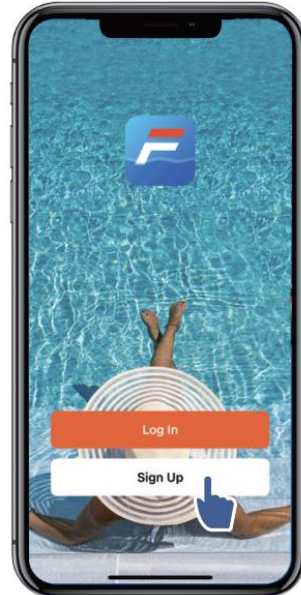

#### a. Email Registration

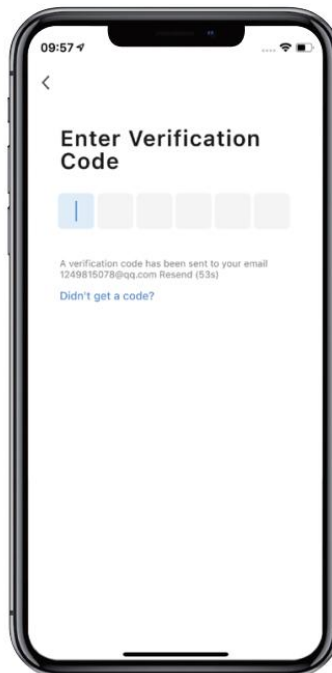
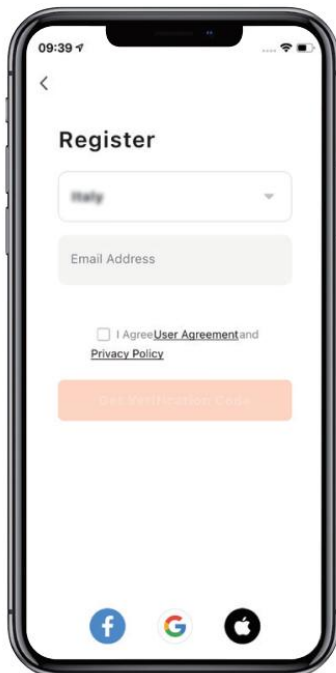

## b. Third-party application registration

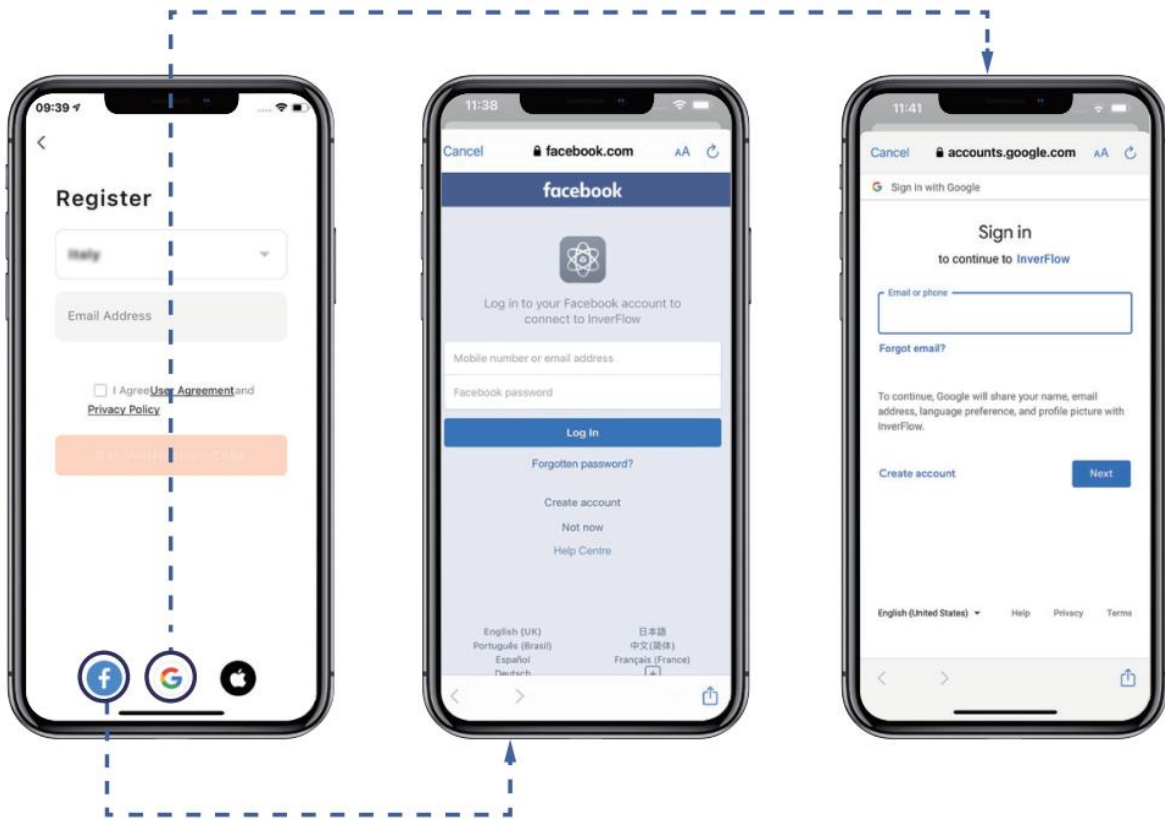

## 3 Create Home

Please set home name and choose the location of the device. (It is recommended to set the location so the weather can be shown in the App for your convenience)

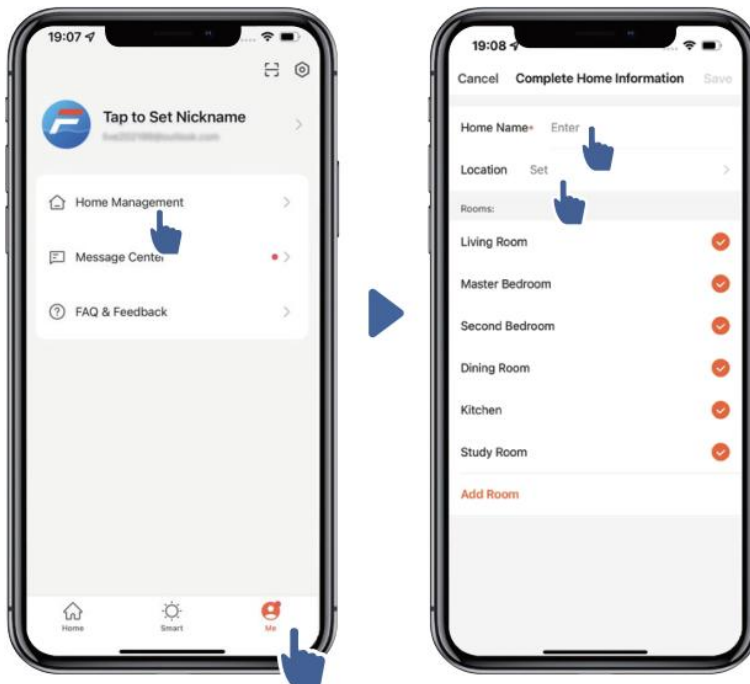

## 4 App pairing

Please make sure your pump is turned on before you start.

### Option 1 (Recommended): With Wifi and Bluetooth

(Network requirement: 2.4GHz; 2.4GHz and 5GHz into one SSID; but no separate 5GHz network)

1) Please confirm that your phone is connected to Wifi and your Bluetooth is on.



2) Press  for 3 seconds until hearing "Beep" to unlock the screen. Press  for 5

seconds until hearing "Beep" then release.  Will flash

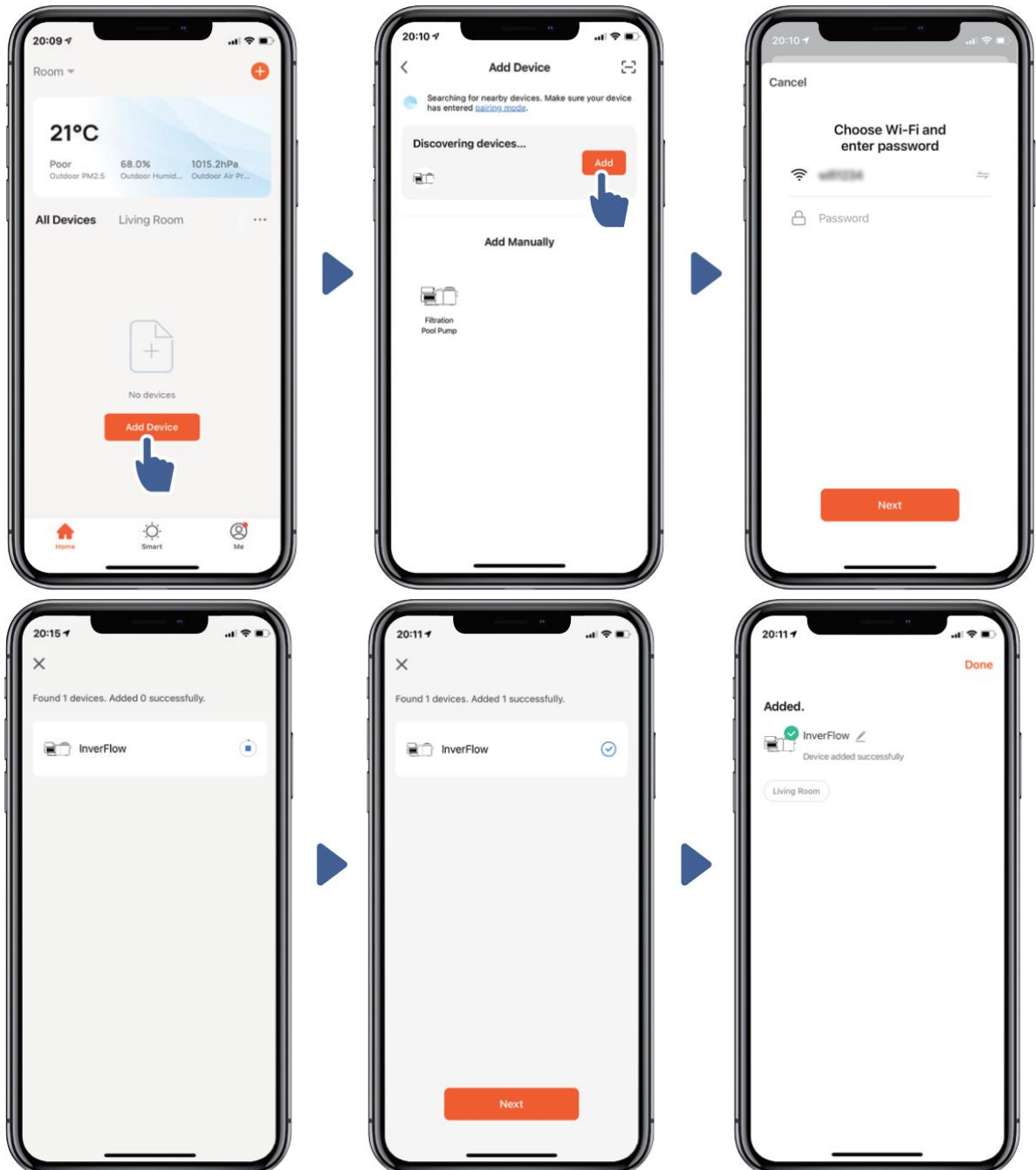
3) Click "Add Device", and then follow the instructions to pair device.



## Option 2: With Wifi (Network requirement: 2.4GHz only)

- 1) Please confirm that your phone is connected to Wifi
- 2) Press  for 3 seconds until hearing “Beep” to unlock the screen. Press  for 5 seconds until hearing “Beep” then release.  Will flash.
- 3) Click “Add Device”, and then follow the instructions to pair device.

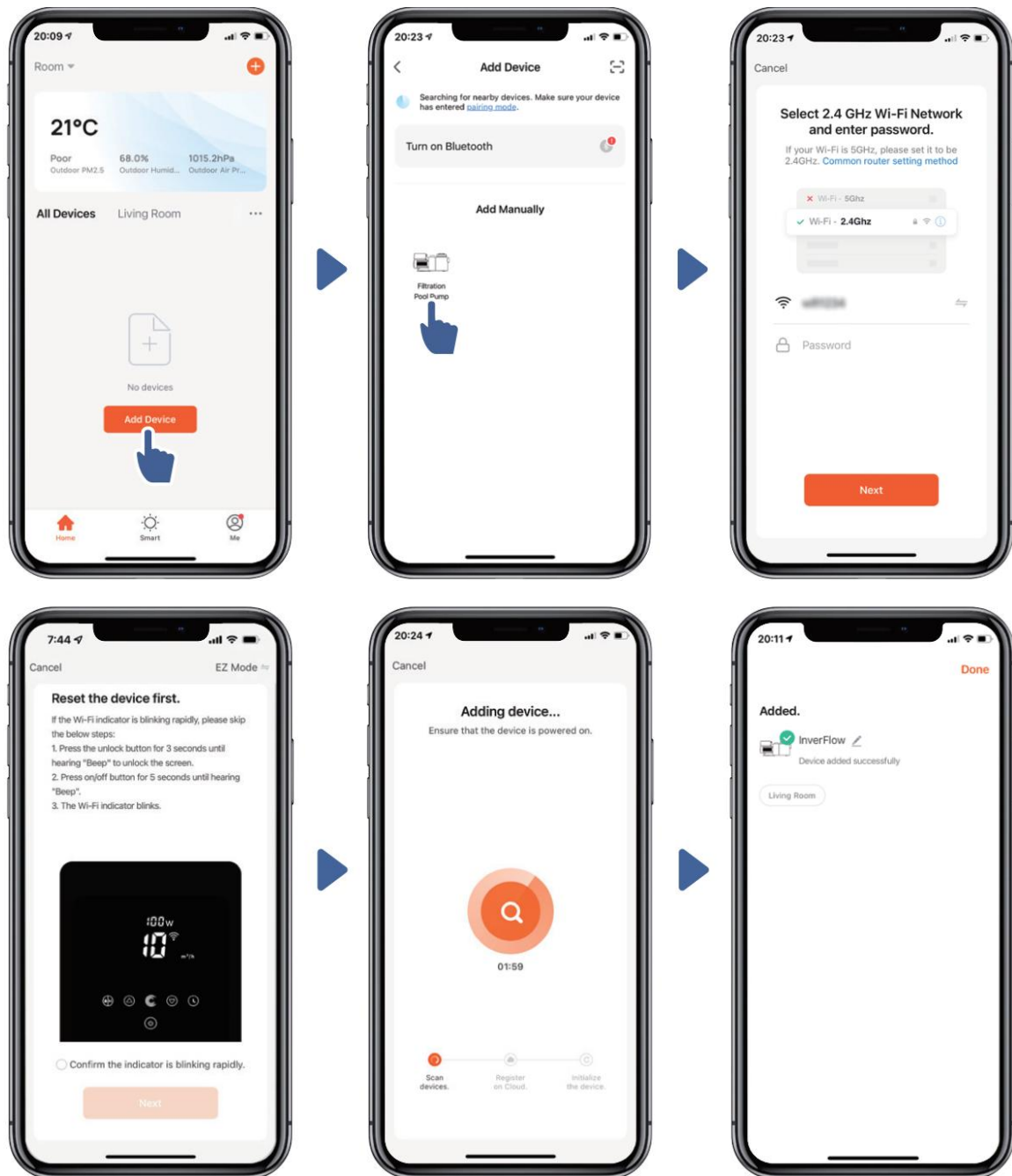



## 5 Operation

1) Using Auto Inverter mode:

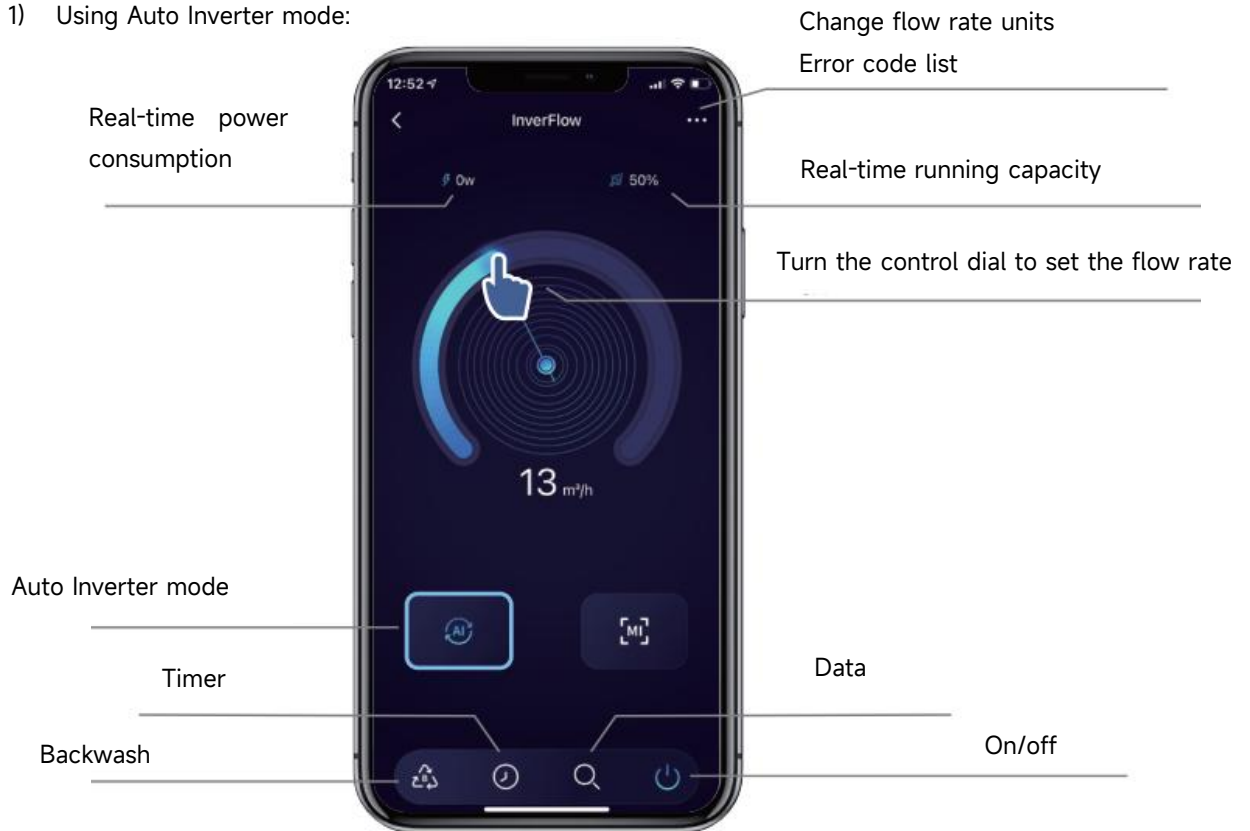

2) Using Manual Inverter mode:



## 6 Sharing Devices with your family members

After pairing, if your family members also want to control the device, please let your family members register “InverFlow” first, and then the administrator can operate as below:

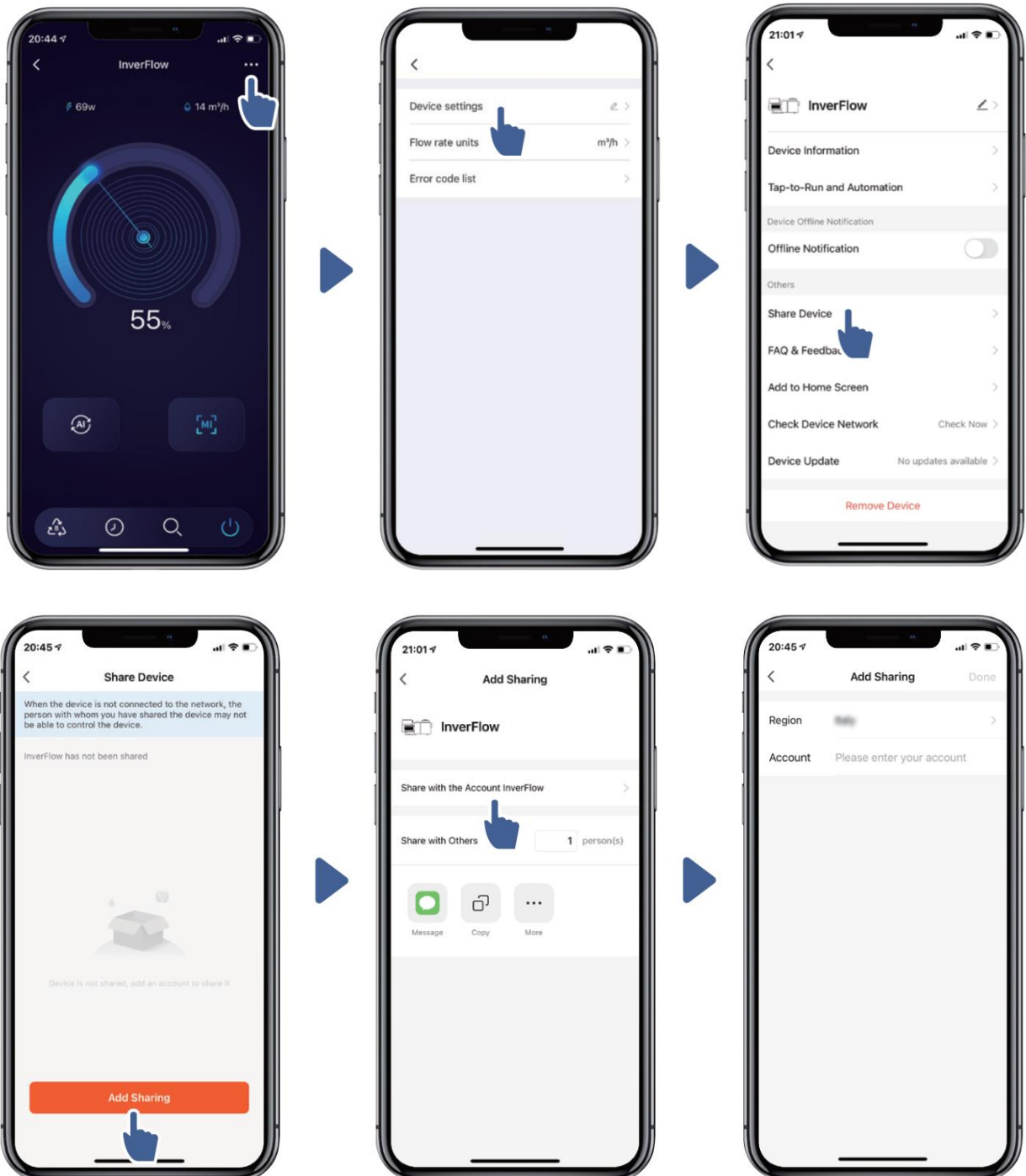

## 7 Feedback

If you have any problem while using, welcome to send feedback.

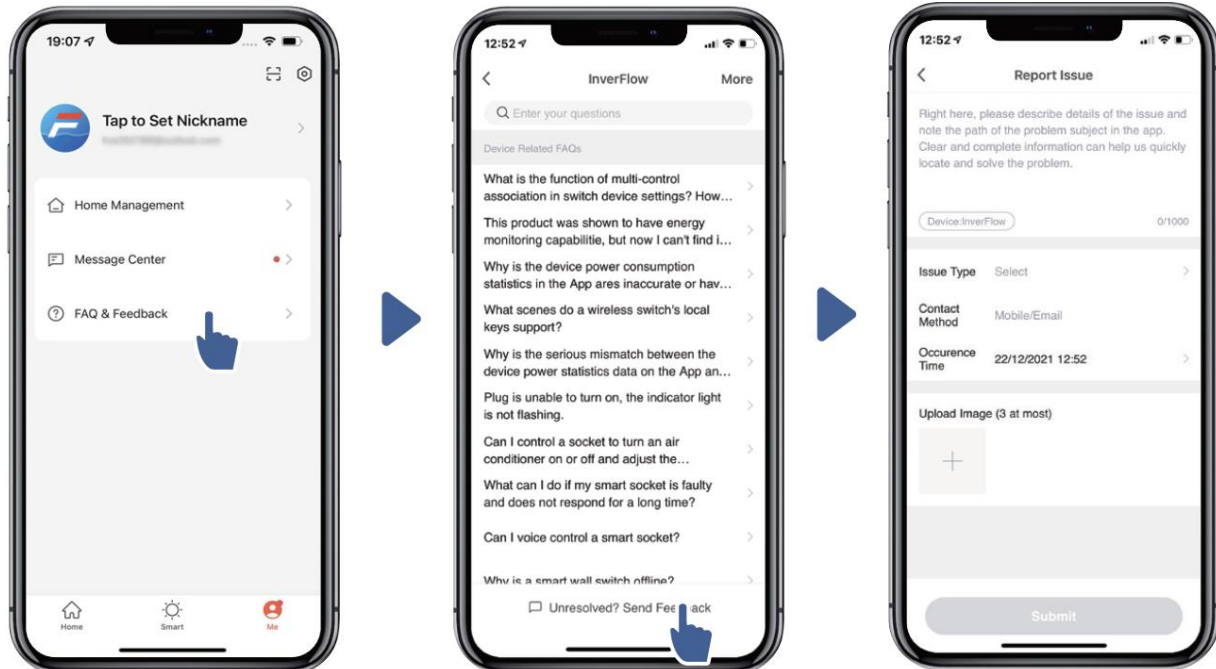

Notice:

- 1) Weather forecast is just for reference;
- 2) The power consumption data is for reference only, as it may be affected by network problems and imprecision of the calculation.
- 3) App is subject to updates without notice.

## 7. EXTERNAL CONTROL

External control can be enabled via following contacts. If more than one external control is enabled, the priority is as below: Digital Input > RS485 > Panel control

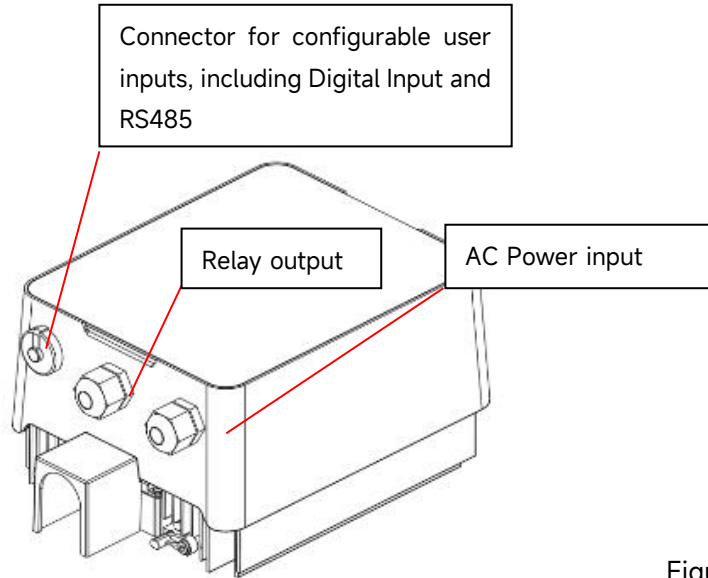

Figure 3

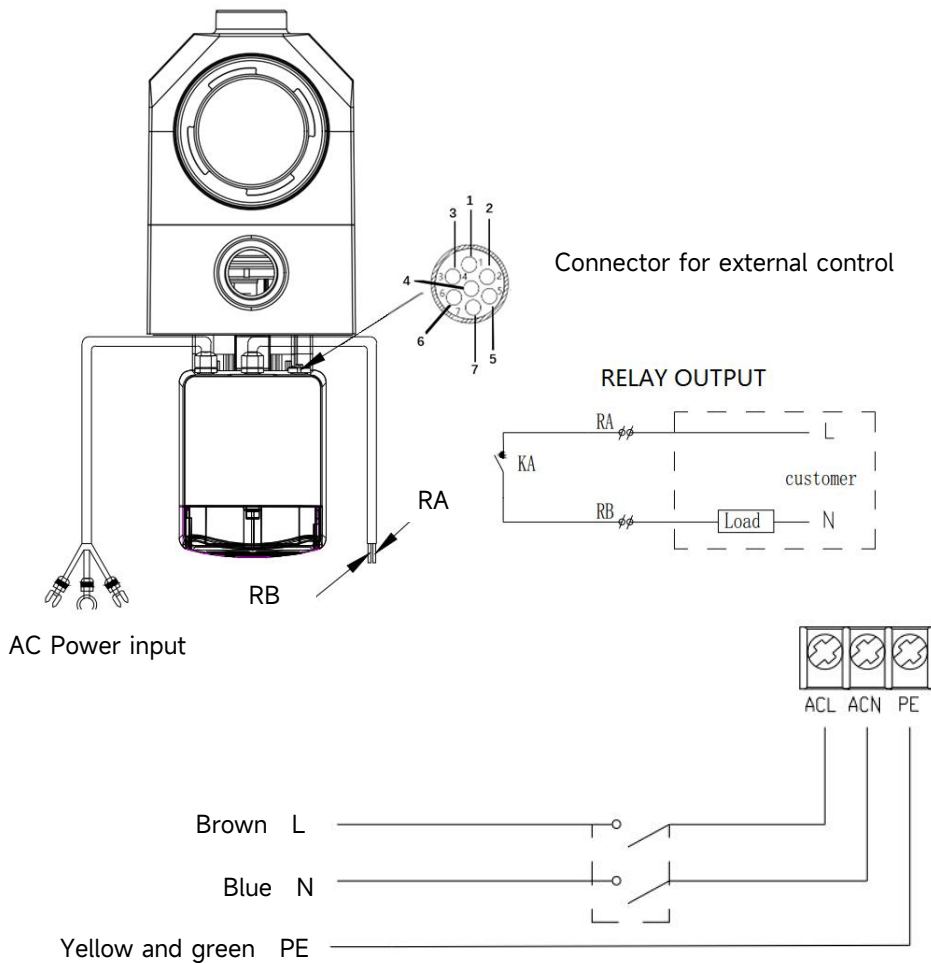

Figure 4

Name	Color	Description
PIN 1	Red	Digital Input 4
PIN 2	Black	Digital Input 3
PIN 3	White	Digital Input 2
PIN 4	Grey	Digital Input 1
PIN 5	Yellow	Digital Ground
PIN 6	Green	RS485 A
PIN 7	Brown	RS485 B

#### **a. Digital input:**

Running capacity is determined by the state of digital input,

When PIN4 connect with PIN5, the pump will be mandatory to stop; if disconnected, the digital controller will be invalid;

When PIN3 connect with PIN5, the pump will be mandatory to run at 100%; if disconnected, the control priority will be back on panel control;

When PIN2 connect with PIN5, the pump will be mandatory to run at 80%; if disconnected, the control priority will be back on panel control;

When PIN1 connect with PIN5, the pump will be mandatory to run at 40%; if disconnected, the control priority will be back on panel control;

The capacity of inputs (PIN1/PIN2/PIN3) could be modified according to the parameter setting.

#### **b. RS485:**

To connect with PIN6 and PIN7, the pump could be controlled via Modbus 485 communication protocol.

#### **c. Relay output (optional):**

Connect terminal L & N to enable external control. An additional on-off Relay is necessary while bearing power is greater than 500W (2.5A).

## **8. PROTECTION AND FAILURE**

### **8.1 High Temperature Warning and Speed Reduction**

In “Auto-Inverter/Manual-Inverter Mode” and “Timer mode” (except backwash/self-priming), when the module temperature reaches the high temperature warning trigger threshold (81°C), it enters the high temperature warning state; when the temperature drops to the high temperature warning release threshold (78°C), the high temperature warning state is released. The display area alternately displays AL01 and running speed or flow

1) If AL01 displayed for the first time, the running capacity will be automatically reduced as below:

a) If current operating capacity is higher than 85%, the running capacity will be automatically reduced by 15%;

- b) If current operating capacity is higher than 70%, the running capacity will be automatically reduced by 10%;
- c) If current operating capacity is lower than 70%, the running capacity will be automatically reduced by 5%.

2) Suggestion for non-first displayed of AL01: check the module temperature every 2 minutes. Compared with the temperature in the previous period, for every 1-degree Celsius increase, the speed will decrease by 5%.

## 8.2 Undervoltage protection

When the device detects that the input voltage is less than 197V, the device will limit the current running speed

When input voltage is less than or equal to 180V, the running capacity will be limited to 70%;

When the input voltage range is within 180V ~ 190V, the running capacity will be limited to 75%;

When the input voltage range is within 190V ~ 197V, the running capacity will be limited to 85%.

## 8.3 Trouble shooting

<b>Problem</b>	<b>Possible causes and solution</b>
<b>Pump does not start</b>	<ul style="list-style-type: none"> <li>• Power Supply fault, disconnected or defective wiring.</li> <li>• Fuses blown or thermal overload open.</li> <li>• Check the rotation of the motor shaft for free movement and lack of obstruction.</li> <li>• Because of long time lying idle. Unplug the power supply and manually rotate motor rear shaft a few times with a screwdriver.</li> </ul>
<b>Pump does not prime</b>	<ul style="list-style-type: none"> <li>• Empty pump/strainer housing. Make sure the pump/strainer housing is filled with water and the O ring of cover is clean.</li> <li>• Loose connections on the suction side.</li> <li>• Strainer basket or skimmer basket loaded with debris.</li> <li>• Suction side clogged.</li> <li>• Distance between pump inlet and liquid level is higher than 2m, height of pump installation should be lowered.</li> </ul>
<b>Low Water Flow</b>	<ul style="list-style-type: none"> <li>• Pump does not prime.</li> <li>• Air entering suction piping.</li> <li>• Basket full of debris.</li> <li>• Inadequate water level in pool.</li> </ul>
<b>Pump being noisy</b>	<ul style="list-style-type: none"> <li>• Air leak in suction piping, cavitation caused by restricted or undersized suction line or leak at any joint, low water level in pool, and unrestricted discharge return lines.</li> <li>• Vibration caused by improper installation, etc.</li> <li>• Damaged motor bearing or impeller (need to contact the supplier for repair).</li> </ul>

## 8.4 Error code

When the device detects a failure (except for the running capacity reduction strategy and 485 communication failure), it will power off automatically and display the failure code. After power off for 15 seconds, check if the failure is cleared, if cleared, it will resume to start.

Item	Error Code	Description
1	E001	Abnormal input voltage
2	E002	Output over current
3	E101	Heat sink over heat
4	E102	Heat sink sensor error
5	E103	Master driver board error
6	E104	Phase-deficient protection
7	E105	AC current sampling circuit failure
8	E106	DC abnormal voltage
9	E107	PFC protection
10	E108	Motor power overload
11	E201	Circuit board error
12	E203	RTC time reading error
13	E204	Display Board EEPROM reading failure
14	E205	Communication Error
15	E207	No water Protection
16	E208	Pressure sensor failure
17	E209	Loss of prime

Note:

1. When causes for E002/E101/E103 is displayed, the device will resume working automatically, however when it appears a fourth time, the device will stop working, to resume operation, unplug the device and plug in & restart again.

## 9. MAINTENANCE

Empty the strainer basket frequently. The basket should be inspected through the transparent lid and emptied when there is an evident stack of rubbish inside. The following instructions should be followed:

- 1). Disconnected the power supply.
- 2). Unscrew the strainer basket lid anti-clockwise and remove.
- 3). Lift up the strainer basket.
- 4). Empty the trapped refuse from the basket, rinse out the debris if necessary.

**Note: Do not knock the plastic basket on a hard surface as it will cause damage**

- 5). Inspect the basket for signs of damage, replace it.
- 6). Check the lid O-ring for stretching, tears, cracks or any other damage
- 7). Replace the lid, hand tightening is sufficient.

**Note: Periodically inspect and clean the strainer basket will help prolong its life.**

## 10. WARRANTY & EXCLUSIONS

Should a defect become evident during the term of warranty, at its option, the manufacturer will repair or replace such item or part at its own cost and expense. Customers need to follow the warranty claim procedure in order to obtain the benefit on this warranty.

The guarantee will be void in cases of improper installation, improper operation, inappropriate use, tampering or using non-original spare parts.

## 11. DISPOSAL



When disposing the product, please sort the waste products as electrical or electronic product waste or hand it over to the local waste collection system.

The separate collection and recycling of waste equipment at the time of disposal will help ensure that it is recycled in a manner that protects human health and the

environment. Contact your local authority for information on where you can drop off your water pump for recycling