

DC Inverter Heat Pump

(Monobloc Type)

Instruction Manual

For models: GT-SKR020KBDC-M32
GT-SKR030KBDC-M32
GT-SKR040KBDC-M32
GT-SKR050KBDC-M32

- ◆ Please read the manual carefully before installation and maintenance.
- ◆ Please keep this manual well for future reference.

CONTENTS

Part I: Important safety instruction	1
1.1 Warnings	1
1.2 Important safety instruction	1
Part II Installation	3
2.1 Transportation	3
2.2 Installation site requirement.....	3
2.3 Minimum distance to wall	3
2.4 Installation guide.....	4
2.5 Recommended hydraulic connection.....	5
2.6 Electrical connection.....	6
2.7 Trial operation.....	7
Part III Control System	8
3.1 Controller position	8
3.2 Controller introduction.....	8
3.3 Operation introduction	9
Part IV Maintenance	18
Part V Trouble Shooting	19
Part VI Wiring Diagram.....	23
Disposal.....	26

Part I: Important safety instruction

1.1 Warnings

Read the manual carefully before using the product.







Warnings on the refrigerant















The refrigerant used is R32 fluoride. R32 refrigerant is flammable and odorless. In addition, it can cause explosion in particular conditions. However, its flammability is very low. In order to start the flame, a free flame is required.

R32 refrigerant is a less polluting refrigerant than other gases used in refrigeration circuits and causes much less damage to the ozone layer. The influence on the greenhouse effect is also much lower.

The R32 refrigerant has excellent thermodynamic characteristics, which allows a really high energy efficiency. For the same heating capacity, the system therefore needs a lower charge.

1.2 Important safety instruction

-  1. The unit can be used by children aged from 8 years and above and persons with reduced physical, sensory or mental capabilities or lack of experience and knowledge if they have been given supervision or instruction concerning use of the unit in a safe way and understand the hazards involved. Children shall not play with the unit. Cleaning and user maintenance shall not be made by children without supervision.
-  2. The unit must be installed and repaired by qualified technician.
-  3. The unit shall be installed in accordance with national wiring regulations.
-  4. If the supply cord is damaged, it must be replaced by the manufacturer, its service agent or similarly qualified persons in order to avoid a hazard.

-  5. Before maintenance, please shut off the power to the unit first.
-  6. Do not operate the unit in a wet room such as a bathroom or laundry room.
-  7. Before obtaining access to terminals, all supply circuits must be disconnected.
-  8. An all-pole disconnection device which has at least 3mm clearances in all poles, and have a leakage current that may exceed 10mA, the residual current device (RCD) having a rated residual operating current not exceeding 30mA, and disconnection must be incorporated in the fixed wiring in accordance with the wiring rules.
-  9. A leakage protection switch must be installed near the unit.
-  10. Do not use any damaged cables and switches to avoid any leakage.
-  11. Do not open the electrical box of the unit without shutting off power supply.
-  12. The unit is designed for outdoor installation. Do not install it in a closed space without good ventilation.
-  13. Do not install the unit near inflammable or explosive goods.
-  14. Do not block the air intake or outlet of the unit.
-  15. When the unit is in off status for more than 5 hours with the ambient temperature lower than 2°C, please drain the unit to prevent the formulation of ice in it.
-  16. Keep safety distance between the unit and other equipment or structures according to local norm, and ensure that adequate space for maintenance or service operations.
-  17. Power supply: the diameter of electrical cables must be suitable for the unit and the power supply voltage must correspond with the value indicated on the units. All units must be earthed in conformity with legislation in force in the country concerned.
-  18. Please attention that hot water produced by the unit is not to be used for drink.

Part II Installation

2.1 Transportation

Along transportation, don't incline the unit more than 45° in any direction

The unit in its packaging can be transported with a lift truck or hand truck.

2.2 Installation site requirement

This unit is designed for outdoor installation, do not install it in an close space.

Please consider the condition as following factors when selecting installation site.

- The installation site should be large enough and well ventilation.
- The installation site should be convenient for water drainage.
- Select a smooth, horizontal site where it can support the weight of the unit.
- Do not install the unit where there is pollution, accumulation, fallen leaves or bad ventilation.
- Don't install the unit near inflammable or explosive goods.

2.3 Minimum distance to wall

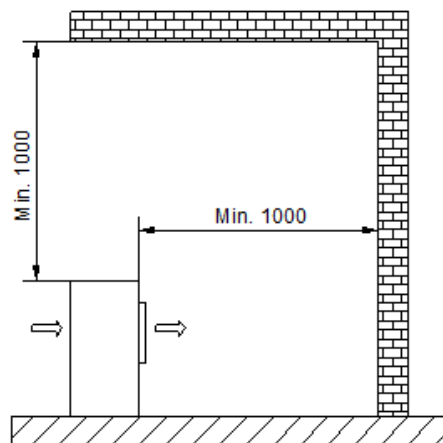
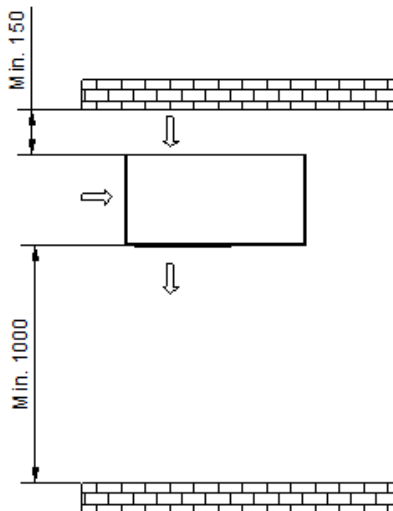
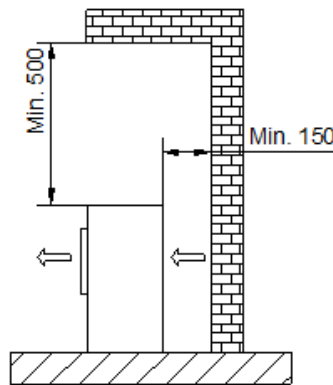
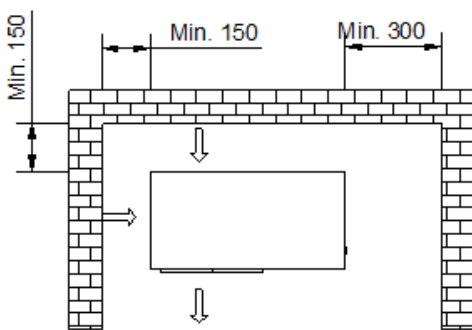

Air discharge

Min.1000 to obstacles obstructing the air discharge

Min.3000 to footpaths and patios due to the formation of ice, even when outside temperatures are above 0 °C

Clearance between outdoor module and ground

In areas with heavy snowfall, the minimum installation height must be increased or a canopy must be constructed over the outdoor module.

2.4 Installation guide

2.4.1 Installation

- a. Install 4 pieces shockproof rubber pad under the feet of the unit.
- b. If the unit work with a water tank, the vertical distance between the unit and the water tank should be less than 6m, and the horizontal distance should be less than 20m.
- c. Connect the condensate drainage connector to the hole at the bottom sheet.

2.4.2 Accessories

Accessories inside the package as below table

No	Item	Quantity
1	Instruction Manual	1
2	Condensate drainage connector	2
3	shockproof rubber pads	4

2.5 Recommended hydraulic connection

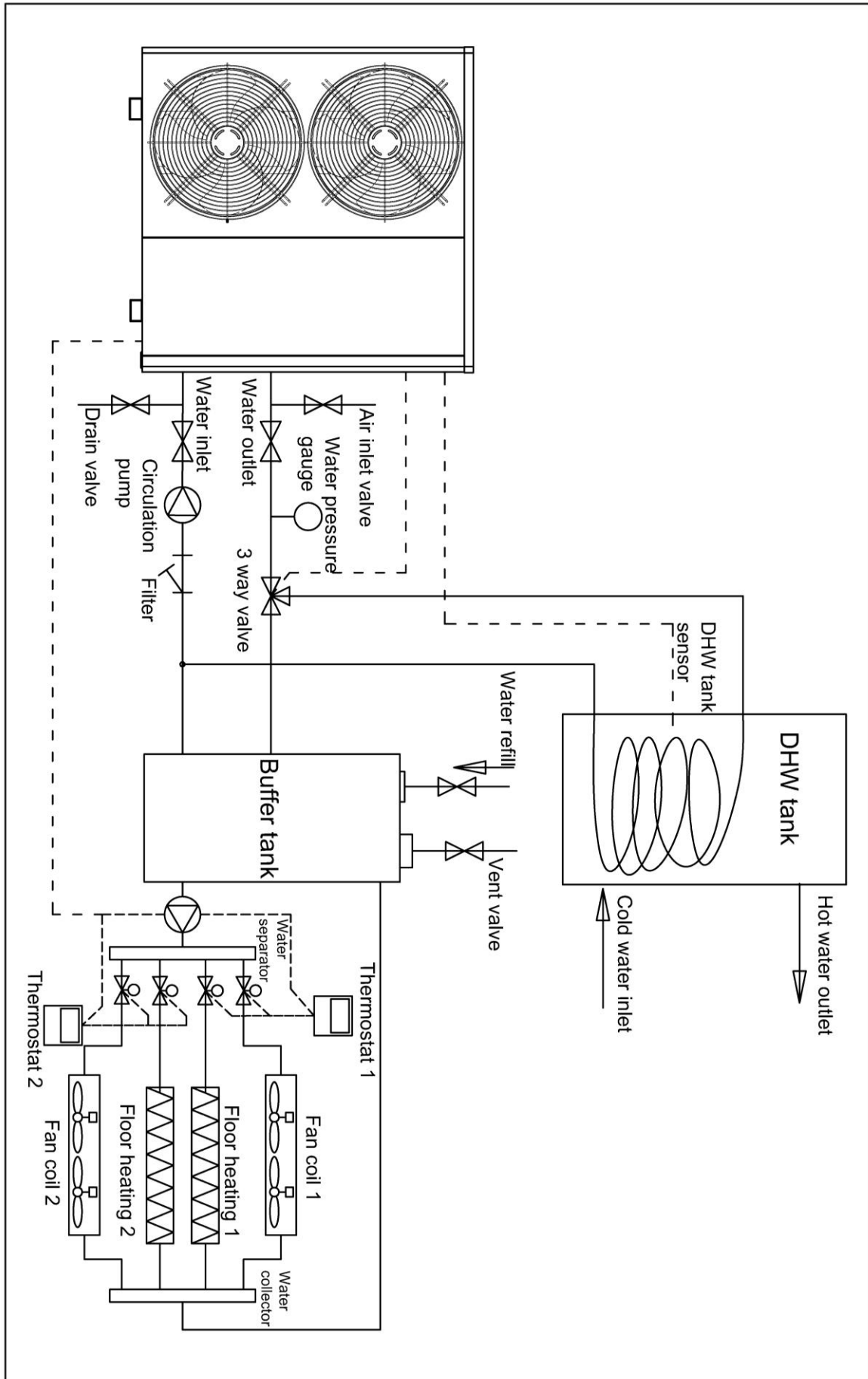

2.6 Electrical connection

1. Ensure proper operation of the unit, the unit must be installed and repaired by qualified technician.
 2. A leakage protection switch must be installed near the unit.
 3. Do not use any damaged cable and switch.
 4. Do not open the electrical box without shutting off all power to the unit.
- All the wiring must meet the local electrical safety norm and performed by qualified electricians.
 - Ensure that the heat pump water heater is well connected to the earth, do not disconnect the earth connection of the power in any condition.
 - Provide a separate power supply which meets rated requirements for the unit.
 - When the unit connects to the electricity network, there must be a short-circuit protection.
 - Choose the suitable cable when use the power outdoor.
 - Do not control the unit on or off by the main power switch.
 - After finish installation, check before connect the unit to the power.

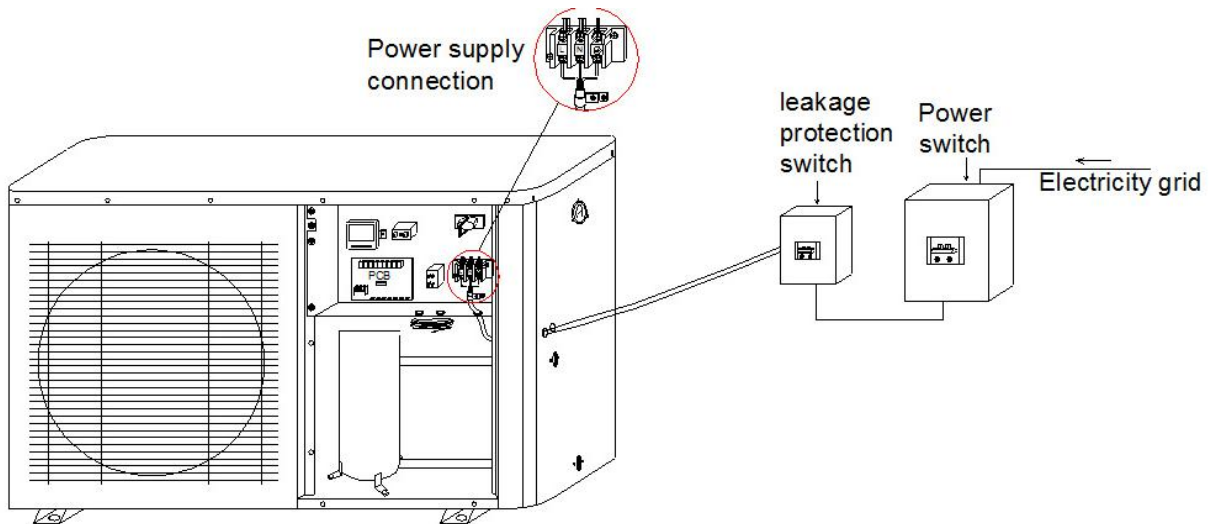

The Specification of Power

Following information is for reference, please subject to the local safety norm.

Type	GT-SKR020KB DC-M32	GT-SKR030KB DC-M32	GT-SKR040KB DC-M32	GT-SKR050KB DC-M32
Power supply	220-240V/1Ph/ 50Hz	220-240V/1Ph/ 50Hz	220-240V/1Ph/ 50Hz	380-415V/3Ph/ 50Hz
Circuit Breaker/Fuse(A)	25	32	40	32
Min. power wiring (mm ²)	2.5	4.0	4.0	2.5
Ground wiring (mm ²)	1.5	1.5	1.5	1.5

2.7 Trial operation

- The unit should only be operated by qualified technician.
- Please drain air inside hydraulic system before operation.
- The unit is designed according to the conditions as follows: the range of ambient temperature is $-20^{\circ}\text{C}\sim 43^{\circ}\text{C}$ and the range of water pressure is $0.15\sim 0.8\text{Mpa}$.

2.7.1 Preparation

The following items should be checked before startup:

- a. The heat pump should be connected completely.
- b. All valves that could impair the proper flow of the heating water in the heating circuit must be open.
- c. The air intake and air outlet paths must be cleared.
- d. The ventilator must turn in the direction indicated by the arrow.
- e. The settings of the heat pump controller must be adapted to the heating system in accordance with the controller's operating instructions.
- f. Ensure the condensate outflow functions.
- g. Drain the air inside hydraulic system.

2.7.2 Trial run

- Turn on the power, start up the unit by the controller, after 30 seconds, the unit (compressor) start to work, then observe whether the unit works normally.
- When you restart the unit, the compressor will start up after three minutes to protect the compressor.

2.7.3 Caution

When following happen during trial operation, please stop the unit immediately and cut off the power and contact with our authorized agent or maintenance technician.

Fuse blown or protection activated frequently

- The wire and switches are heated abnormally
- Abnormal sounds coming from the unit
- Abnormal smell comes out of the unit.
- Electricity leakage.

Part III Control System

3.1 Controller position

The controller is installed inside the unit before factory, open the front panel as following picture, you will find the controller.

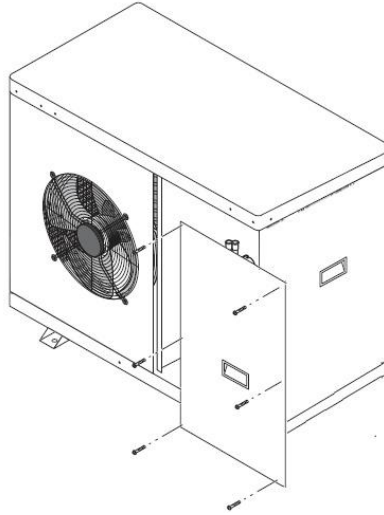

There is 8 meters cable for the controller, it is allowable to move the controller to outside the unit, but avoid a place with sunshine and rain.

3.2 Controller introduction

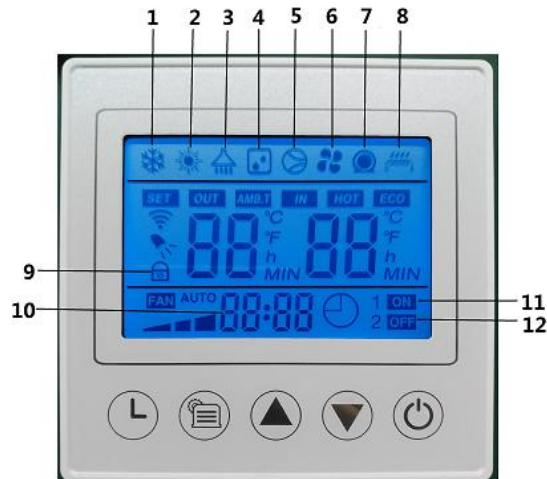



1	Cooling	7	Water pump
2	Heating	8	E-heater
3	DHW	9	Lock the keys
4	Defrosting	10	Clock
5	Compressor	11	Timer on
6	Fan	12	Timer off

3.3 Operation introduction

❖ Lock and unlock buttons

1. In locked status, press  button for 5 seconds, the buzzer will sound and unlock the buttons.
2. If there is no operation for 60 seconds, buttons will be locked automatically, and the backlight will be off.

❖ Turn on/Off the unit

1. When the buttons are locked,  displace on the screen, press  button for 5 seconds to unlock the screen;
2. In unlock status, press  button for 1 second to switch on/off;
3. In unlock status, if there is no operation on the controller for 60 seconds, the buttons will be locked automatically.

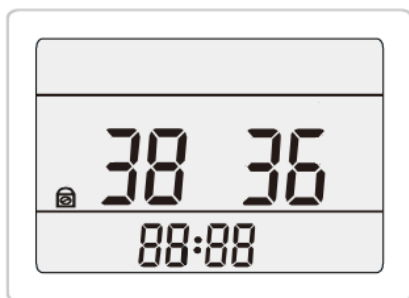



Standby status

❖ Function button

1. In main menu, press  button to switch working mode.
The units have 5 working modes as below:

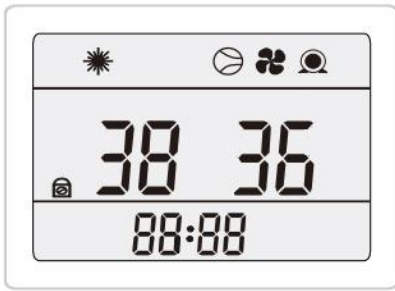

(1): Heating mode

The left side of the screen shows the set water temperature of buffer tank; The right side of the screen shows the measured water temperature of buffer tank. Press  or  to adjust the set water temperature of buffer tank, the maximum water temperature can be set is 60°C.



Heating status

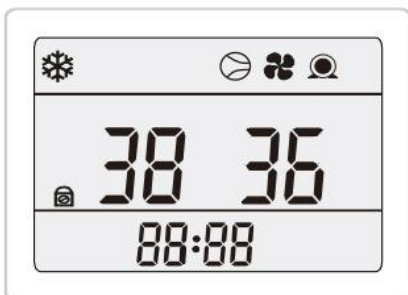

(2): cooling mode

The left side of the screen shows the set water temperature of buffer tank; The right side of the screen shows the measured water temperature of buffer tank. Press  or  to adjust the set water temperature of buffer tank, the minimum water temperature can be set is 8°C.



Cooling status

(3): DHW mode

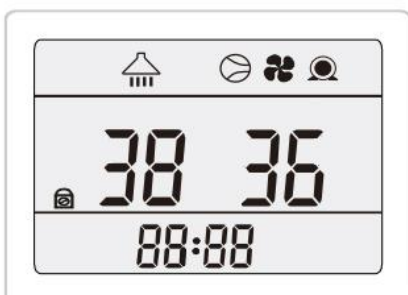

The left side of the screen shows the set DHW water temperature; The right side of the screen shows the measured DHW water temperature. Press  or  to adjust the set DHW water temperature, the maximum DHW water temperature can be set is 55°C.





DHW status

(4): heating + DHW mode (DHW priority)

-When the unit is in heating status,  flash on the screen, the left side of the screen shows the set water temperature of buffer tank; The right side of the screen shows the



measured water temperature of buffer tank. Press  or  to adjust the set water temperature of buffer tank, the maximum water temperature can be set is 60°C.

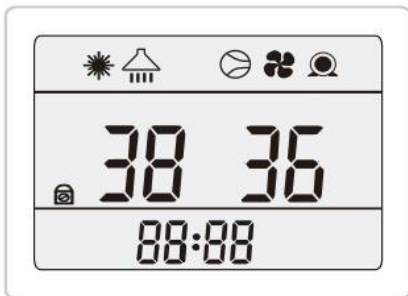

-When the unit is in DHW status,  flash on the screen, the left side of the screen shows the set DHW water temperature; The right side of the screen shows the measured DHW water temperature. Press  or  to adjust the set DHW water temperature, the maximum DHW water temperature can be set is 55°C.



Heating+ DHW status

(5): cooling + DHW (DHW priority)





-When the unit is in cooling status,  flash on the screen, the left side of the screen shows the set water temperature of buffer tank; The right side of the screen shows the measured water temperature of buffer tank. Press  or  to adjust the set water temperature of buffer tank, the minimum water temperature can be set is 8°C.

-When the unit is in DHW status,  flash on the screen, the left side of the screen shows the set DHW water temperature; The right side of the screen shows the measured DHW water temperature. Press  or  to adjust the set DHW water temperature, the maximum DHW water temperature can be set is 55°C.



Cooling+ DHW status





❖ Parameter inquiry

1. In main menu, press  button for 3 seconds to enter user parameter inquiry menu, press  or  button to inquire parameters.
2. In user parameter inquiry menu, if there is no operation for 30 seconds, will automatically exit user parameter inquiry and back to main menu. Or press  button to back to main menu.

Item	Description	Unit	Range	Remark
00	DHW tank temperature	°C	-30~105	
01	Frequency of compressor	Hz	0~99	
02	Current of compressor	A	-30~105	
03	DC bus voltage	V	-30~105	*10
04	Temperature of IPM module	°C	-30~105	
05	AC voltage	V	-30~105	*10
06	AC current	A	-30~105	
07	Current operating power of compressor	W	-30~105	*100
08	Fan speed	RPM	-30~105	*10
09	Target overheating of suction in main circuit	°C	-30~105	/10
10	Actual overheating of suction in main circuit	°C	-30~105	
11	EEV opening in main circuit	P	-30~105	*10
12	EEV opening in injection circuit	P		*10
13	High pressure	Kpa	-30~105	*100
14	High pressure saturated evaporation temperature	°C	-30~105	
15	Current exhaust superheat	°C	-30~105	
16	Low pressure in main circuit	Kpa	-30~105	*100
17	Low pressure saturated evaporation temperature	°C	-30~105	
18	Target overheating in auxiliary circuit	°C	-30~105	
19	Actual overheating in auxiliary circuit	°C	-30~105	
20	Low pressure in auxiliary circuit	KPa	-30~105	*100

21	Inlet temp of auxiliary circuit	°C	-30~105	Low pressure saturated evaporation temperature in auxiliary circuit
22	Outlet temp of auxiliary circuit	°C	-30~105	EVI suction temperature
23	Exhaust temp	°C	-30~140	
24	Outdoor coil temperature	°C	-30~105	
25	Outdoor environment temperature	°C	-30~105	
26	Buffer tank temperature	°C	-30~105	
27	Temperature of after throttling	°C	-30~105	
28	Inlet water temperature	°C	-30~105	
29	Outlet water temperature	°C	-30~105	
30	Suction temperature	°C	-30~105	
31	Cascade switch selection		0: OFF; 1: ON	
32	Cascade switch status		0: OFF; 1: ON	
33	Status of water pump		0:OFF; 1: ON	

❖ Defrosting parameters setting (only for technician operate)

1. In main menu, press  button for 3 seconds to enter parameter setting menu, press  or  button to set parameters. Press  button to save setting.

2. In parameter setting menu, if there is no operation for 30 seconds, will automatically exit parameter setting and back to main menu. Or press  button to back to main menu.



Item	Description	Default value	Unit	Range	Remark
b17	Set room temp	25	°C	15~25°C	For heating curve
b18	Initial BTW temp	20	°C	15~25°C	For heating curve
b19	Max. BTW temp	43	°C	24~50°C	For heating curve
b20	Extend defrosting interval 1	0	min	-30~50	value=x, interval time of defrosting=(60+x) mins.
b21	Extend defrosting interval 2	0	min	-30~50	value=x, interval time of defrosting=(60+x) mins.
b22	Defrosting enter temp 1	9	°C	-30~30	this value is temp difference (environment temp-coil temp)

b23	Defrosting enter temp 2	8	°C	-30~30	this value is temp difference (environment temp-coil temp)
b24	Defrosting running time	12	min	6~16	
b25	Defrosting exit temp 1	15	°C	12~25	
b26	Defrosting exit temp 2	5	°C	4~11	



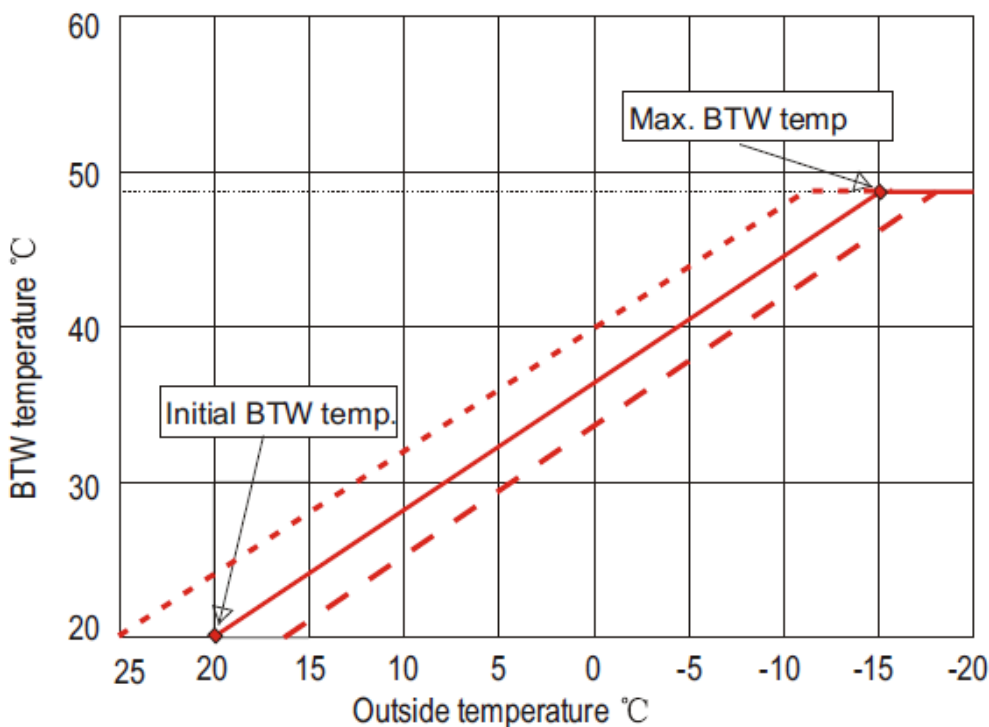



❖ Heating curve



The heating curve is the relationship between the heating system supply temperature and the outside air temperature. In the case of a heating curve, it is done automatically thanks to the weather-based control, which adjusts the supply temperature based on the outside temperature.













Press ,  and  buttons at the same time, **ECO** displace on the screen, the unit run according to heating curve. The parameter setting b17, b18 and b19 as above list.

❖ Clock setting



1. In main menu, press  button for 10 seconds to enter clock setting menu.
2. In clock setting menu, press  button, the hour flashes, press  or  to set the hour.
3. After the hour is set, press  button again, the minute flashes, press  or  to set the minute.

4. After the minute is set, press  button again to save the clock setting and back to main menu.
5. In clock setting menu, if there is no operation for 30 seconds, will automatically save clock setting and back to main menu.
6. In clock setting menu, press  button to save clock setting and back to main menu.



❖ **Timer setting**

1. In main menu, press  button to enter timer 1 setting.
2. In timer 1 setting, press  button again, hour of timer ON flashes, press  or  to set the hour of timer ON.
3. After the hour of timer ON is set, press  button again, the minute flashes, press  or  to set the minute of timer ON.
4. After the minute of timer ON is set, press  button again to enter hour setting of timer OFF, setting as timer ON.
5. After the timer OFF is set, press  button again to save timer 1 ON and OFF setting. And enter timer ON and OFF setting of timer 2. The setting is same as setting of timer 1.
6. In timer setting menu, press  button to cancel the current setting of timer ON/OFF.
7. In timer setting menu, if there is no operation for 30 seconds, will automatically save timer setting and back to main menu.
8. In timer setting menu, press  button to save timer setting and back to main menu.



❖ **Manual defrosting**

In ON status, press  and  button simultaneously for 5 seconds to enter manual defrosting,  displace on the screen.

❖ **Manual startup auxiliary electrical heating**

In ON status, press  and  button simultaneously for 5 seconds to enter / exit forced electric heating.

❖ Check background failure of protection 2

In On status, press  button for 10 seconds to check background failure of protection 2. It displays “----“ if there is no failure. Press  button to back to main menu.

❖ Wifi control

Scan the QR code to install the APP, after installing the APP, the software  will display on your mobile phone.





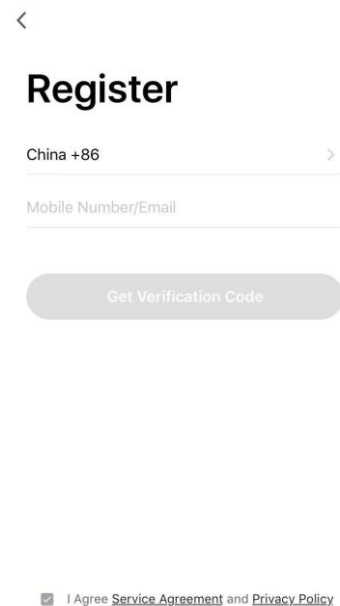
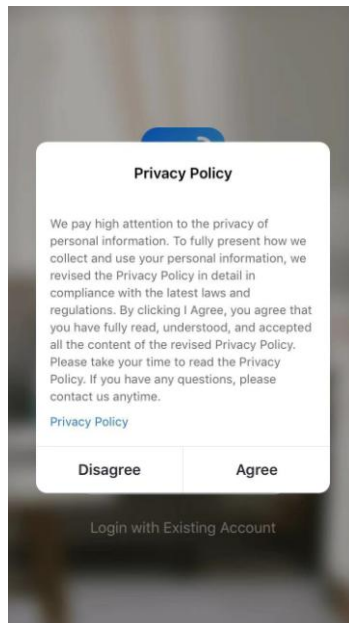
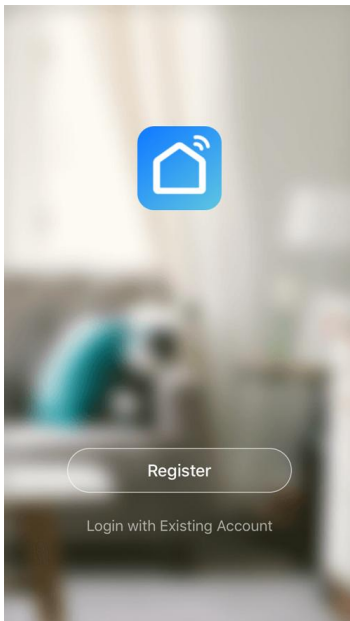

1. Software registration

Ensure the unit and mobile phone have connected to a wifi.

Please complete registration step by step if new user.



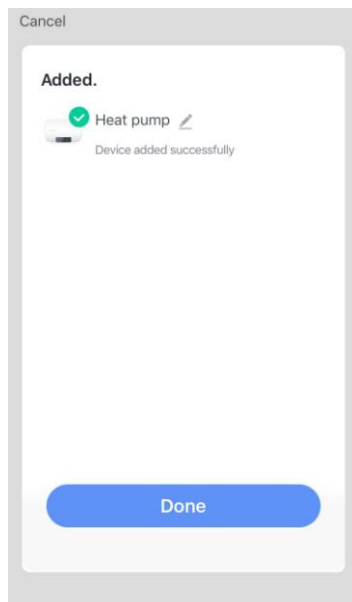
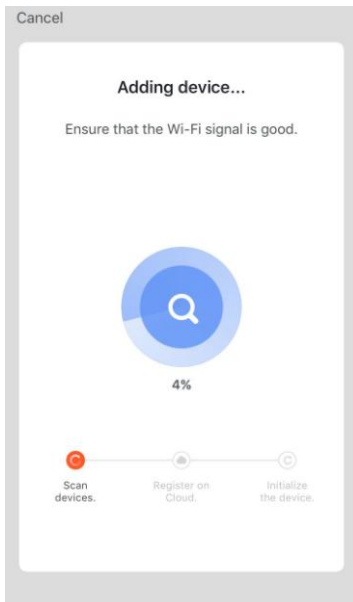
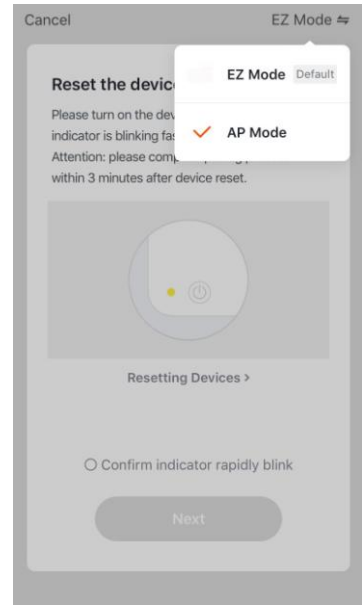
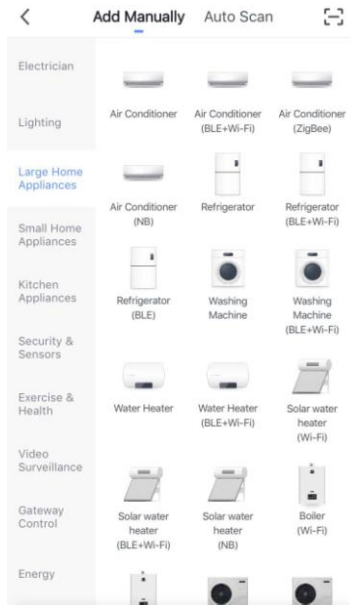
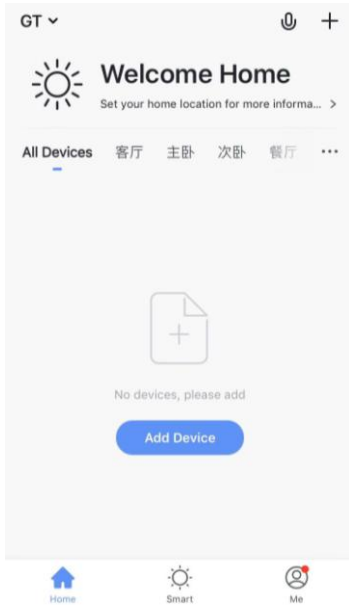

After registration is complete, please log in to the software by user name and password you have set, the heat pump and mobile phone should be connected to WIFI.

Extended press ,  and  at the same time,  flash on the screen, press ADD DEVICE on the APP on your mobile phone, choose LARGE HOME APPLIANCES on the menu, choose WATER HEATER on the list, next step, Select AP MODE in the upper right menu.



After connecting to the heat pump by AAP, the unit can be turned on/off by APP, can be set water temperature by APP, can be choose working mode by APP, can set timer by APP.

 : Turn on/off the unit

 : Set working mode

 : Set clock

Part IV Maintenance

Before performing any maintenance on the unit, you should turn the unit off first and shut off the power.

A well-maintained heat pump could save your energy costs and make the unit durable, but must be done by a qualified technician. Below are some tips for your reference to help your heat pump gives you optimum performance.

1. Turn the power off when the unit is being maintained.
2. Do not use petrol, naphtha, dissolvent and any other chemicals on the unit, otherwise, it may damage the surface. External heat pump parts can be wiped with a damp cloth and domestic cleaner.
3. Avoid leaning or putting objects on the device.
4. Keep dry and drafty round the unit. Clean heat exchangers regularly (usually once per 1~2 months) to keep a good heat exchange efficiency.
5. If the unit will be shut down for a long time, you should drain the water in the pipe, turn the power off and cover it with protective cover, Check it roundly before you start it again.
6. It is advised to use the phosphoric acid whose temperature is about 50~60°C and consistency is 15% to clean the heat exchanger of the unit. First start the circulation pump to clean it for 3 hours, and then flush it with tap water for three times. Do not use any amyctic detergent to clean the heat exchanger and the tank.
7. Change the installation place
If the customer wants to change the site, please contact with the dealer or the local Customer Service for help.

Part V Trouble Shooting

Type	Code	Description	Remark
Failure (Display on screen)	F0	Communication failure between PCB and driver board	
	F1	Communication failure between controller and PCB	
	F2	Abnormal start of compressor (Open-phase, reverse rotation)	
	F3	Out of step of compressor	
	F4	IPM module failure	
	F6	Outdoor DC fan failure	
	E0	Inlet water temp sensor failure	
	E1	Outlet temp sensor failure	
	E2	After throttling temp sensor failure	
	E3	Air suction temp sensor failure	
	E4	Outdoor coil temp sensor failure	
	E5	Outdoor environment temp sensor failure	
	E6	Exhaust temp sensor failure	
	E7	EVI return circuit air return temp sensor failure	
	E8	High pressure sensor failure	Valid when there is pressure sensor
	E9	Low pressure sensor failure	Valid when there is pressure sensor
	EA	Economizer inlet temp sensor failure	
	EB	Indoor environment temp sensor failure	
	EC	Economizer outlet temp sensor failure	EVI return circuit low pressure
	ED	Buffer tank sensor failure	
EH	DHW water tank sensor failure		
EE	Main board EE failure		
EF	Driver board EE failure		

Protection1 (Display on screen)	P7	High pressure switch protection	
	P8	Low pressure switch protection	
	PC	Water flow switch off protection	
	PD	High pressure protection	
	PE	Low pressure protection	
	H1	Temp difference between water inlet and water outlet is too high	
Protection2 (Check in the background)	F5	Overheat protection of compressor	
	P1	AC current protection of outdoor unit	
	P2	Current protection of compressor	
	P3	AC voltage too high / too low protection of outdoor unit	
	P4	DC bus voltage too high / too low protection	
	P5	IPM overheat protection	
	P6	Overheat protection of exhaust temp	
	P9	Overheat protection of outer coil in cooling	
	PH	Environment temp is too high in heating	
	PA	Anti-freezing protection of inner coil in cooling	
	H2	Compressor starting pressure difference protection	
	H3	Compressor running pressure difference protection	
	PB	Overheat protection of inner coil in heating	

The possible causes and treatment of common failure.

Fault Condition	Possible Causes	Treatment
The unit doesn't work	<ul style="list-style-type: none"> ◇ Power fault ◇ Bad connection to the power ◇ Fuse blow 	<ul style="list-style-type: none"> ◇ Turn off the switch, check the Power source ◇ Find the causes and renovate them ◇ Replace the fuse
The pump is working but too noisy and the water is not cycled	<ul style="list-style-type: none"> ◇ Lack water In the system ◇ There is air in the water circulation ◇ Any valve in the system is not open ◇ Filter stoppage 	<ul style="list-style-type: none"> ◇ Check the water make-up device and fill in with water ◇ Discharge the air in water system ◇ Open all valves ◇ Clean filters
Low heating capacity	<ul style="list-style-type: none"> ◇ Inadequate refrigerant ◇ bad insulation of the water system ◇ Drying filter stoppage ◇ Air side heat exchanger is un-efficient ◇ Inadequate water-flow 	<ul style="list-style-type: none"> ◇ Leak hunting and fill in standard quantity of refrigerant ◇ Improve the heat insulation ◇ Replace the drying filter ◇ Clean the heat exchanger ◇ Clean the water filter
The compressor doesn't work	<ul style="list-style-type: none"> ◇ Power failure ◇ Compressor contactor destroyed ◇ Poor connection ◇ Overheating protection ◇ water outlet temperature is too high ◇ Inadequate water-flow 	<ul style="list-style-type: none"> ◇ Check it and solve the problems ◇ Replace contactor ◇ Check and renovate it ◇ Check and solve the problems ◇ Reset a proper temperature ◇ Clean the water filter and discharge the air in the water system
The compressor works but too noisy	<ul style="list-style-type: none"> ◇ Liquid refrigerant goes into the compressor ◇ interior components destroyed ◇ Inadequate refrigeration oil 	<ul style="list-style-type: none"> ◇ Check the expansion valve ◇ Replace the compressor ◇ Add in adequate refrigeration oil

The fan doesn't work	<ul style="list-style-type: none"> ◇ Capacitor damaged ◇ The fans are not fixed well ◇ The electromotor burned out ◇ Contactor destroyed 	<ul style="list-style-type: none"> ◇ Replace it ◇ Fix it well again ◇ Replace the electromotor ◇ Replace the Contactor
Compressor works but not heating	<ul style="list-style-type: none"> ◇ Refrigerant leakage ◇ Compressor fault 	<ul style="list-style-type: none"> ◇ Leak hunting and fill in standard quantity of refrigerant ◇ Replace the compressor
Low water-flow protection	<ul style="list-style-type: none"> ◇ Hydraulic switch destroyed ◇ Inadequate water-flow 	<ul style="list-style-type: none"> ◇ Replace the switch ◇ Clean the filter and discharge the air
Excessive discharge pressure	<ul style="list-style-type: none"> ◇ Too much refrigerant ◇ Non-condensable gas in the Refrigeration cycle ◇ Inadequate water-flow 	<ul style="list-style-type: none"> ◇ Draw off the superfluous refrigerant ◇ Drive the gas out ◇ Check the circulation and increase the flow
Low suction pressure	<ul style="list-style-type: none"> ◇ Drying filter stoppage ◇ Lack of refrigerant ◇ Excessive pressure drop in the heat exchanger 	<ul style="list-style-type: none"> ◇ Replace the filter ◇ Leak hunting and fill in standard quantity of refrigerant ◇ Check the opening of electronic expansion valve

Part VI Wiring Diagram

GT-SKR020KBDC-M32, GT-SKR030KBDC-M32

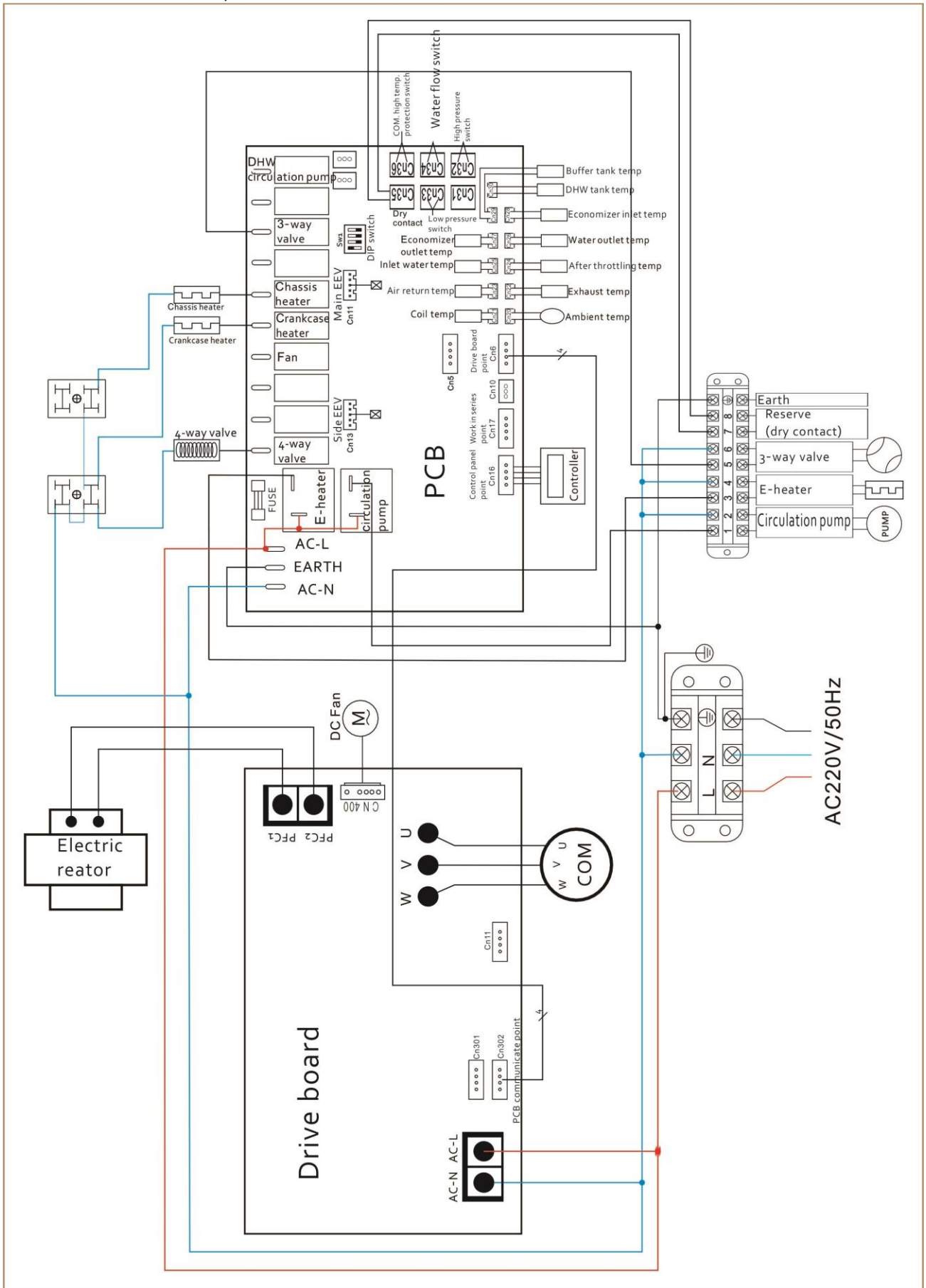

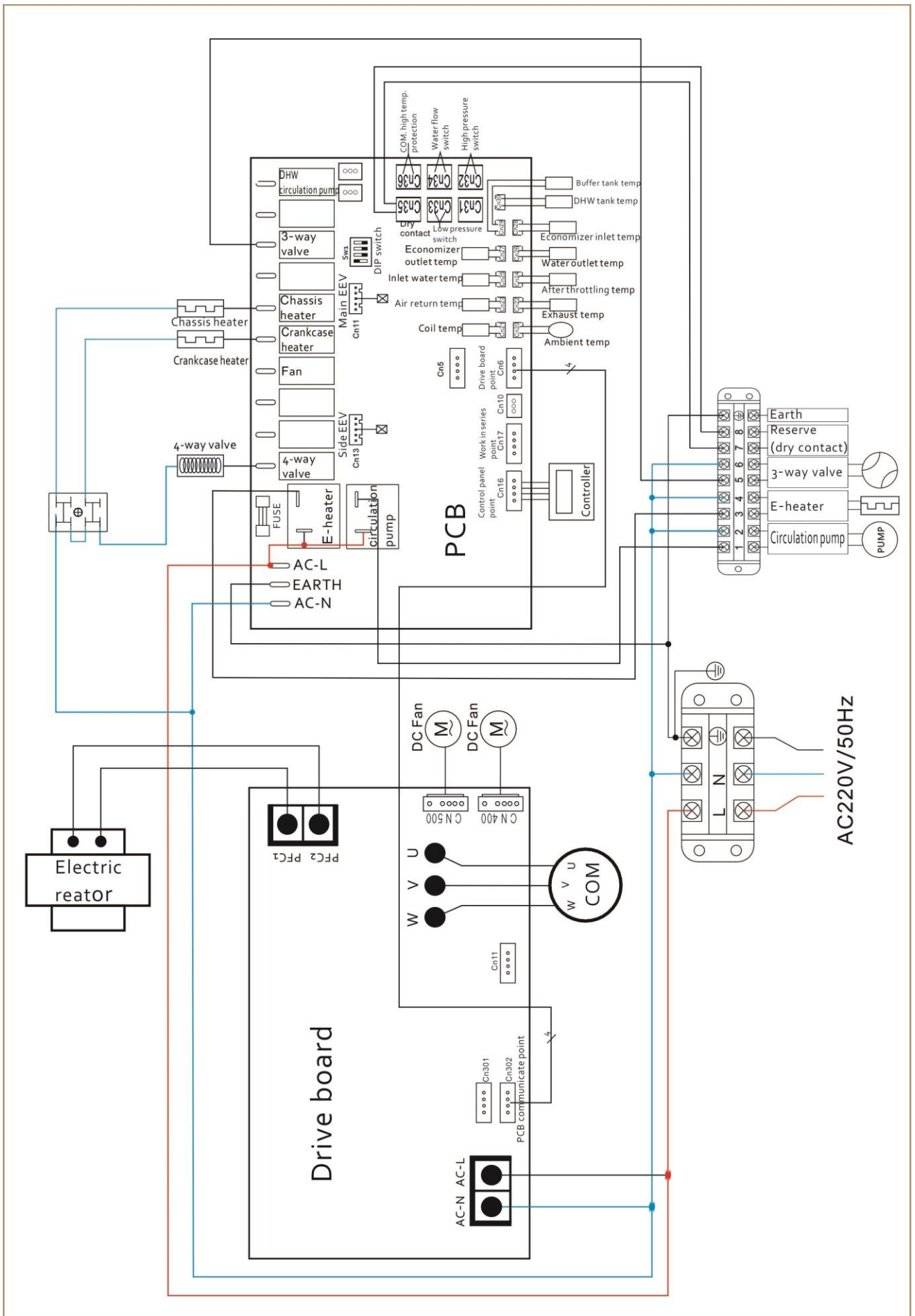

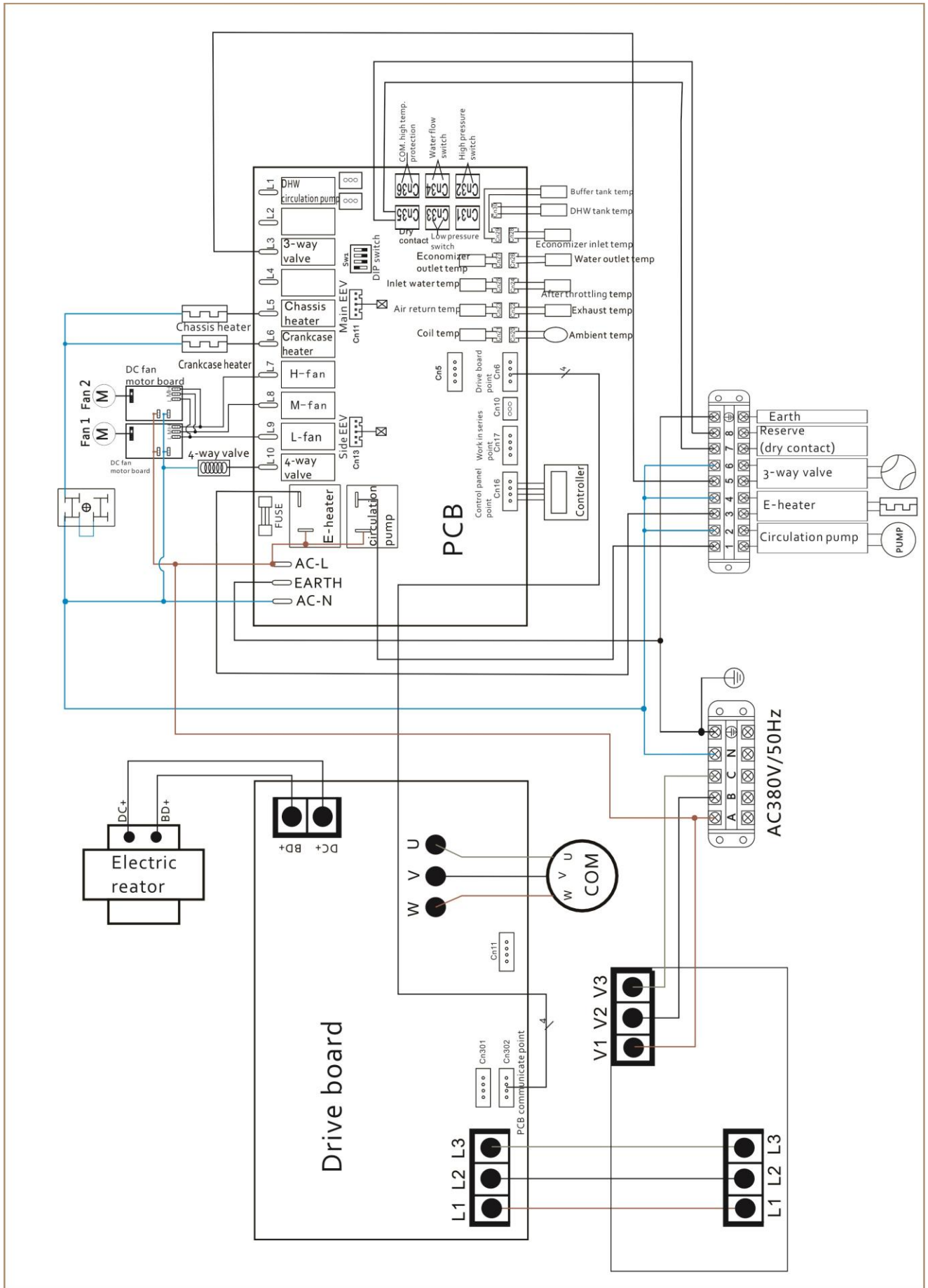

Disposal

Do not dispose this product as unsorted municipal waste. Collection of such waste separately for special treatment is necessary.

Do not dispose of electrical appliances as unsorted municipal waste, use separate collection facilities.

Contact your local government for information regarding the collection systems available. If electrical appliances are disposed of in landfills or dumps, hazardous substances can leak into the groundwater and get into the food chain, damaging you health and well-being.



There won't be a further notice if anything changes as the unit improved.

If there is anything difference with rating label, please subject to the rating label on the unit.