

4. Install the leg pads (H), connect leg pads with ground by the inflated bolt. Fix it more than 4 steel ropes to avoid the demolition from the strong wind.

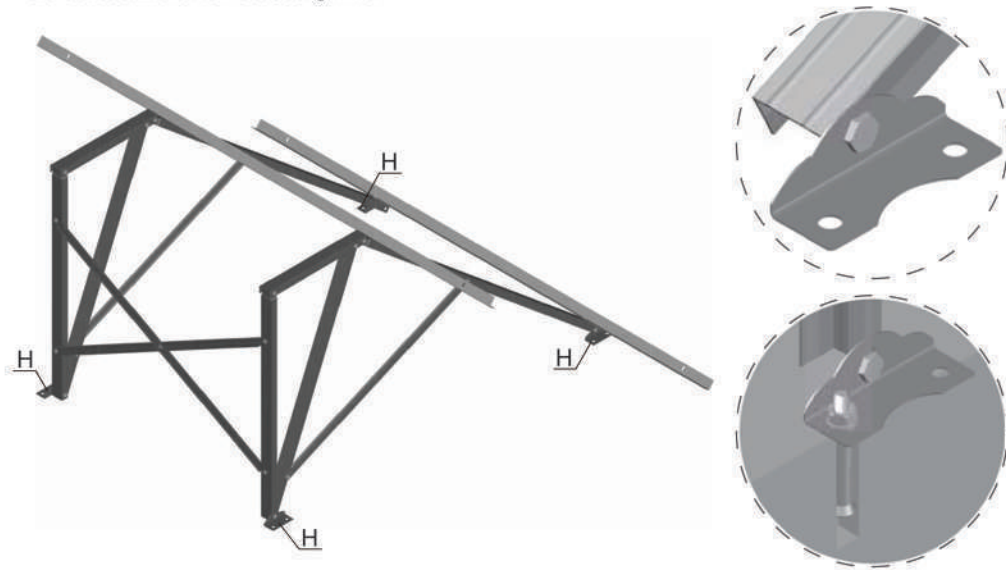

Support size

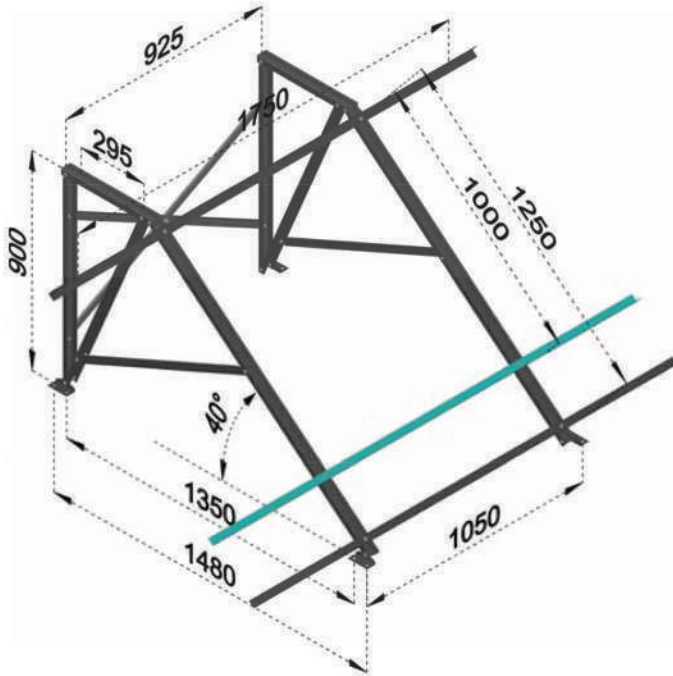





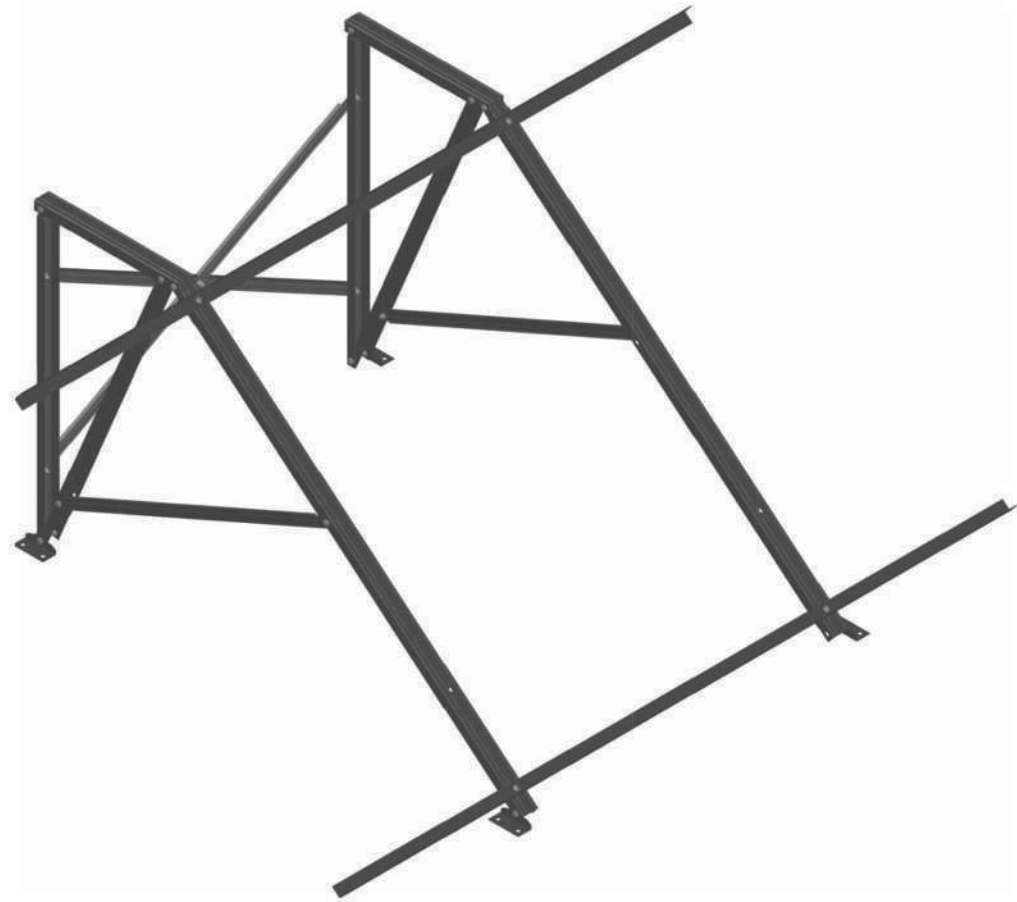



SunTech

1x2 m² and 2,5m² Horizontal



Parts list of support

A			
B			
C			
D			
E			
F			
G			
H		I	

Install on flat roof

1. Install the cross bars (A), rear legs (B), side rear legs (C), front legs (D) and the side drawbars (E).

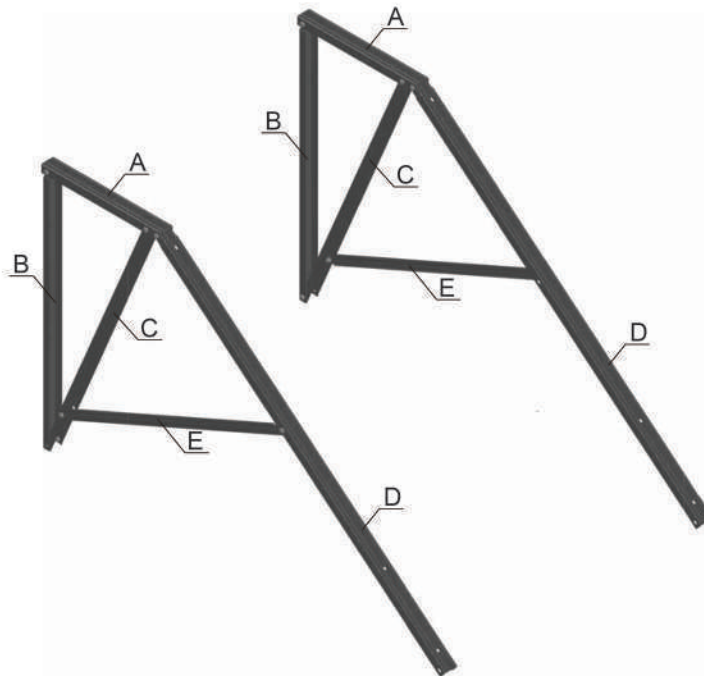

2. Install cross bars (F) between the rear legs (B) to create an "X".

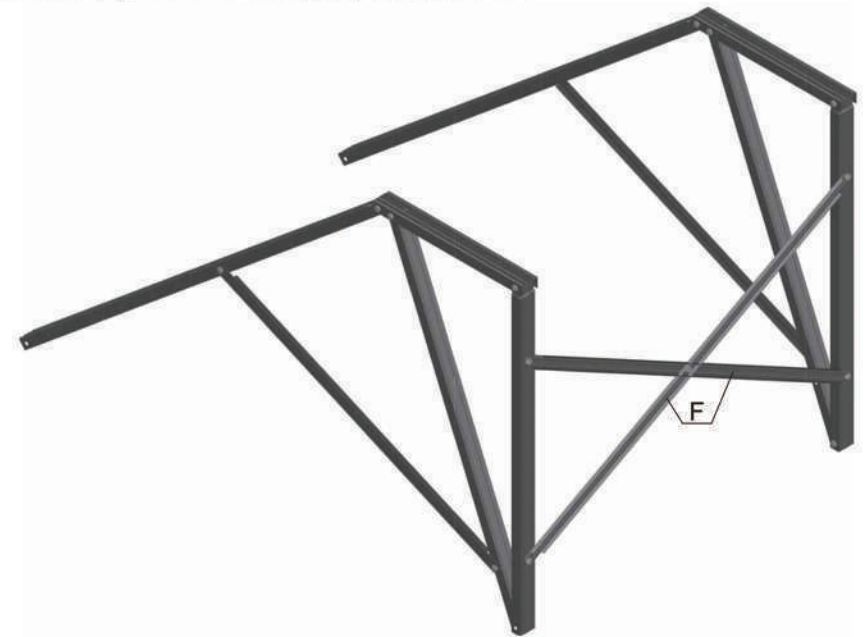

3. Install top plate (G) on the front legs (D).

